



LOWENER



AUTOMECHANIKA FRANKFURT

TILBUD 2025

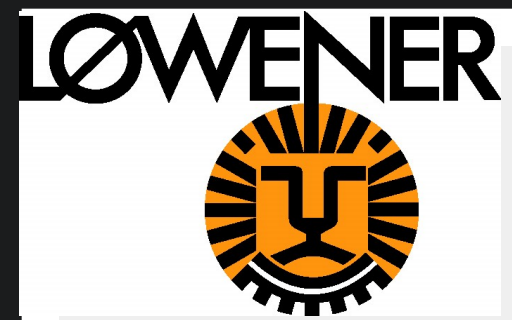

While stock lasts

106 - 5m

Price/Code includes:

- Bench with rack gears
- Lift with control box
- Pulling Column
- Universal Jig System
- Positioning and ascending ramps
- Pulling kit
- Racks kit
- Set of special hardened bolts
- Loading trolley
- McPherson Measuring System

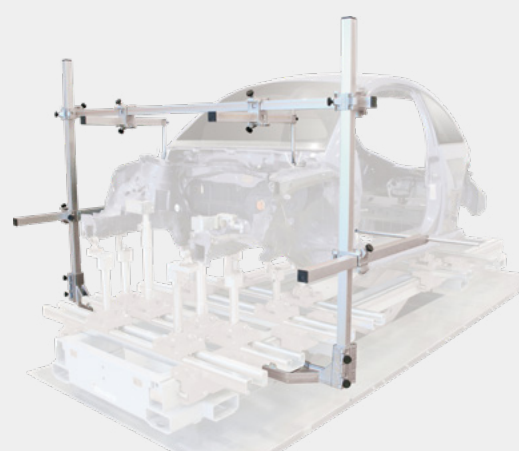
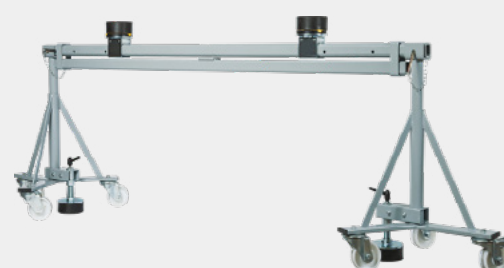
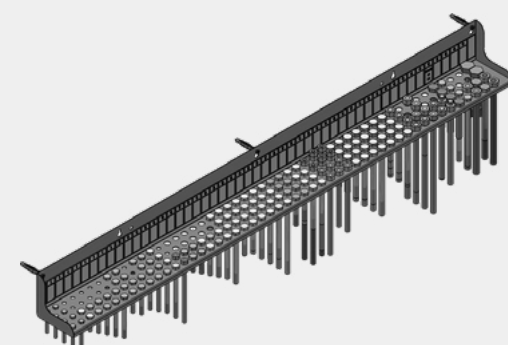
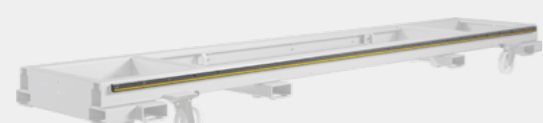
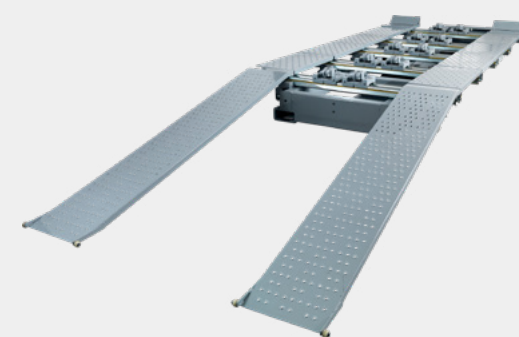
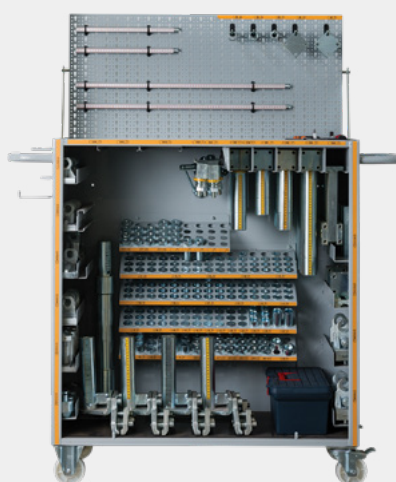

~~800.470,00 kr.~~ - Price list

288.170,00 kr. - Promo Price

BROCHURE

WATCH THE VIDEO

BACK TO INDEX

- Validity of the prices: 31st December 2024
- Delivery time: to be confirmed according to availability.



While stock lasts

106 - 6m

Price/Code includes:

- Bench with rack gears
- McPherson Measuring System
- Lift with control box
- Pulling Column
- Universal Jig System
- Positioning and ascending ramps
- Pulling kit
- Crossbar length 1800mm with no.02 sliding supports
- Racks kit
- Kit of special screws for jig complete with shelves
- Loading trolley
- Extension for ramps



~~968.825,00~~ kr. - Price list

348.780,00 kr. - Promo Price

[BROCHURE](#)

[WATCH THE VIDEO](#)

[BACK TO INDEX](#)

- Validity of the prices: 31st December 2024
- Delivery time: to be confirmed according to availability.



While stock lasts

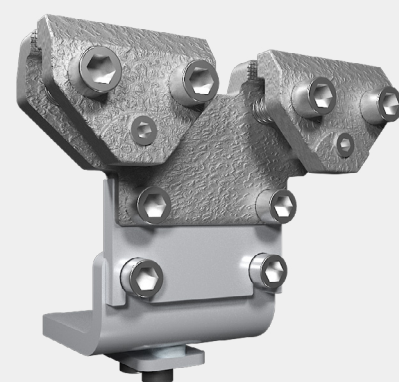

Minibench Maxiplus

Cod. 90MINOSA73

Min. 3 Units

Price/Code includes:

- Minibench Maxiplus with Electrohydraulic scissor lift
- 4 sliding platforms
- 4 support buffers
- 4 standard clamps
- Pulling column
- Control box

~~256.110,00 kr.~~ - Price list

89.430,00 kr. - Unitary Price

BROCHURE

WATCH THE VIDEO

- Validity of the prices: 31st December 2024
- Delivery time: to be confirmed according to availability.



While stock lasts

Multibench P3

Cod. 90MINOSA44

Price/Code includes:

- Multibench with Electrohydraulic scissor lift
- 12 sliding platforms
- 4 universal clamps
- Pulling column
- Control box

~~360.595,00~~ kr. - Price list

129.815,00 kr. - Promo Price

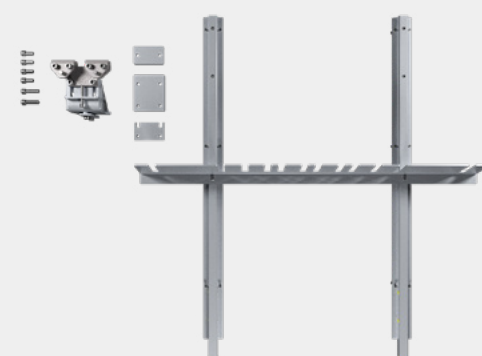
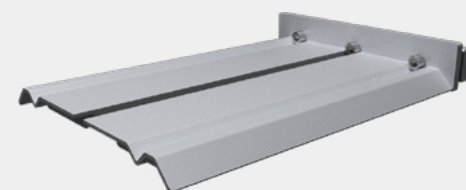
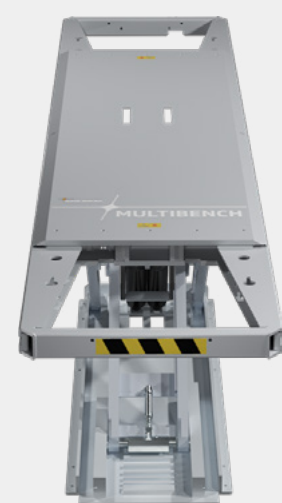

[BROCHURE](#)

[WATCH THE VIDEO](#)

[BACK TO INDEX](#)

- Validity of the prices: 31st December 2024
- Delivery time: to be confirmed according to availability.



Multibench P4

Cod. 90MINOSA44

Price/Code includes:

- Multibench with Electrohydraulic scissor lift
- 12 sliding platforms
- Clamp kit for high profile / 4WD vehicles
- 4 universal clamps
- Pulling column
- Control box
- Kit of 4 tripod-trolleys (3 wheels) - h 1250

~~424.190,00 kr.~~ - Price list

152.715,00 kr. - Promo Price

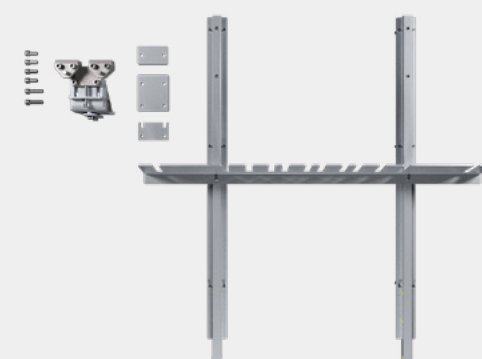
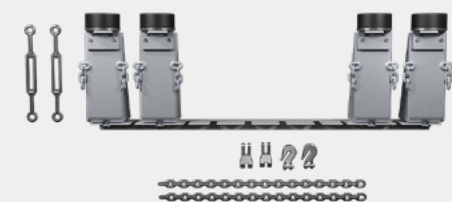
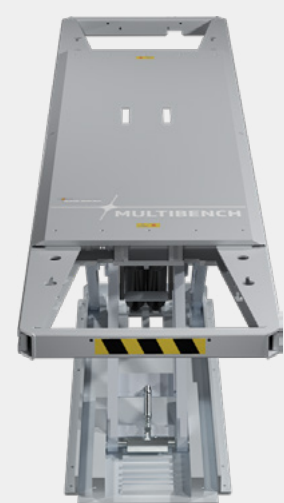

[BROCHURE](#)

[WATCH THE VIDEO](#)

[BACK TO INDEX](#)

- Validity of the prices: 31st December 2024
- Delivery time: to be confirmed according to availability.



While stock lasts

Multibench P6

Cod. 90MINOSA44

Price/Code includes:

- Multibench with Electrohydraulic scissor lift
- Control box
- Pulling Column
- 12 sliding platforms
- Clamp kit with SUV extensions
- Universal bracket trolley
- Kit of special screws
- Kit of supports and crossbars
- 4 Sliding bases
- Kit of 4 trolleys

~~579.250,00 kr.~~ - Price list

208.530,00 kr. - Promo Price

[BROCHURE](#)

[WATCH THE VIDEO](#)

[BACK TO INDEX](#)

- Validity of the prices: 31st December 2024
- Delivery time: to be confirmed according to availability.



Touch 4.0

Cod. 90TOUCP220

Touch allows measuring of:

- Vehicle frame and structural items
- Mechanical parts
- User added points with photos
- Suspension parts
- Comparative measurements

~~352.510,00~~ kr. - Price list

123.750,00 kr. - Promo Price

[BROCHURE](#)

[WATCH THE VIDEO](#)

[BACK TO INDEX](#)

- Validity of the prices: 31st December 2024
- Delivery time: to be confirmed according to availability.



Touch Portable

Cod. 90TOUCP120

Touch allows measuring of:

- Vehicle frame and structural items
- Mechanical parts
- User added points with photos
- Suspension parts
- Comparative measurements

~~325.670,00~~ kr. - Price list

93.500,00 kr. - Promo Price

[BROCHURE](#)

[WATCH THE VIDEO](#)

[BACK TO INDEX](#)

- Validity of the prices: 31st December 2024
- Delivery time: to be confirmed according to availability.

While stock lasts



Flash

Cod. 90STR00010

Price/Code includes:

- Flash Pulling System

~~15.015,00 kr.~~ - Price list

5.405,00 kr. - Unitary price min 10 units

[BROCHURE](#)

[WATCH THE VIDEO](#)

[BACK TO INDEX](#)

- Validity of the prices: 31st December 2024
- Delivery time: to be confirmed according to availability.

While stock lasts



PULL UP! Light

Cod. 90PULUP060

Price/Code includes:

- 5 Sliding Hammers
- 60 Shaped suction cups
- 32 Thread pivots
- 1 Glue gun ø 15mm 450w
- 5 Kg glue sticks

~~65.285,00 kr.~~ - Price list

26.115,00 kr. - Promo Price

[BROCHURE](#)

[WATCH THE VIDEO](#)

[BACK TO INDEX](#)

- Validity of the prices: 31st December 2024
- Delivery time: to be confirmed according to availability.

While stock lasts

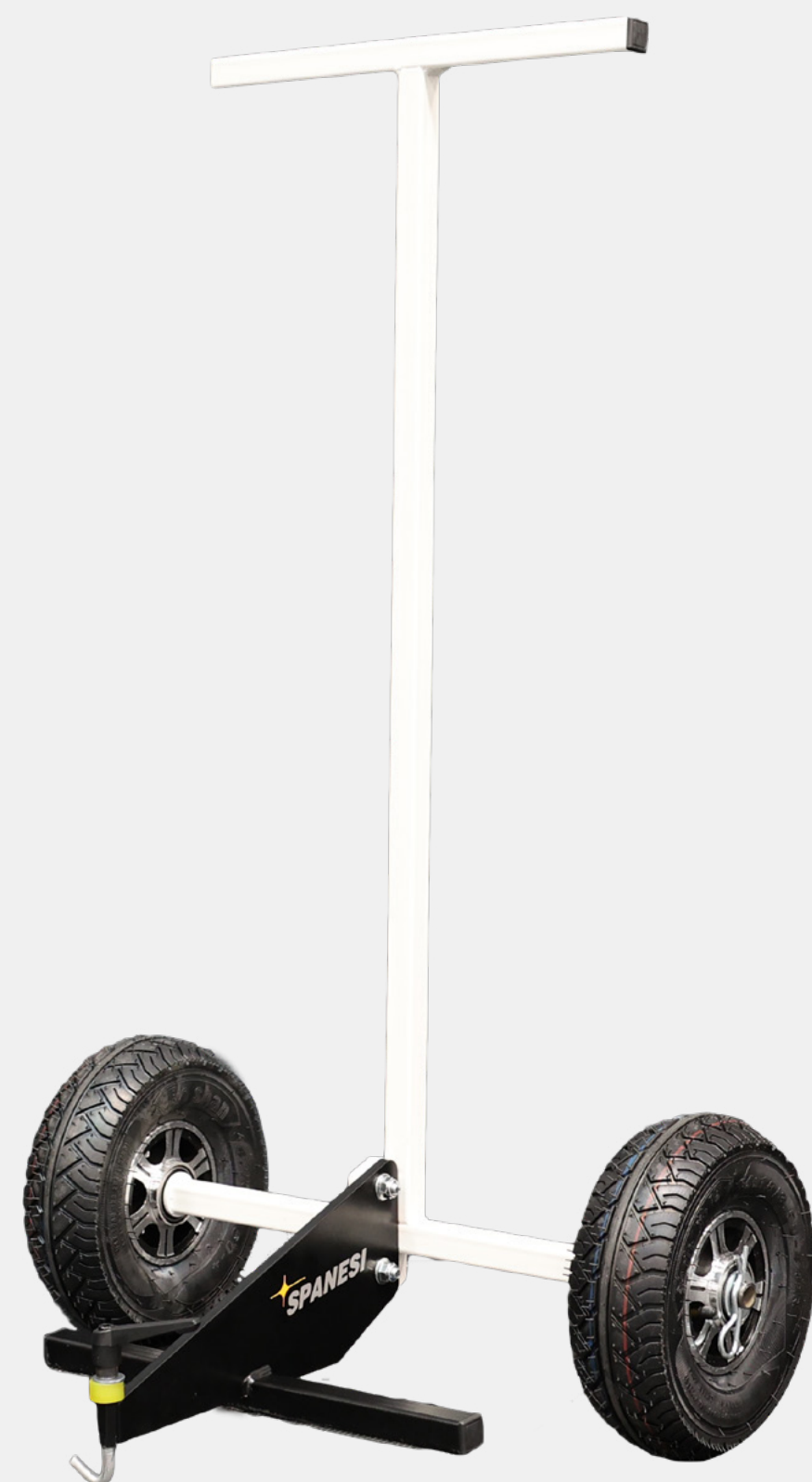

Buddy

Cod. 91CARRP030

Price/Code includes:

- trolley for moving grids

01 to 10 units:.....**1.299 kr.** - Net Price

from 11 units onwards:.....**1.099 kr.** - Net Price

[WATCH THE VIDEO](#)

[BACK TO INDEX](#)

- Validity of the prices: 31st December 2024
- Delivery time: to be confirmed according to availability.

Alle priserne er ekskl. moms, levering og opsætning
Gælder til og med 31.1.2025

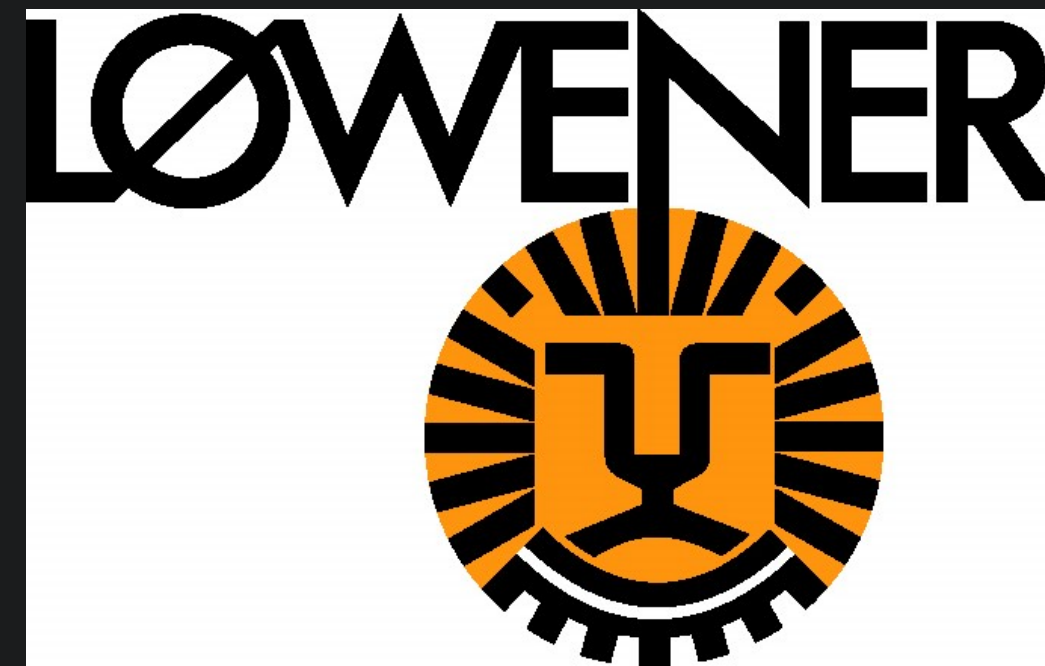

Spanesi S.p.A.

Via Praarie 56/II
35010 San Giorgio delle Pertiche PD
tel +(39) 049 933 32 11
www.spanesi.com - info@spanesi.it