



INVEST IN THE FUTURE



French manufacturer  
since 1964

Celebrating

60

years of innovation

1964 - 2024

# Car Body Welding Systems

Catalogue Carrosserie

Catalogo Carrozzeria

Karosserie-Schweißtechnik Katalog

Catálogo de Soldadura para Carrocería

2024



SPOT WELDING - DENT PULLER - MIG-MAG/GMAW-FCAW - PLASMA CUTTING -  
INDUCTION - RIVETING - LIFT - BODYSHOP TOOLS

## A solid manufacturing group

900 people € 130 000 000

C1+ Credit Rating Banque de France  
55 000 m<sup>2</sup> 2 factories



INVEST IN THE FUTURE



French manufacturer since 1964

## A family company



Nicolas & Bruno Bouygues

## 3 catalogues

3 500+ references



Welding, Plasma cutting & Induction heating



Car Body Welding Systems



Chargers, Boosters & Starters

## A worldwide coverage

125 countries



GYS FRANCE  
Laval

GYS GERMANY  
Aachen

GYS U.K.  
Rugby

GYS CHINA  
Shanghai

GYS ITALIA  
Venezia

GYS IBERICA  
Madrid

www.gys.fr



visit with



## DENT PULLING

GYS POT	6
GYS POT PRO	7
GYS POT ALU	8
GYS POT COMBI	9
ACCESSORIES & CONSUMABLES	10
GYS POT ARCPULL	12
COMBI ARCPULL	13
ACCESSORIES & CONSUMABLES	16
FAST EASY TOOLS	18
ACCESSORIES LEVELLING BARS	20
COMPLETE WORKSTATIONS	24

## PULLING SYSTEMS

AIRFIX DRAW ALIGNER	39
DRAW ALIGNER	40
FRAME STRAIGHTENING	42

## PAINTLESS DENT REPAIR

POWERDUCTION AUTO DENT REPAIR	46
GLUE PULLING KITS	50

## SPOT WELDING

TECHNOLOGY	54
PORTASPOT / GYS POT 32D-X / 100R-CX	56
GYS POT BP-LX	58
GYS POT PTI-S7	59
GYS POT BP GENIUS	62
GYS POT PTI PREMIUM PRO	64
GYS POT PTI GENIUS	66
G ARMS	68
ACCESSORIES & CONSUMABLES	69

## RIVETING

GYS PRESS 10T	71
GYS PRESS PREMIUM 10T PP	73
WORKSTATION	74
ADAPTERS	76
DIES BOXES & RIVETS	78
ACCESSORIES	81

## MIG WELDING

GYS AUTO	84
E GYS AUTO	86
AUTOPULSE	88
TORCHES & CONSUMABLES	92

## PLASMA

EASYS CUT	98
CUTTER	99

## INDUCTION HEATING

GYS DUCTION	102
COMBIDUCTION	103
POWERDUCTION	104
ACCESSORIES & CONSUMABLES	105

## TRUCK TOOLS & MOBILE LIFTS

TROLLEY IW1 / MULTITool TRUCK	111
SPOT LIFT	112
QUICKLIFT / MANUAL WHEEL LIFT	114
ERGO LIFT	115

## ACCESSORIES

WELDING HELMETS	118
FUME EXTRACTION	121
WINDSCREEN REPAIR	122
BUMPER REPAIR	124
HAND TOOLS	126
PNEUMATIC TOOLS	128
SANDING & DUST EXTRACTION	130
WORKING LIGHTS	132
WORKING SUPPORTS	134
SAFETY PROTECTION	137



# DENT PULLING

## STEEL / ACIER / STAHL

GYSPOT	6
--------	---

GYSPOT PRO	7
------------	---

## ALU

GYSPOT ALU	8
------------	---

## ALU + STEEL / ACIER / STAHL

GYSPOT COMBI	9
--------------	---

ACCESSORIES & CONSUMABLES	10
---------------------------	----

## DRAWN ARC

### ALU + STEEL / ACIER / STAHL

GYSPOT ARCPULL	12
----------------	----

COMBI ARCPULL	13
---------------	----

ACCESSORIES & CONSUMABLES	16
---------------------------	----

FAST DENT PULLING	18
-------------------	----

LEVELLING BARS	20
----------------	----

COMPLETE WORKSTATIONS	24
-----------------------	----





GYS POT ALU

# DENT PULLING ALU



SYNERGIC CONTROL

PATENTS REGISTERED NUMBERS  
EUROPEAN TRADEMARK & DESIGN



Goujons - Studs

NEW 03/2024



FIXED GUN

GYSPOT ALU 66

13000 A x1 AUTOMATIC

230V · 1~

080188

included for Ø 4 mm



Automatic alu gun  
3 m, 25 mm<sup>2</sup>

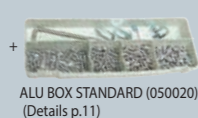

ALU BOX STANDARD (050020)  
(Details p.11)

GYSPOT ALU PRO FV

13000 A x1 AUTOMATIC

110 · 230V · 1~

021990

included for Ø 4 mm



Automatic alu gun  
3 m, 25 mm<sup>2</sup>

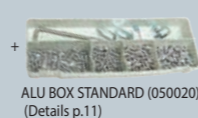

ALU BOX STANDARD (050020)  
(Details p.11)

FV FLEXIBLE VOLTAGE

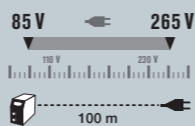

ALU GUN

AUTOMATIC



3 m, Ø 25 mm<sup>2</sup>

included SPOT ALU FV  
& COMBISLOT 230

054066



(x 3)  
065635

66 mF CAPACITOR DISCHARGE WELDING

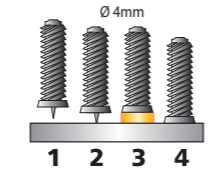

Joint rings for mandrel Ø 4/5/6  
x 2  
060814

OPTIONS

Consumables - Consommables  
p.11



ALU accessories - Accessoires ALU  
p.19



Trolleys - Chariots  
p.24



GYS POT COMBI

# DENT PULLING ALU+STEEL ACIER - STAHL

PATENTS REGISTERED NUMBERS  
EUROPEAN TRADEMARK & DESIGN

Steel / Acier / Stahl

Alu



- Stars - Étoiles
- Rings - Anneaux
- Wavy wires - Fils ondulés
- Impact shrinking - Rabattage d'impact
- Tempering - Rétreinte
- Rivets - Rivets
- Rings - Rondelles
- Studs - Goujons

2 GUNS INCLUDED



GUN WITH CONNECTOR

GYSPOT COMBI 230 E.PRO

3800 A Acier / Steel / Stahl

13000 A Alu

230V · 1~



AUTOMATIC

MANUAL

x2

AUTOMATIC

021266

included



Manual quick gun, 2 m, 70 mm<sup>2</sup> (057524)  
+ Hammer (057272)



Automatic alu gun, 3 m, 25 mm<sup>2</sup>

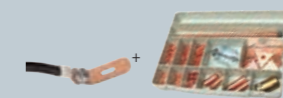

Earth cable  
2 m, 70 mm<sup>2</sup>

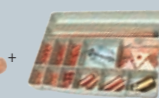

SPOTTER BOX PRO (050075)  
(Details p.10)

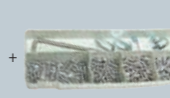

ALU BOX STANDARD (050020)  
(Details p.11)

				$I_2$ max	$U_2$	$I_{AM}$	RMS	kW			MANUAL	SYNERGIC			AUTOMATIC	MANUAL	SEPARATE CABLE GUN			LxWxH cm / kg
MADE IN GYS CHINA	62135	50/60 Hz		A	V	A	A		OK	OK	MANUAL	■	■	■	x1	—	—	3 m	Included Alu box	27 x 20.5 x 27 / 13.5
MADE IN FRANCE	GYSPOT ALU PRO FV	110 · 230V	6 m	13 000	50 · 200	5	—	0.65	OK	OK	■	■	■	■	x1	—	—	3 m	Included Alu box	49 x 38 x 29 / 13.4
	GYSPOT COMBI 230 E.PRO	230V	8 m	3800 (steel) 13000 (alu)	7,4 (steel) 50 · 200 (alu)	16	2800 (steel)	20	OK	OK	—	■	■	■	x1	x1	■	2/3 m	Included Spotter box + Alu box	54 x 76 x 34 / 47.5

GYSPOT

ALU + STEEL DENT PULLING



STEEL / ACIER / STAHL

**DENT BOX**  
CONSUMABLES / BAR / EASY

**SPOTTER BOX**  
STANDARD / 2600 / 2700

**SPOTTER BOX PRO**

Star - Étoile - Ausbeulstern	Ring - Rondelle - Unterlegscheiben	Tempering - Rétreinte - Temperieren	Impact shrinking & Lock nut - Rabattage d'impact & Écrou - Glätten	Wavy wire - Fil ondulé - Wellendraht
hexagon Earth plate small	chuck for inertia hammer copper coating star	carbon heating electrode	electrode warming point ø16 Ball electrode warming point ø16 M8	elec-trode wavy wire magnetic positioner
x1	x20	x5	x1	x1
049482	052239	049468	049567	049789
			059726	049727
			050303	049772

for spot welding machine only

Rings - Anneaux - Zugösen	Studs - Goujons - Gewindebolzen	Rivets - Rivets - Nieten	Nails - Clous	Stitch welding - Molette
elec-trode straight rings twisted rings lifting rod	electrode for threaded studs rivets ø5 - M5, M6 threaded M5 x 18 x 0.8 self-threading ø5 x 18 ø5 x 12	electrode ø16,3 x 4,50 ø3 x 3.25 ø3 x 4.50	electrode ø2 - M4 ø2	electrode wheel ø16 <small>for spot welding machine only</small>
x1	x1	x1	x1	x1
050655	049598	049604	049277	050310
050648	049383	049345	041561	049673
050631	049420	049352		052529
	050792	049413		049666
				051997

Rubber pad 062399

Steel gun earth adapter Ø 25 mm

DENT BOX

BEST SELLER

<b>CONSUMABLES</b> 051515	x20
<b>BAR</b> 050037	ideal PROLINER
<b>EASY</b> 053632	included EASYLINER

x1	x1	x1	x20	x1	x50	x1	x1	x1	x1	x25	x1	x25	x1	x25	x1	x50	x25

x1 180mm

x1 180mm

x1 x50 x50 x50

x1 x100 x100

SPOTTER BOX

<b>PRO</b> 050075	included PRO, EXPERT & COMBI 230	x1	x1	x1	x20	x1	x50	x1	x1	x1
<b>STANDARD</b> 053915		x1	x1	x1	x20	x1	x50	x1	x1	x1
<b>2600</b> 052277	ideal GYSPT 2600				x20	x1	x50	x1		
<b>2700</b> 053922	ideal GYSPT 2700				x20	x1	x50	x1	x1	

ELECTRODE FOR MAGNETIC EARTH (x1) 050013

SINGLE HOOK (x1) 051218

THREADED ROD FOR MAGNETIC EARTH (x5) 055438

Curved lifting rod 280 mm 064706

**Steel Ring sharpener**  
- Affuteur d'anneaux acier  
- Stahl ZugöSENSCHNEIDER

072565

Acier - Steel - Stahl

072299 Pneumatic punch and die sharpener for steel rings  
Poinçon et matrice affuteur pneumatique pour anneaux acier

SLIDE HAMMERS - Marteaux inertie - Ausbeulhammer

**COMPLETE**  
057272

1.1 kg

included (x1)  
included (x20)

Options

(x1) 054028

(x5) 050839

**COMPLETE KIT**  
051225

2.5 kg

(x1) (x25)

(x50) (x1) (x1)

Pulling handle 3 claws  
- Poignée de tirage 3 dents  
- Handzugkralle 3-fach

057326

057302

Pulling handle with hook  
- Poignée de tirage avec crochet

057319

Nails - Clous - Nägel  
041813

1.1 kg

Ø 2, M4 (x1) 049277

Ø 2 (x100) 041561

MIG/MAG nozzle for Nail welding 041523

Washers - Rondelles - Ringe  
051201

1.7 kg

51 cm

Ø 16, 8x16 (x1) 049574

8x16 (x100) 049444

(x1) 051218

Slide hammer kit - Kit marteau à inertie - Ausbeulhammerset  
051928

6 kg

ALU

Joint rings for mandrel Ø 4/5/6  
x2  
060814

ALU BOX LIGHT Ø4 / STANDARD Ø4 / Ø5 & 6

mandrel for ALU GUN				alu magnesium screws 12 mm				alu silicon screws 12 mm				screwable rings	fast pulling rings	lifting rod
ø4 x2	ø5 x1	ø6 x1	ø4 - M4 x200	ø4 - M4 x1000	ø5 x100	ø6 x100	ø4 - M4 x200	ø4 - M4 x1000	ø5 x100	ø6 x100	ø4 x5	ø5 x5	x3 : 180, 300, 500 mm	
049000	048157	048164	050273	050129	048140	048133	050280	050136	048126	048003	050297	058712	050792	

**ALU BOX**

<b>LIGHT Ø 4</b> 051522	ø4	ø4	
<b>STANDARD Ø 4</b> 050020	ø4	ø4	x5
<b>Ø 5 &amp; 6</b> 048195	x1	x1	x5
		ø5 x100 + ø6 x100	ø5 x100 + ø6 x100



# DENT PULLING DRAWN ARC ALU + STEEL

ACIER - STAHL



MANUAL

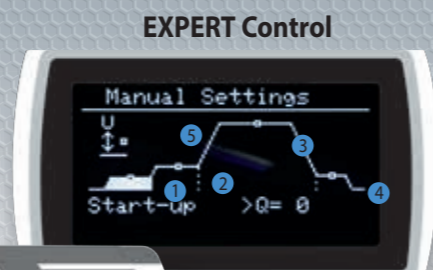

- Rings - Anneaux - Zugösen
- Studs - Goujons - Gewindebolzen
- Stainless steel nails - Tiges inox - Edelstahlnägel



- Start-up - Amorce - Zündung
- Scouring (I & t) - Décapage - Abbeizen
- Arc (I & t) - Arc - Lichtbogen
- Hitching (I & t) - Accroche - Verklebung
- Height - Hauteur - Höhe

7 languages  
FR, EN, DE, SP, IT, NL & RU

## SYNERGIC DIGITAL GUNS

★★★★★  
**UNIQUE Linear Motor**

**DRAWN ARC PROCESS**  
Gas protection

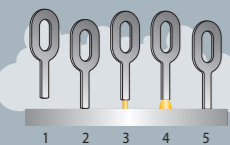

3 m, Ø 25 mm<sup>2</sup>  
included  
ARCPULL 200 & 350,  
COMBI ARCPULL



Full control



Consumables for Gun



FV FLEXIBLE VOLTAGE

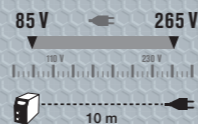

SR SECONDARY REGULATION



AD ANTI-DUST

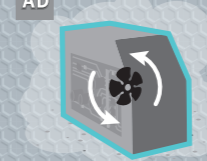

MANUAL & SYNERGIC CONTROL

2 GUNS INCLUDED



Ø max  
Alu : 6 mm  
Fe : 6 mm



GUN WITH CONNECTOR

### GYSPOT ARCPULL 200 CAR BODY REPAIR

100 · 230V · 1~  
**200 A** **T x1 MANUAL**  
FV SR AD  
057470  
included

- Manual synergic gun 3 m, 25 mm<sup>2</sup> (x1) 059610
- ALU RING BOX 1.5 mm (AlSpec + AlMg3 + AlMgSi) 059429
- Lifting rod 180 mm (x1) 082915

### OPTIONS

Weld 810 for ARCPULL 200 037489

### GYSPOT COMBI ARCPULL

230V · 1~  
**ARCPULL 200 A** + **EXPERT 3800 A**  
Alu + Acier / Steel / Stahl  
**T x1 MANUAL** + **T x1 MANUAL**

069824

Arccpull accessories included

- Manual synergic gun 3 m, 25 mm<sup>2</sup> (x1) 059610
- ALU RING BOX 1.5 mm (AlSpec + AlMg3 + AlMgSi) 059429
- Lifting rod 180 mm (x1) 082915

Expert accessories included

- Manual quick gun, 2 m, 70 mm<sup>2</sup> (057524) + Hammer (057272)
- Earth cable, 2 m, 70 mm<sup>2</sup>
- SPOTTER BOX PRO (050075) (Details p.10)

MADE IN FRANCE 60974-1	50/60 Hz	I <sub>2</sub> A	SYNERGIC	MANUAL	IRMS (A)	GUN		U <sub>2</sub> V	A	kW	OK	OK	LxWxH cm / kg
						Acier/Steel	Alu						
<b>GYSPOT ARCPULL 200 CAR BODY REPAIR</b>	110 · 230V	6 m	10 · 100 (110 V) 10 · 200 (230 V)	■	■	—	Manual + Digital Gun Motion Control	20.4 · 24 V (110 V) 20.4 · 28 V (230 V)	16	2.4 (110 V) 5.6 (230 V)	OK	OK	49 x 37 x 30 / 14.5
<b>GYSPOT COMBI ARCPULL</b>	230V	8 m	Alu 10 · 200 Acier 3800	■	■	Steel 3800	Manual Automatic (not included)	Alu 20.4 · 28 V Steel 7.4 V	16	Alu 5.6 Steel 20	OK	OK	72 x 42 x 29 / 41.5



GYS POT ARCPULL

# DENT PULLING DRAWN ARC ALU + STEEL ACIER - STAHL

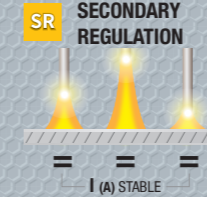
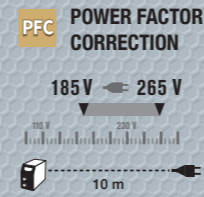

- Rings - Anneaux - Zugösen
- Start-up - Amorce - Zündung
- Hitching (I & t)
- Studs - Goujons - Gewindebolzen
- Scouring (I & t) - Décapage
- Accroche - Verklebung
- Stainless steel nails - Tiges inox
- Abbeizen
- Height - Hauteur
- Edelstahlnägel
- Abbeizen
- Arc (I & t) - Arc - Lichtbogen
- Hohe



**7**  
languages  
FR, EN, DE, SP, IT,  
NL & RU



∅ max  
Alu/Fe: **8 mm**



∅ max  
Alu: **10 mm**  
Fe: **13 mm**



## SYNERGIC DIGITAL GUNS

★★★★★ **DRAWN ARC PROCESS**  
Gas protection

**UNIQUE Linear Motor**

3 m, ∅ 25 mm<sup>2</sup>

included  
ARCPULL  
200, 350 &  
COMBI ARCPULL

Adjustable

**FULL CONTROL**

Consumables for Gun

- x2 059627
- x1 059610

### GYS POT ARCPULL 350 CAR BODY REPAIR

208 · 240V · 1~

**350 A** x1 MANUAL

PFC SR AD

082953

included

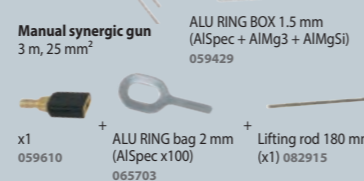
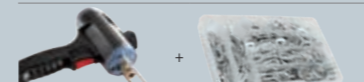

#### OPTIONS

Weld 810  
for ARCPULL 350  
037489

### GYS POT ARCPULL 700 CAR BODY REPAIR

380 · 480V · 3~

**680 A** x1 MANUAL

SR IP 23

#### OPTIONS

Weld 910  
for ARCPULL 700  
070967

details p.24

### 068315

included



MADE IN FRANCE 60974-1	50/60 Hz	6 m	I <sub>2</sub> A	SYNERGIC	TECHNOLOGY		U <sub>2</sub> V	+AM- A	kW	OK	OK	LxWxH cm / kg
					Acier/Steel	Alu						
GYS POT ARCPULL 350 CAR BODY REPAIR	208 · 240V	6 m	10 · 350	■	Manual + Digital Gun Motion Control	■	20.4 · 34V	16	11.9	OK	OK	48 x 36 x 30 / 17.4
GYS POT ARCPULL 700 CAR BODY REPAIR	3x 400V 3x 480V	5 m	50 · 680	■	Manual + Digital Gun Motion Control	—	22 · 44V	20 A (D) 16 A (D)	47.8 kW 45.7 kW	OK	OK	60 x 43 x 46 / 27.8







# GYS POT ARC PULL 200, 350 & COMBI ACCESSORIES & CONSUMABLES

## ACIER / STEEL / STAHL

x1 059634	x1 059641		x1 064065	x100 041561	x100 064034	x2 049000	x100 059603	x100 064607	x1 048157	x100 049383	x100 049413	x100 049420	x1 048164	x100 063969	x200 063990	x1 064041	x200 064003	x1 064058	x100 063976
<b>STEEL STUDS BOX 200 &amp; 350</b> 059443	x1	x1				x1	x100		x1	x100	x100	x100							x1

## ALU

x1 059634	x1 059641		x2 049000	x100 059573	x1 048157	x100 059580	x1 048164	x100 059597	x200 064010	x1 064041	x200 064027	x1 064058	x100 063983
<b>ALU STUDS BOX 200 &amp; 350</b> 059436	x1	x1	x1	x100	x1	x100	x1	x100		x1	x100		

	straight rings						twisted rings						
	Al-Special		AIMg3		AIMgSi		Al-Special		AIMg3 - x 50		AIMgSi - x 50		
box	n°1 1mm	n°4 1.5mm	n°8 2mm	n°2 1mm	n°5 1.5mm	n°3 1mm	n°6 1.5mm	n°1 1mm	n°4 1.5mm	n°2 1mm	n°5 1.5mm	n°3 1mm	n°6 1.5mm
	x100	x100	x100	x100	x100	x100	x100	x50	x50	x50	x50	x50	x50
	059535	059559	065703	059498	059511	059450	059474	059542	059566	059504	059528	059467	059481
box	<b>ALU RING BOX 1 mm</b> 059412												
	1mm x 50		1mm x 50		1mm x 50		1mm x 20		1mm x 20		1mm x 20		
box	<b>ALU RING BOX 1.5 mm</b> 059429												
	1.5mm x 50		1.5mm x 50		1.5mm x 50		1.5mm x 20		1.5mm x 20		1.5mm x 20		
sachet - bag	<b>ALU RING BOX 2 mm</b> 065703												
	2mm x 100												

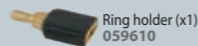

Earth clamp  
Croco T400.70  
043787



Double earth clamp  
25 mm², 3 m, 350 A  
070714

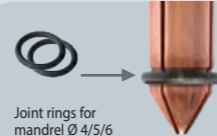

Joint rings for  
mandrel Ø 4/5/6  
x 2  
060814

		x1 059634	x1 059641	x1 064065	x2 049000	x1 048157	x1 048164	x1 064041	x1 064058	x1 070806	x1 070790	x1 070752	x1 070769	x1 070776	x1 070783	x1 070714
<b>STUDS HOLDER BOX 350</b> 064591		x1	x1	x1	x1	x1	x1	x1	x1							x1
<b>ARCPULL DIFFICULT ACCESS BOX 350</b> 070813		x1	x1							x1	x1	x1	x1	x1	x1	x1

Difficult access :

To be used with :

x100 064607		x1 059634	x1 059641	x2 049000	x1 064683	x1 067721	x1 070738	x100 070745	x1 066151	
<b>ARCPULL RIVET BOX 1 350 - 24kN</b> 064584		x100	x1	x1	x1	x1	x1			
<b>ARCPULL RIVET BOX 2 350 - 50 kN</b> 073388			x1	x1				x1	x100	x1



## GYS POT ARC PULL 700 - ACCESSORIES & CONSUMABLES

x100 070745	x1 070738	x1 066151	x1 071377	x1 059641	x2 059610	x1 071384	x1				
<b>ARCPULL RIVET BOX 700</b> 068452	x100	x1		x1	x1	x2	x1	x1	x1	x1	

Gas protection (x1)	068346
Ground studs holders	
Ø 6	x1 075368
Ø 8	x1 075375
Ø 10	x1 075382
Threaded holders	
Ø 5	x1 076174
Ø 6	x1 068391
Ø 8	x1 068407



# FAST DENT PULLING

## STEEL / ACIER / STAHL

### EASY TOOL CONNECTION



for GYSPOT 39.02/04, PRO 230/400, EXPERT 230/400, COMBISPOT 230



051690

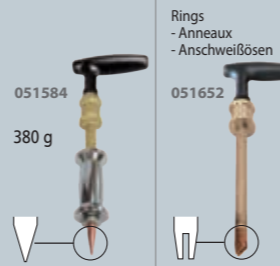

051584  
380 g

051652

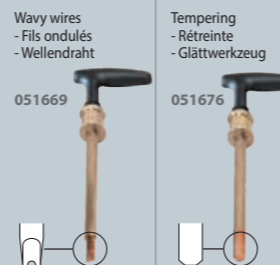

051669

051676



Manual dent-pulling bar - Poignée de tirage manuel  
057289



EASYGUN  
051317

Box of 3 electrodes for accessories  
050822



### MANUSPOT =

050679



Tools set and support for DENT 600, 800, 1000, 1600, Workstation & Dentstation



EASYGUN  
051317



MANULINER  
050471

3 m  
Ø 35 mm2

PATENTS REGISTERED NUMBERS  
001652108-0003  
EUROPEAN TRADEMARK & DESIGN

4 positions  
4 Positionen

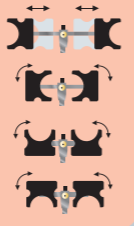

### FAST & EASY



RINGMATIC  
052154

included  
(x 50)



Option  
Gun adapter  
- Adaptateur  
pistolet  
052499

### MANULINER/GUN

056831

PATENTS REGISTERED NUMBERS  
001652108-0003  
EUROPEAN TRADEMARK & DESIGN

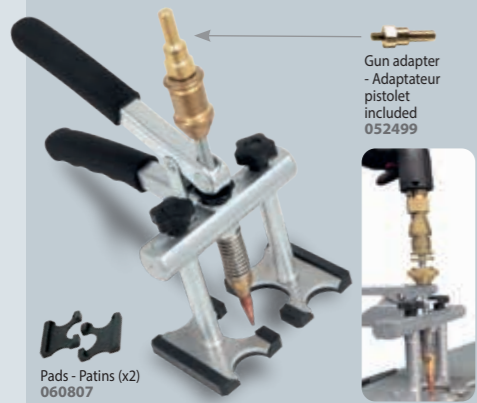

Pads - Patins (x2)  
060807

Gun adapter  
- Adaptateur  
pistolet  
included  
052499

### DENT AXE PULLER

080508

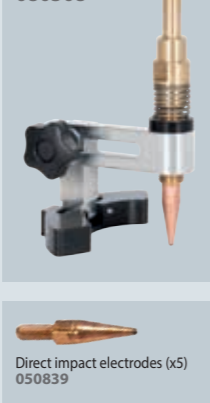

Direct impact electrodes (x5)  
050839

### QUICK SPOT AIR GUN V2

057340



LIGHT  
920 g

AIR

QUICK SPOT AIR GUN V2  
+ Mini-fraiseuse - Mini-Druckluftfräser  
065567



057340 + 063228  
Included  
Tungsten drill  
Ø 6 mm  
054172

Gun adapter  
- Adaptateur  
pistolet  
052826

### MANU PULLER

079502



Included  
Alu 3  
065178

Included  
Steel  
079830

Included  
Alu 4  
065185



## ALU

### ARC PULLER PREMIUM

065161



Included  
Alu 3  
065178

Included  
Alu 4  
065185

Pads - Patins  
(x2)  
069008

ULTRA RESISTANT  
No deformation

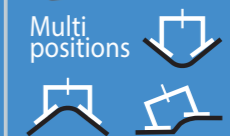

### ARC PULLER PREMIUM PRO

072572



Pads - Patins  
(x4)  
074958

Included  
Alu 3  
065178

Included  
Alu 4  
065185

## ALU PULLER

051003

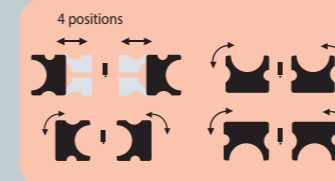

4 positions



Included  
Alu 1  
050938

Included  
Alu 2  
050945

Patins - Pads (x2)  
060807

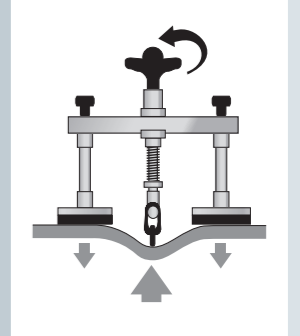

### STRAIGHT LINE LAMP

- Lampe ligne droite - Dentline-laser

056770



### FAST PULLING RINGS

- Anneaux de tirage rapide

058743



x5  
058712

Alu 1  
050938

Alu 2  
050945

goujons alu - alu screws  
Ø 4, 5 & 6 mm

### ALU HAMMERS

- Marteaux alu

020986



Marteau à inertie 380 g  
050051

Heat gun  
- Décapeur thermique  
- Heißluftpistole

I: 100/300°C (450 W)  
II: 300/650°C (1500 W)  
Air flow: 450 l/min

230 V only



066311

Gas hot air gun - Pistolet à air chaud autonome à gaz

Bouteille de gaz incluse, gas cylinder included



060777

Blow torch - Lampe à souder - Lötlampe

NOVACET



052741

Novacet+ (Butane/propane/propylene) 380 ml/220 g

HIGH QUALITY



040441

Brushes - Brosses - Bürsten - Brosses - Cepillos

Inox - Stainless - Edelstahl



044258

Thermal marking pencil - Crayon marqueur thermique

121°C / 250°F



052765

Freezer spray - Spray refroidisseur

-50°C  
400 ml

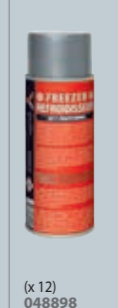

(x 12)  
048898

Heat barrier spray - Spray barrière thermique

054325



Infrared Thermometer - Thermomètre infrarouge

-50 / +600°C  
-58 / +1112°F

Adjustable emissivity: 0.10 ~ 1.00



079922

NEW

# PULLING BARS

## 3 PRODUCT LINES

### 1 STANDARD

### 2 PREMIUM



### 3 PREMIUM PRO



## STANDARD

**Levelling lever**  
- Levier de débosselage  
- Zughebel

**050686**  
↓ 1.6 kg  
⊗ 79 x 12 x 17 cm / 1.9 kg

PATENTS REGISTERED NUMBERS  
001652108-0002  
EUROPEAN TRADEMARK & DESIGN

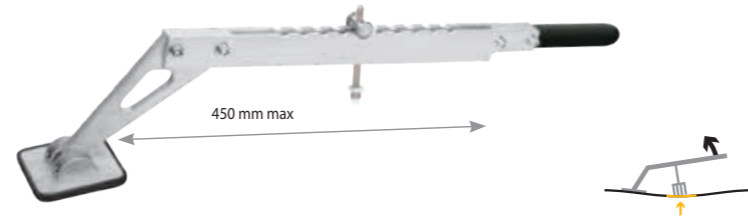

**Double action levelling bar**  
- Barre de débosselage double action  
- Zughebelbrücke

**053564**  
↓ 2.5 kg  
⊗ 77 x 12 x 13 cm / 3.2 kg

Licensed by  
BETAG.Innovation

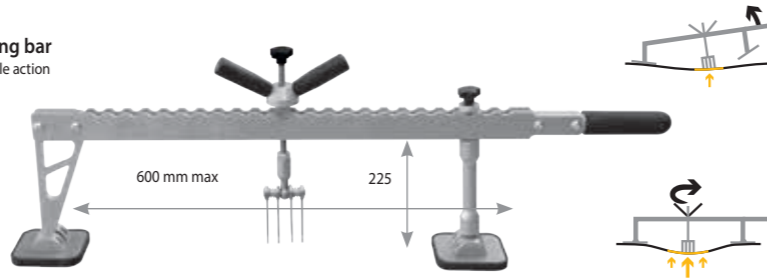

**Levelling bar**  
- Barre de débosselage  
- Zugbrücke

**050693**  
↓ 3.4 kg  
⊗ 87 x 17 x 19 cm / 4 kg

Licensed by  
BETAG.Innovation

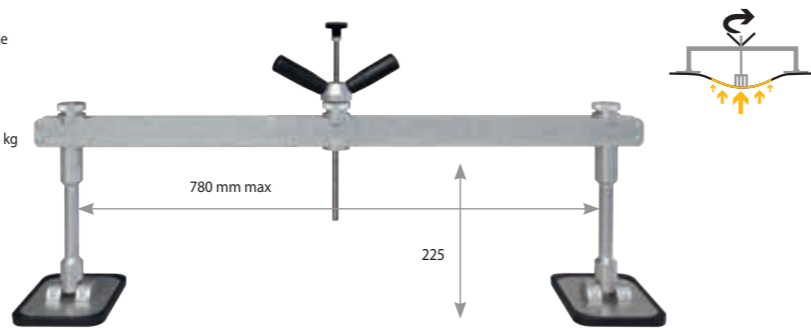

**Reinforced scissoring bar**  
- Barre de tirage renforcée  
- Scherenzugbrücke

**050716**  
↓ 5.1 kg  
⊗ 87 x 17 x 18 cm / 5.9 kg

PATENTS REGISTERED NUMBERS  
001652108-0001  
EUROPEAN TRADEMARK & DESIGN

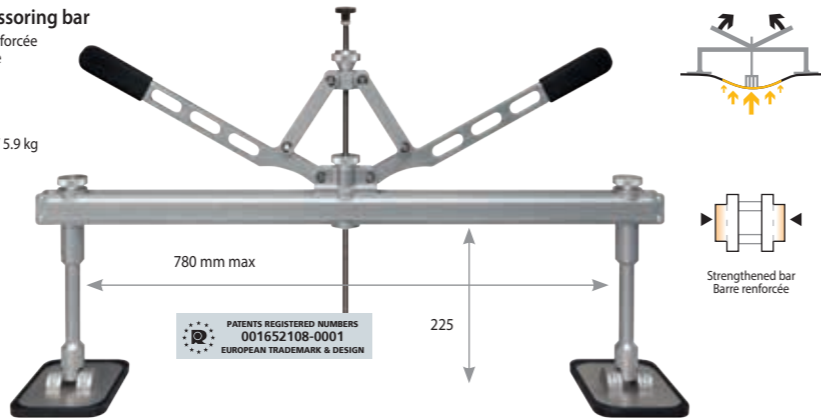

## SLIDE & LOCK

Removable system : pads and pulling systems  
Système amovible : patins et chariots de tirage

FEET



PULLING SYSTEM  
only for 059313



## LIGHTWEIGHT

Léger



GRIP 360

360° pads with grip  
Patins à frein orientables à 360°



X-CROSS

Possibility of crossing the bars  
Possibilité de croiser les barres

## PREMIUM

**Premium levelling lever**  
- Levier de débosselage Premium  
- Premium Zughebel

**059290**  
↓ 1.6 kg  
⊗ 100 x 16 x 17 cm / 2.2 kg

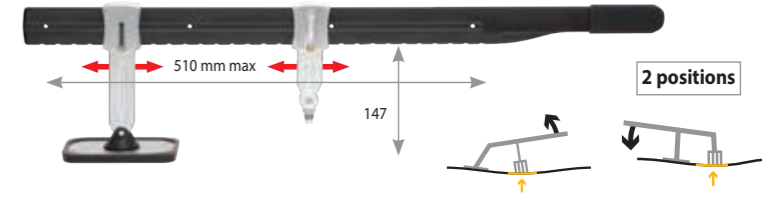

**Premium levelling bar**  
- Barre de débosselage Premium  
- Premium Zugbrücke

**059306**  
↓ 2.8 kg  
⊗ 79 x 30 x 13 cm / 3.2 kg

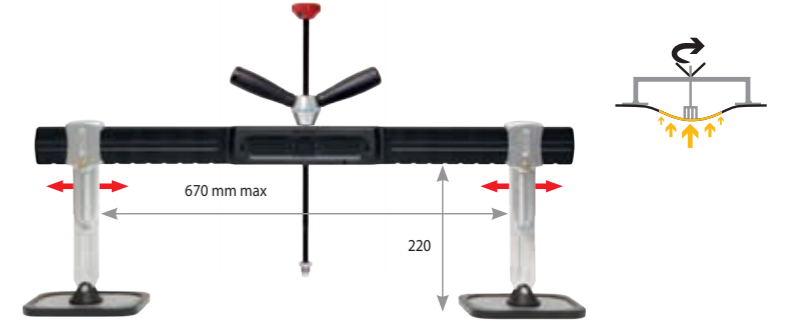

**Premium scissoring bar**  
- Barre de tirage Premium  
- Premium Scherenzugbrücke

**058996**  
↓ 3.1 kg  
⊗ 87 x 16 x 18 cm / 3.9 kg

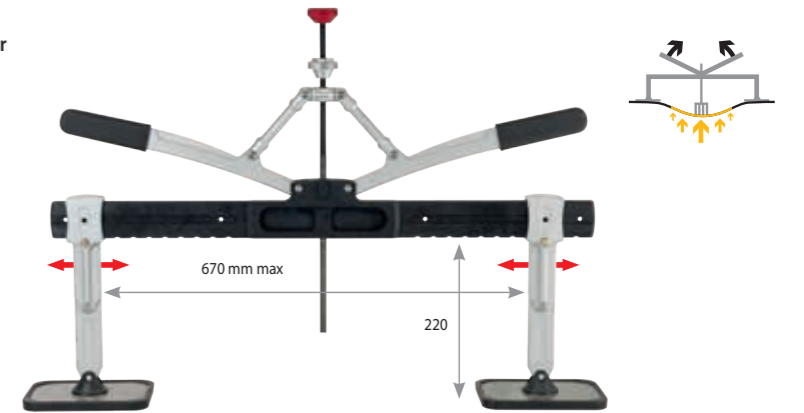

**Premium 1200 scissoring bar**  
- Barre de tirage 1200 renforcée Premium  
- Premium Scherenzugbrücke 1200

**059313**  
↓ 5.6 kg  
⊗ 127 x 26 x 9 cm / 6.2 kg

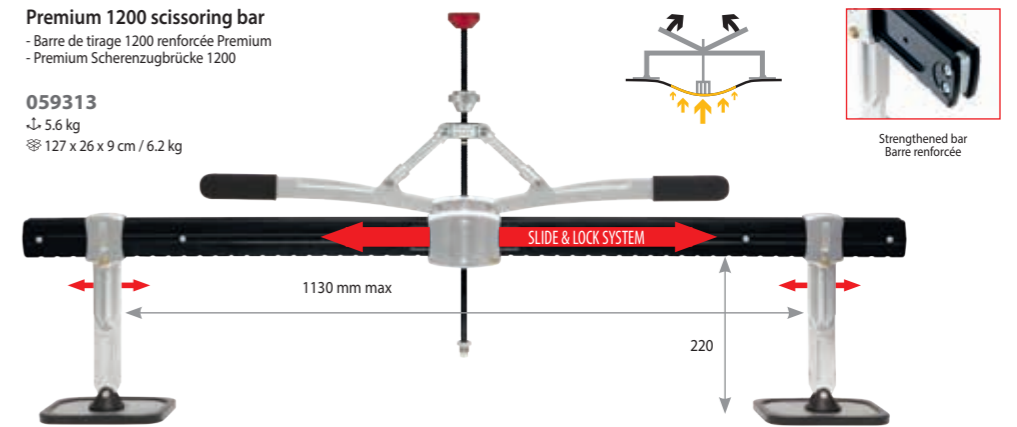

## OPTIONS

**Reinforced bar 1200 mm - Barre renforcée**  
051171

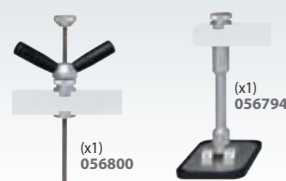
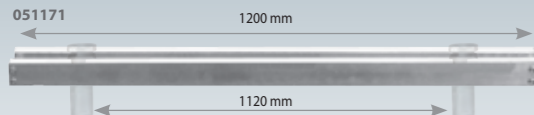

Fixing screw  
058439

**Double pads support**  
- Support double patin  
- Doppelfüße  
050723

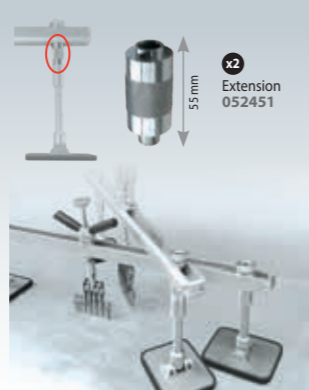

STANDARD



**2 teeth hook**  
Ø M10  
057296

STANDARD

PREMIUM (LONG FEET NEEDED)



**4 tooth claw**  
Ø M10 / M14  
049758



**6 tooth claw**  
Ø M10 / M14  
049734

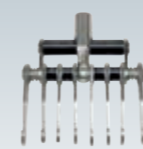

**8 tooth claw**  
Ø M10 / M14  
049741



**Ring-Pulling**  
068995

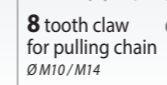

**8 tooth claw for pulling chain**  
Ø M10 / M14  
067745

PREMIUM



**2 teeth hook PREMIUM**  
Ø M14  
059382



**3 teeth hook PREMIUM**  
Ø M14  
059658



x1 059320



x2 059351

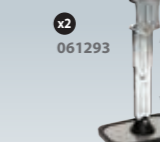

x2 061293



x2 059375

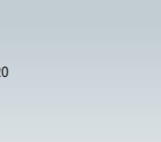

x1 072688



x1 059399

## OPTIONS



069268



059399

# ★★★ SUPER ERGONOMIC

BREVET GYS PATENT PENDING GYS PATENT



## QUICK HOOK

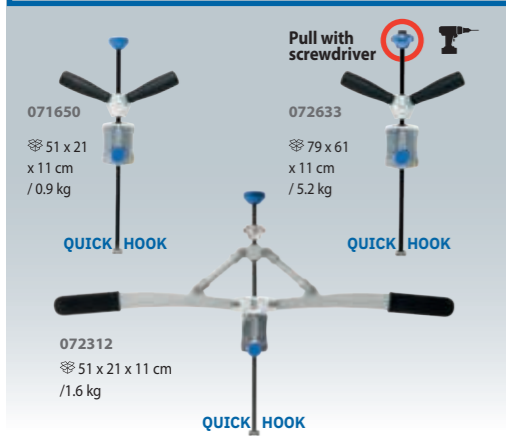
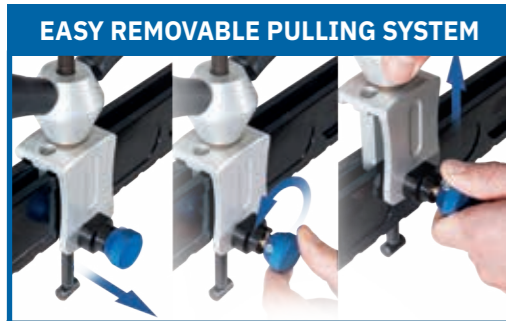
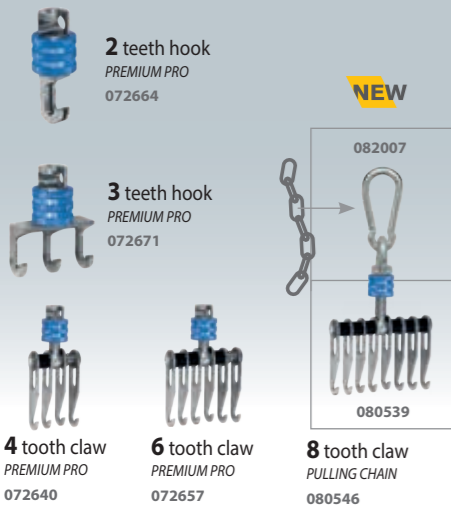

# PREMIUM PRO

**Premium Pro Levelling lever**  
- Levier de débosselage Premium Pro  
- Premium Pro Zughebel

072619  
↳ 1.6 kg  
⊗ 87 x 17 x 18 cm / 2.3 kg

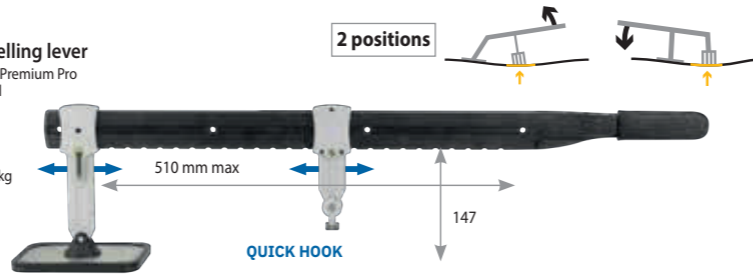

**Premium Pro Levelling bar 900mm / Single feet**  
- Barre de débosselage Premium Pro 900 mm  
- Premium Pro Zugbrücke 900 mm

071643  
⊗ 120 x 26 x 8 cm / 4.4 kg  
↳ 3.8 kg

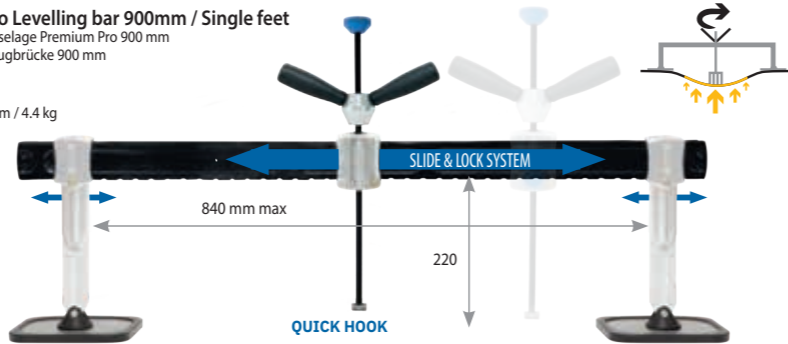

**Premium Pro Levelling bar 900mm / Double feet**  
- Barre de débosselage Premium Pro 900 mm  
- Premium Pro Zugbrücke 900 mm

080102  
↳ 3.8 kg

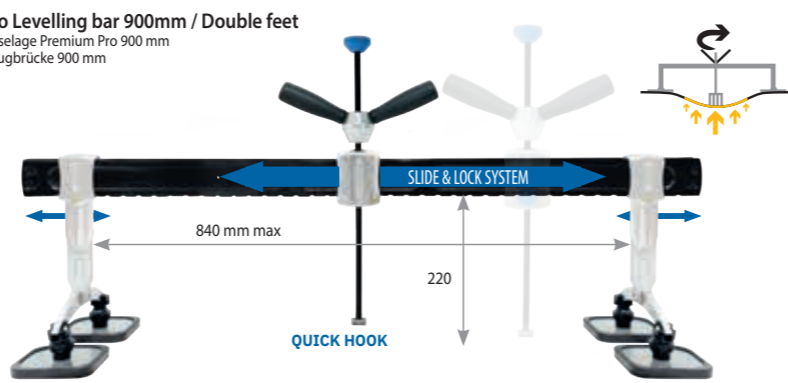

**Premium Pro Scissoring bar 900mm**  
- Barre de tirage Premium Pro 900 mm  
- Premium Pro Scherenzugbrücke 900 mm

072305  
⊗ 103 x 30 x 13 cm / 5.2 kg  
↳ 4.5 kg

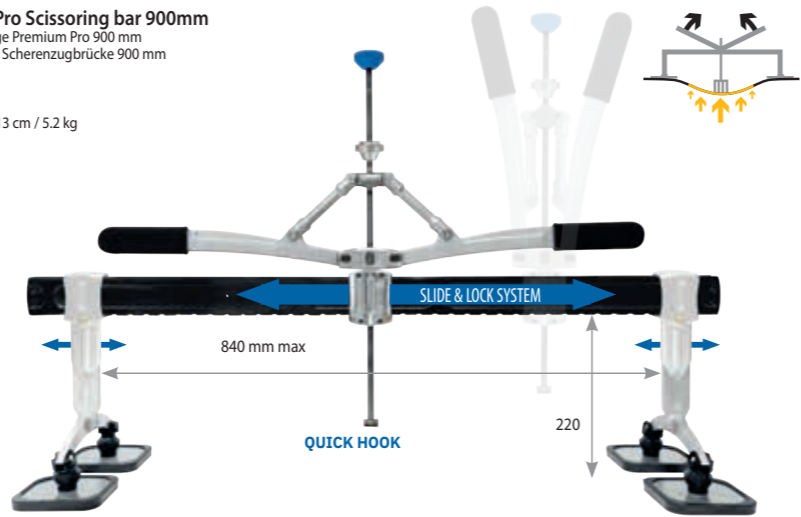

**Premium Pro Scissoring bar 1150 mm**  
- Barre de tirage Premium Pro 1150 mm  
- Premium Pro Scherenzugbrücke 1150 mm

072626  
⊗ 124 x 7 x 7 cm / 3.1 kg



## PREMIUM BAR SMARHAND

for Premium & Premium Pro  
072480





# DENT PULLING WORKSTATIONS

**A COMPLETE SOLUTION  
UNE SOLUTION COMPLÈTE  
KOMPLETTLÖSUNGEN**

## Compatibility

SPOT	Dent 600	Dent 1000	Universal 800	Weld 810	Weld 910	Dent 1600	Dent 1600 WD	Dentstation Pro WD
26/27.02	✓	✓	✓	✓		✓		✓
34.02/04	✓	✓	✓	✓		✓		✓
39.02/04	✓	✓	✓	✓		✓		✓
PRO 230/400	✓	✓	✓	✓		✓		✓
EXPERT 230/400	✓	✓	✓	✓		✓		✓
ALU 66	✓	✓	✓					✓
ALU PRO FV	✓	✓	✓					✓
COMBI 230 E.PRO						✓		✓
ARCPULL 200/350				✓	✓	✓		✓
COMBI ARCPULL						✓		✓
ARCPULL 700					✓	✓		✓

**Universal 800**  
↕ 60 x 48 x 83 cm  
17,6 kg  
↔ 79 x 39 x 18 cm  
18,1 kg  
051331

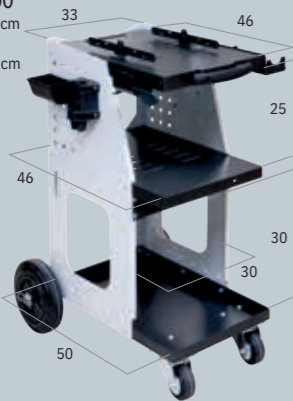

**Weld 810**  
↕ 77 x 50 x 84 cm  
20,1 kg  
↔ 80 x 51 x 14 cm  
21,6 kg  
037489

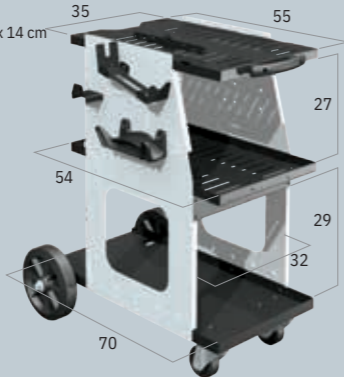

**Weld 910**  
↕ 89 x 52 x 84 cm  
25 kg  
↔ 80 x 52 x 22 cm  
27 kg  
070967

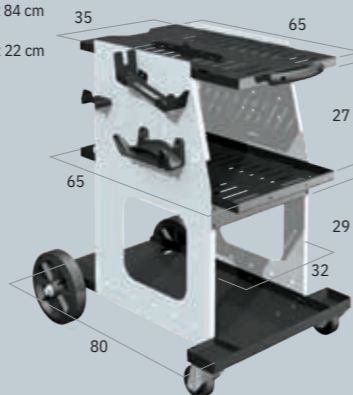

**Dent 1600**  
↕ 70 x 69 x 161 cm  
/ 35,8 kg  
↔ 103 x 66 x 22 cm  
/ 38,7 kg  
072596

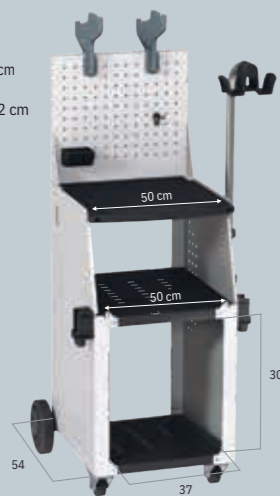

**Dent 1600 WD**  
↕ 71 x 70 x 161 cm  
/ 49,5 kg  
↔ 103 x 66 x 22 cm  
/ 52,4 kg  
072169

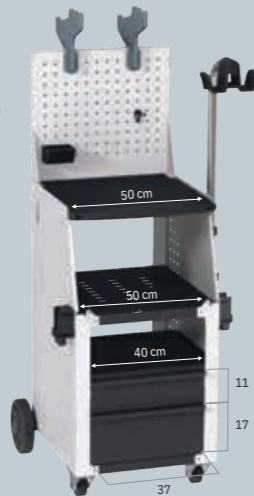

**Dentstation Pro WD**  
↕ 90 x 71 x 161 cm  
/ 65 kg  
↔ 120 x 80 x 28 cm  
/ 68,5 kg  
072800



## CHARIOTS / TROLLEYS

**Dent 600**  
↕ 44 x 35 x 62 cm / 6,9 kg  
↔ 60 x 39 x 14 cm / 7,4 kg  
072831

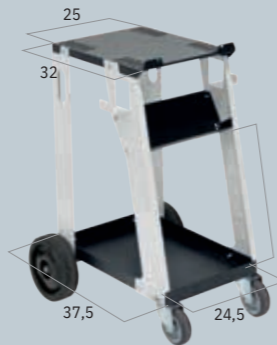

**Dent 1000**  
↕ 44 x 35 x 98 cm / 9,3 kg  
↔ 60 x 39 x 14 cm / 9,9 kg  
072848



4 m<sup>3</sup> support for Dent 1600 / 1600 WD & Dentstation Pro WD 059665

Cable support for Spot 800, 1600 & Dentstation Pro WD 052284

Protection cover - Housse de protection - Schutzhaube for Universal 800 062733 for Spot 1600 & Dent 1600 048881 for Dentstation Pro 059870

## EASYLINER



EASYLINER 39.02

EASYLINER PRO 230

## PROLINER



PROLINER 39.02  
PROLINER 39.04

PROLINER PRO 230  
PROLINER PRO 400

PROLINER ALU PRO FV

PROLINER ARCPULL 200

### STEEL / ACIER / STAHL



GYSPOT (guns & consumables included)

### STEEL / ACIER / STAHL



GYSPOT (guns & consumables included)

### ALU



GYSPOT (guns & consumables included)

39.02	PRO 230	39.02	PRO 230	ALU PRO FV	ARCPULL 200
053618 ☎ : 058521	072398	035775	035799	035836	065260



#### INCLUDED ACCESSORIES



DENT 1000 072848

Dent box easy 053632

#### INCLUDED ACCESSORIES



UNIVERSAL 800 051331 + Cable support 052284

Dent box easy 050037

#### INCLUDED ACCESSORIES



UNIVERSAL 800 051331 + Cable support 052284

#### INCLUDED ACCESSORIES



Weld 810 037489 + Cable support 052284



Levelling bar double action 053564

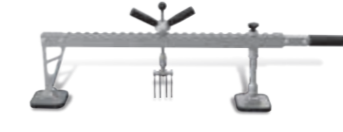

Levelling bar double action 053564



Alu puller 051003



Arc puller premium 065161

# SPEEDLINER STANDARD

\*\*\*  
COMPLETE  
SYSTEM



PRO 230, 400

EXPERT 200, 230, 400

COMBI 230 E.PRO

ARCPULL 200  
+ PRO 230, 400

ARCPULL 200  
+ EXPERT 200, 230, 400

ALU PRO FV

## STEEL / ACIER / STAHL



GYSPOT  
(guns & consumables included)



GYSPOT  
(guns & consumables included)



GYSPOT  
(guns & consumables included)



GYSPOT  
(guns & consumables included)

PRO 230 074446	EXPERT 200 074460	COMBI 230 E PRO 074491	ARCPULL 200 + PRO 230 074507	ARCPULL 200 + EXPERT 200 074521	ALU PRO FV 074552
PRO 400 074453	EXPERT 230 074477		ARCPULL 200 + PRO 400 074514	ARCPULL 200 + EXPERT 230 074538	
	EXPERT 400 074484			ARCPULL 200 + EXPERT 400 074545	

### INCLUDED ACCESSORIES

DENT 1600 072596	Cable support 052284	Levelling bar 850 mm 050693	
Magnetic earth 049666	Multihook heads 049758+049734	Levelling bar 050686	
Manuspot 050679	Dent box consumables 051515 3 lifting rods 050792	Ringmatic 052154	
Alu puller 051003	Cable support 052284	Arc puller premium 065161	Cable support 052284 + 4 m support 059665
Stainless steel brush 044258 Alu Box 05 & 6 048195	Infrared Thermometer 079922 Hot air gun 650°C 066311		

without generator (excluded Ringmatic) : 035058

# SPEEDLINER PREMIUM

★★★★  
COMPLETE SYSTEM



PRO 230, 400



EXPERT 200, 230, 400



COMBI 230 E.PRO



ARCPULL 200  
+ PRO 230, 400



ARCPULL 200  
+ EXPERT 200, 230, 400



ARCPULL 200, 350

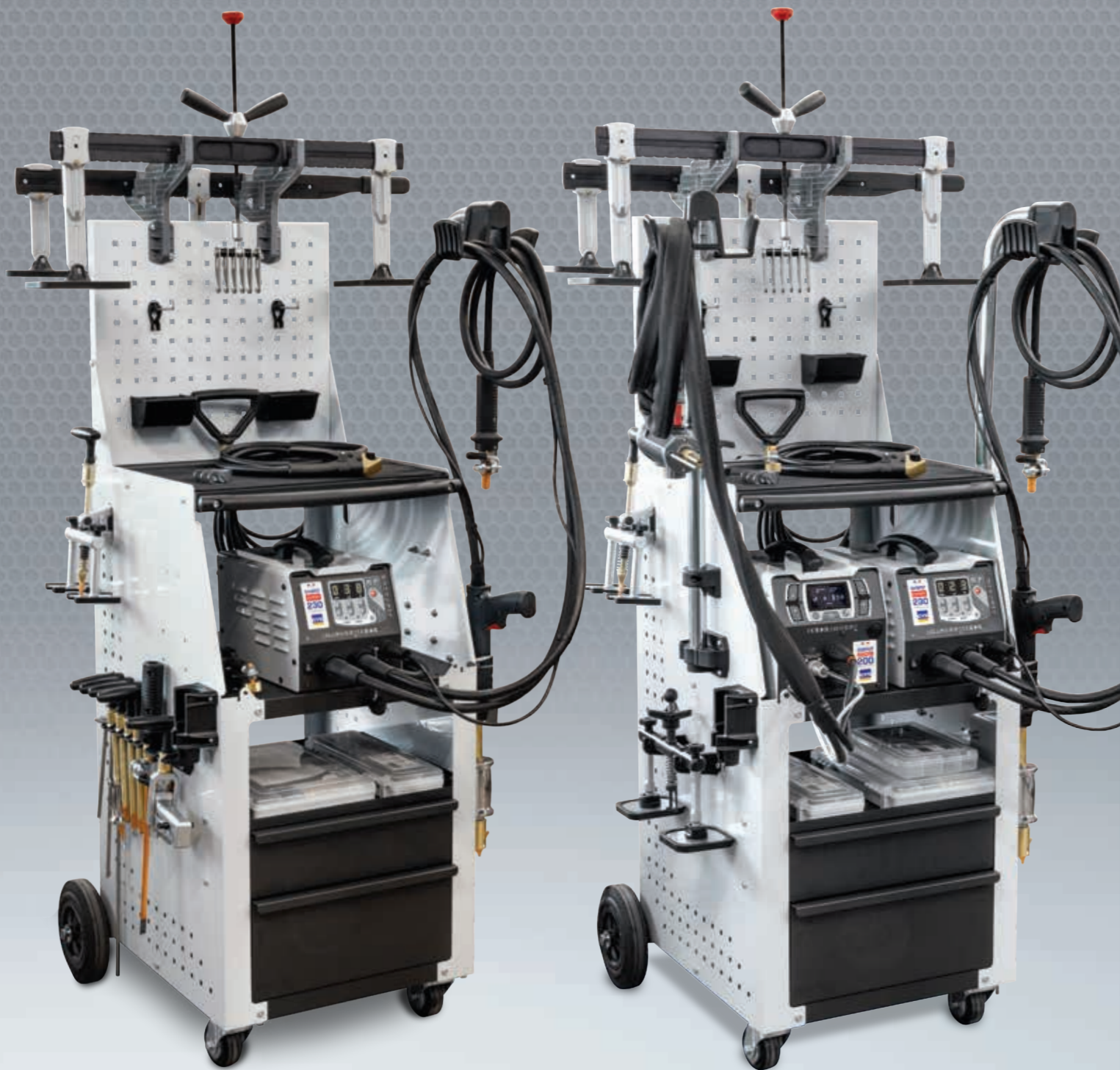

## STEEL / ACIER / STAHL



GYSPOT  
(guns & consumables included)



GYSPOT  
(guns & consumables included)



GYSPOT  
(guns & consumables included)

## ALU



GYSPOT  
(guns & consumables included)

PRO 230 073883	EXPERT 200 073906	COMBI 230 E PRO 073968	COMBI ARCPULL 074569	ARCPULL 200 + PRO 230 073975	ARCPULL 200 + EXPERT 200 073913	ARCPULL 200 073999	ARCPULL 350 083042
PRO 400 073890	EXPERT 230 073920			ARCPULL 200 + PRO 400 073982	ARCPULL 200 + EXPERT 230 073937	077317 (without HOT AIR GUN)	
	EXPERT 400 073944				ARCPULL 200 + EXPERT 400 073951		

### INCLUDED ACCESSORIES

DENT 1600 WD 072169	Cable support 052284	Premium levelling bar 720 mm 059306	
Hook head 049758 + 059658 + 059382	Premium levelling lever 059290		Dent box consumables 051515 + 3 lifting rods 050792
Magnetic earth 049666	Manuspot 050679	Manual pulling handle 057289 Ringmatic 052154	
Fast pulling rings (x5) 058712 + Alu puller 051003 + Cable support 052284		4 m³ support 059665 Arc puller premium 065161 + Cable support 052284	Arc puller premium 065161
Cable support 052284		4 m³ support 059665	Cable support 059665

### INCLUDED ACCESSORIES

DENT 1600 WD 072169 Cable support 052284	Alu Ring Box 1 mm 059412 Premium 2-teeth hook 059382
Arc puller premium 065161	Premium levelling bar 720 mm 059306
Alu hammers 020986	Infrared Thermometer 079922 Hot air gun 650°C 066311
Set of pencil punches with 6 teflon tips 052888	3 lifting rods 050792
Stainless steel brush 044258	4 m³ support 059665



# SPEEDLINER PREMIUM PRO



PRO 230, 400



EXPERT 200, 400  
+ ARCPULL 200, 350



COMBI ARCPULL



ARCPULL 200, 350

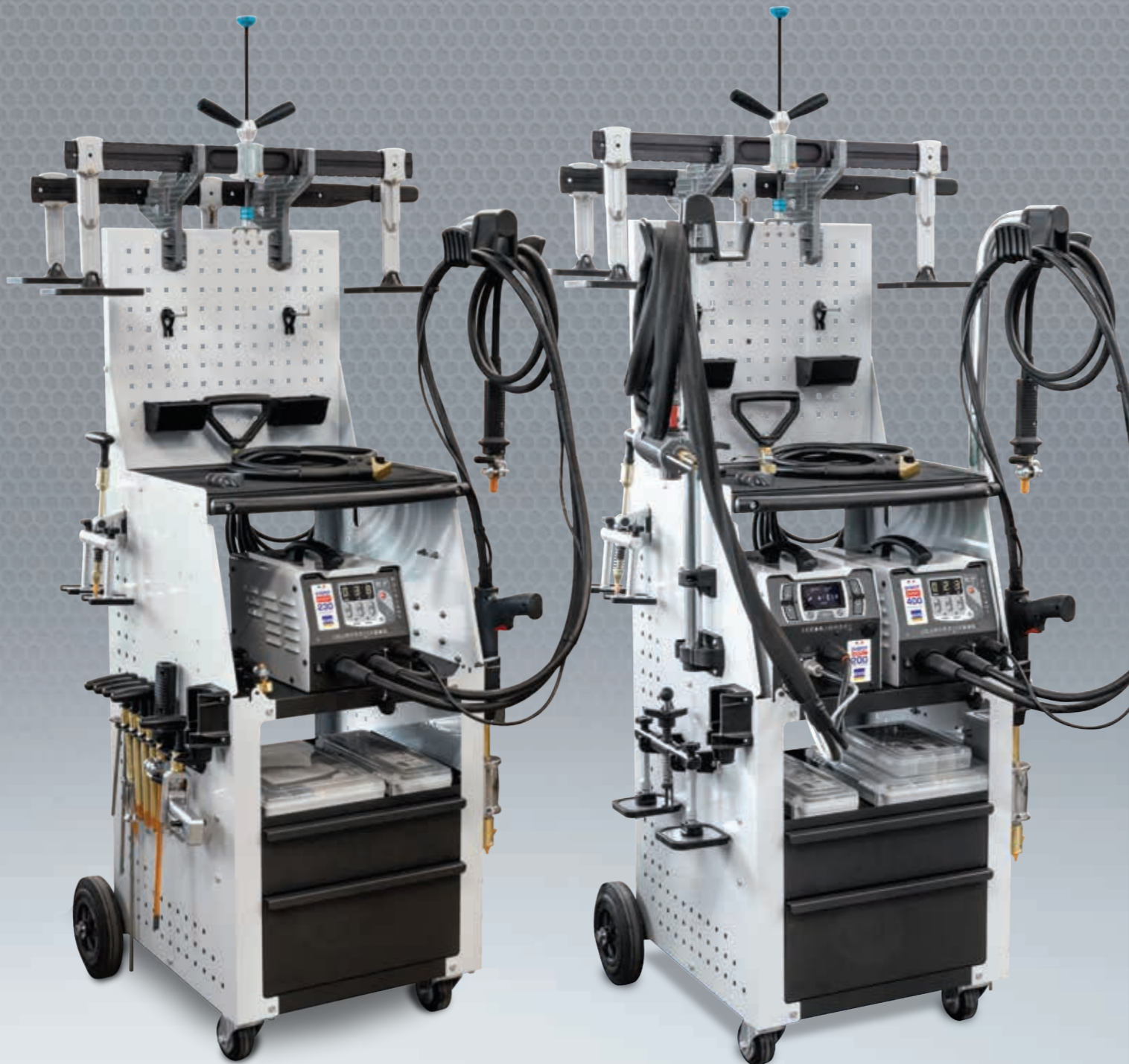

## STEEL / ACIER / STAHL



GYSPOT  
(guns & consumables included)

## ALU + STEEL / ACIER / STAHL



GYSPOT  
(guns & consumables included)

## ALU



GYSPOT  
(guns & consumables included)

EXPERT 230 080201	EXPERT 400 080218	EXPERT 400 + ARCPULL 200 080232	EXPERT 400 + ARCPULL 350 083028	COMBI ARCPULL 080225	ARCPULL 200 080256	ARCPULL 350 083035
		EXPERT 200 + ARCPULL 200 080553				

### INCLUDED ACCESSORIES

### INCLUDED ACCESSORIES



# DENTSTATION STANDARD



## STEEL / ACIER / STAHL



## ALU + STEEL / ACIER / STAHL



39.02	PRO 230	EXPERT 200	COMBI 230 E PRO	ARCPULL 200 + PRO 230	ARCPULL 200 + EXPERT 200
078161	078208	078321	078529	078222	078338
39.04	PRO 400	EXPERT 230		ARCPULL 200 + PRO 400	ARCPULL 200 + EXPERT 230
078185	078260	078369		078284	078384
		EXPERT 400			ARCPULL 200 + EXPERT 400
		078444			078468



### INCLUDED ACCESSORIES

<p>Dentstation Pro WD 072800 Fixing kit 051362</p>	<p>Double pads 050723</p>	<p>Levelling bar 850 mm 050693</p>	<p>Scissoring bar 050716</p>
<p>Magnetic earth 049666</p>	<p>Multihook heads 049758 +049734 +049741</p>	<p>Levelling lever 050686</p>	<p>Strengthened bar 1200 mm 051171 Extensions (x2) 052451</p>
<p>Fast pulling rings (x5) 058712 + Alu puller 051003</p>	<p>Manuspot 050679</p>	<p>Dent box consumables 051515 3 lifting rods 050792 Empty box 320x113mm</p>	<p>Manual pulling handle 057289</p>
<p>Cable support 052284</p>	<p>Arc puller premium 065161</p>	<p>Cable support 052284 + 4 m² support 059665 + Flanges (x 2) 062146</p>	

# DENTSTATION PREMIUM



PRO 230, 400



EXPERT 200, 230, 400



COMBI 230 E.PRO  
COMBI ARCPULL



ARCPULL 200  
+ PRO 230, 400



ARCPULL 200  
+ EXPERT 200, 230, 400

★ ★ ★ ★  
COMPLETE  
SYSTEM

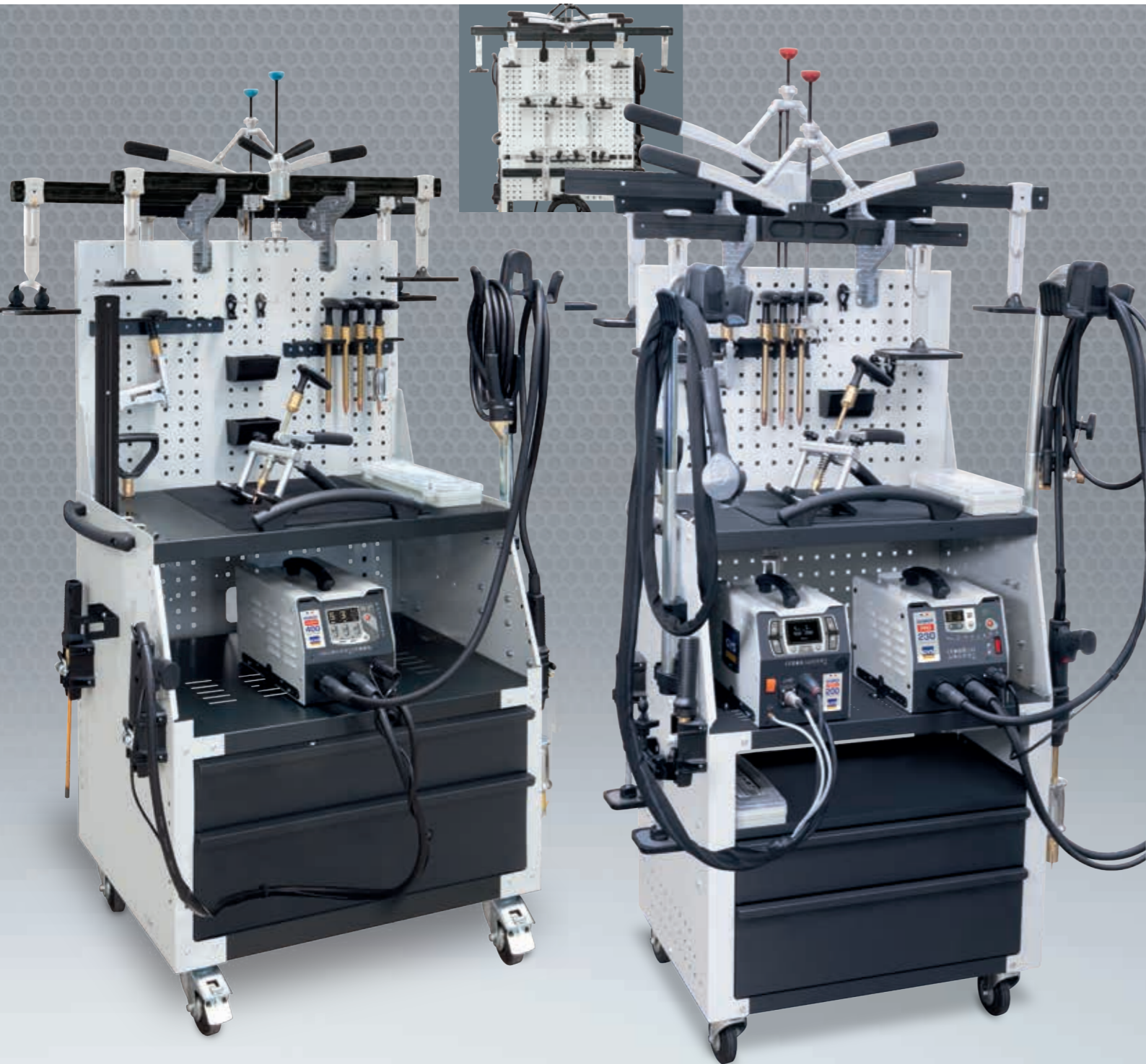

## STEEL / ACIER / STAHL



GYSPOT  
(guns & consumables included)

## ALU + STEEL / ACIER / STAHL



GYSPOT  
(guns & consumables included)



GYSPOT  
(guns & consumables included)

<b>PRO 230</b> 078239	<b>EXPERT 200</b> 078345	<b>COMBI 230 E PRO</b> 078543	<b>COMBI ARCPULL</b> 078567	<b>ARCPULL 200 + PRO 230</b> 078253	<b>ARCPULL 200 + EXPERT 200</b> 078352
<b>PRO 400</b> 078291	<b>EXPERT 230</b> 078406			<b>ARCPULL 200 + PRO 400</b> 078314	<b>ARCPULL 200 + EXPERT 230</b> 078420
	<b>EXPERT 400</b> 078482				<b>ARCPULL 200 + EXPERT 400</b> 078505

### INCLUDED ACCESSORIES

x6 x2	Manuspot 050679	Premium levelling bar 720 mm 059306	Premium levelling lever 059290
Dentstation Pro WD 072800 Fixing kit 051362	Hook head 049734 + 059658 + 059382	Premium scissoring bar 720 mm 058996	Premium scissoring bar 1200 mm 059313
Magnetic earth 049666	Premium double pads support 150 mm (x2) 059351 + 220 mm (x2) 059375	Dent box consumables 051515 3 lifting rods 050792 Empty box 320x113mm	Manual pulling handle 057289
		Ringmatic 052154	

Fast pulling rings (x5) 058712 Alu puller 051003 Cable support 052284	Cable support 052284 4 m support 059665 Flanges (x 2) 062146 Arc puller premium 065161	Arc puller premium 065161	Cable support 052284 4 m support 059665 Flanges (x 2) 062146
--	---	------------------------------	---

# DENTSTATION PREMIUM PRO



EXPERT 230, 400



COMBI ARCPULL



EXPERT 400  
+ ARCPULL 200, 350



ARCPULL 200, 350

## STEEL / ACIER / STAHL



1 BOX GYSPOT (guns & consumables included)

## ALU + STEEL / ACIER / STAHL



1 BOX GYSPOT (guns & consumables included)

## ALU



1 BOX GYSPOT (guns & consumables included)

EXPERT 230	EXPERT 400	EXPERT 400 + ARCPULL 200	EXPERT 400 + ARCPULL 350	COMBI ARCPULL	ARCPULL 200	ARCPULL 350
080133	080140	080164	083004	080157	080461	083011

### INCLUDED ACCESSORIES



1 BOX Dentstation Pro WD 072800



Premium pro levelling bar 900mm 071643



Premium pro levelling lever 072619  
Premium pro bar 1184 mm 072626



Manuspot 050679

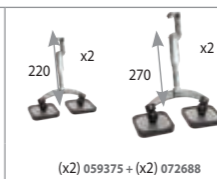

x2 220 x2 270  
(x2) 059375 + (x2) 072688



072664 + 072671 + 072640 + 072657



071650 + 072312

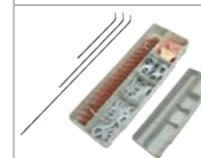

Dent box consumables 051515  
3 lifting rods 050792  
Empty box 320x113mm



Magnetic earth 049666  
Ringmatic 052154  
Manual pulling handle 057289

1 BOX STEEL ACCESSORIES PACK V2 080126



Cable support 052284



4 m³ support 059665



Arc Puller Premium Pro 072572

1 BOX ALU ACCESSORIES PACK 073838

### INCLUDED ACCESSORIES



1 BOX Dentstation Pro WD 072800

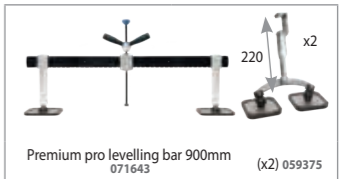

Premium pro levelling bar 900mm 071643 (x2) 059375



072664 + 072640 + 071650



Alu Ring Box 1 mm 059412



Alu hammers 020986



Arc Puller Premium Pro 072572



Set of pencil punches with 6 teflon tips 052888



3 lifting rods 050792



230V  
Stainless steel brush 044258  
Infrared Thermometer 079922  
Hot air gun 650°C 066311



4 m³ support 059665

1 BOX ARCPULL ACCESSORIES PACK 080485



# PULLING SYSTEMS



AIRFIX DRAW ALIGNER	39
DRAW ALIGNER	40
FRAME STRAIGHTENING	42



## DRAW ALIGNER

### AIRFIX DRAW ALIGNER

Air 5-8 bars

077379

080669

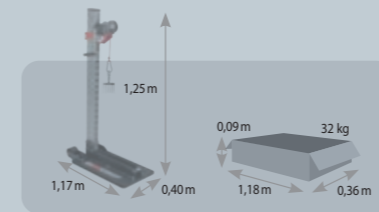

### 350 kg Uniform pulling force

Force de tirage uniforme  
Gleichmäßige Zugkraft  
Forza di spinta uniforme

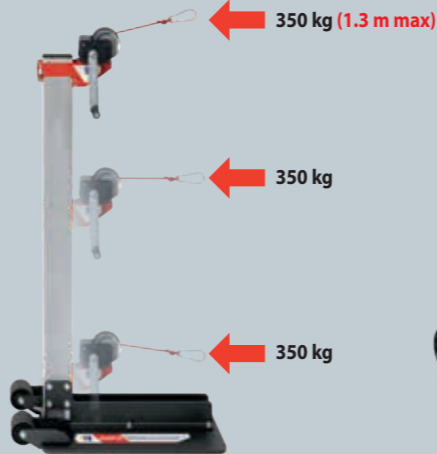

#### Precision

All directions

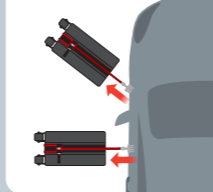

#### Down-pulling

Rocker panel  
- Bas de caisse  
- Schweller  
- Sottoporta



#### Quick & easy set up



Compact & light  
31 kg

#### Low noise

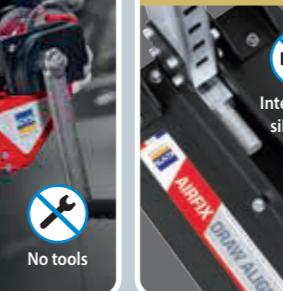

Integrated silencer

#### Smart maintenance

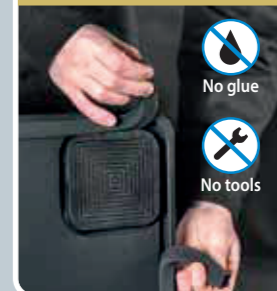

No glue

No tools



079588  
Ultra resistant  
No elasticity  
(1,5T max)  
(included)

049734  
Ø M10 / M14  
(included)

#### Options



Pads - Patins  
(x2)  
069008



Plate seal  
- Joint de plaque  
079571



12 tooth claw  
- Griffe 12 dents  
082229



Designed for

- ★ Time saving
- ★ Maximum grip
- ★ Durability

#### Ground anchor by suction Fast installation

Ancrage au sol par aspiration :  
installation rapide  
Verankerung durch Vakuumbildung -  
schnell einsatzfähig  
Ancoraggio a terra: installazione rapida



4 pads

#### Seal protection Perfect stability

4 patins : protection du joint, stabilité parfaite  
4 Pads: Dichtungsschutz, perfekte Stabilität  
4 piedini: protezione sigillata, perfetta stabilità



4 pads  
4 patins  
4 piedi

Seal - Joint - Rahmen - Guarnizione

# PULLING SYSTEMS

**DRAW ALIGNER**

Draw aligner - Équerre de tirage - Schnellausbeul-Richtausleger  
052475

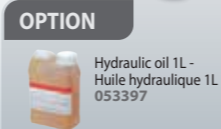
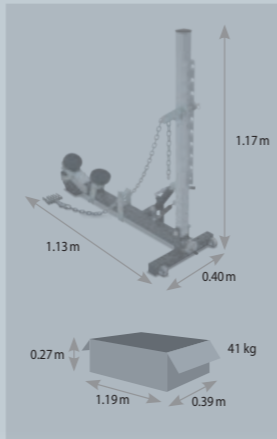
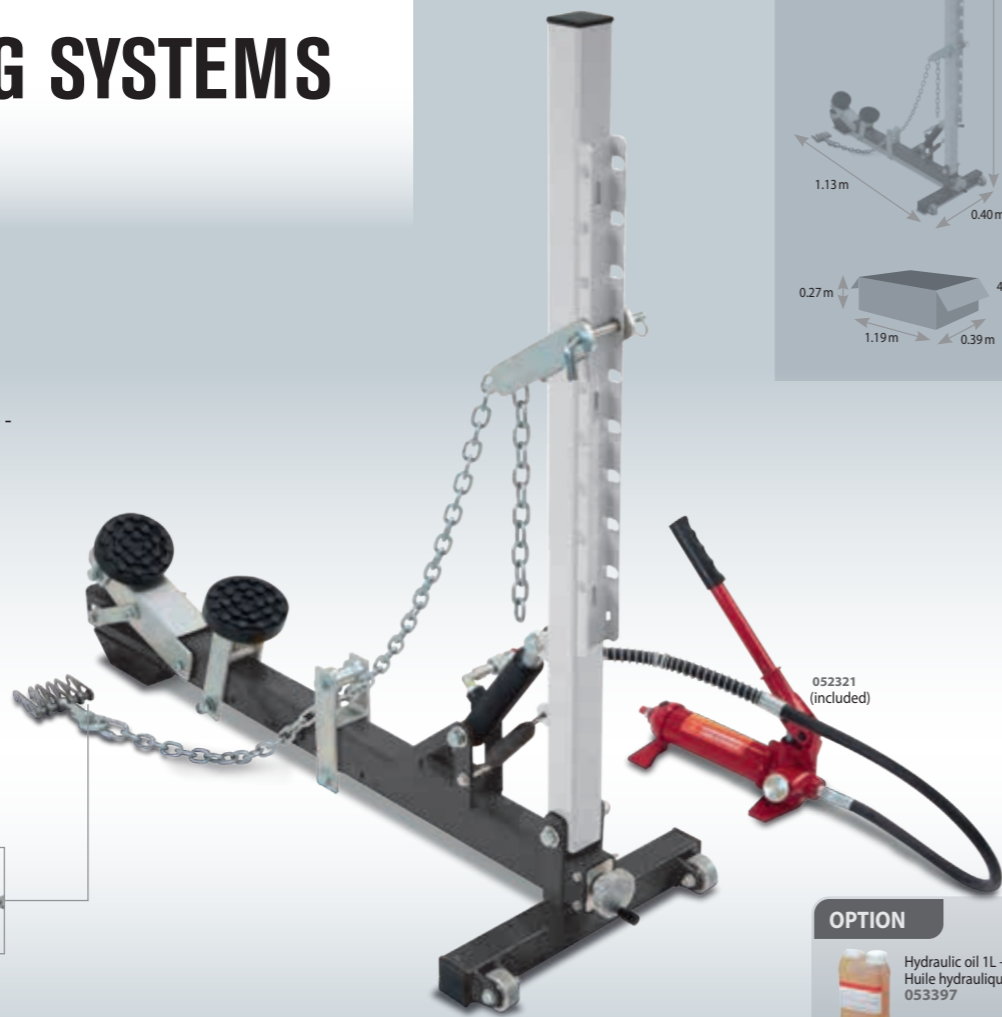
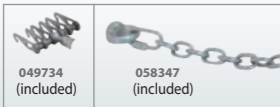
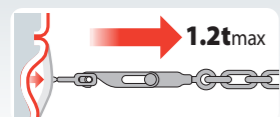
**INCLUDED**

Wedge for rocker panel - Cône pour bas de caisse

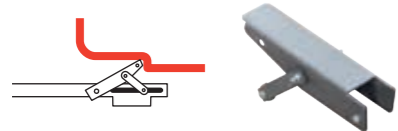

Pads kit for rocker panel - Kit patins pour bas de caisse

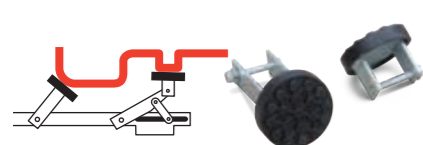
**OPTION**

Rocker panel arms for draw aligner - Bras de bas de caisse - Abstütztraverse für Richtausleger

052581

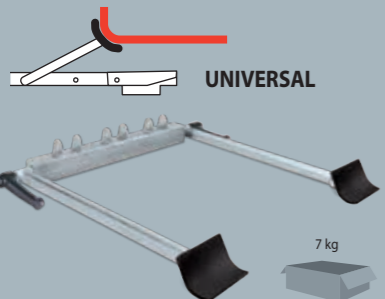
**OPTION**

12 tooth claw for pulling chain  
082229

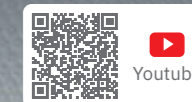
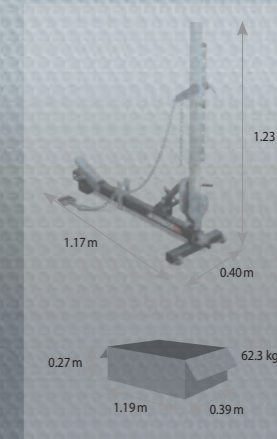
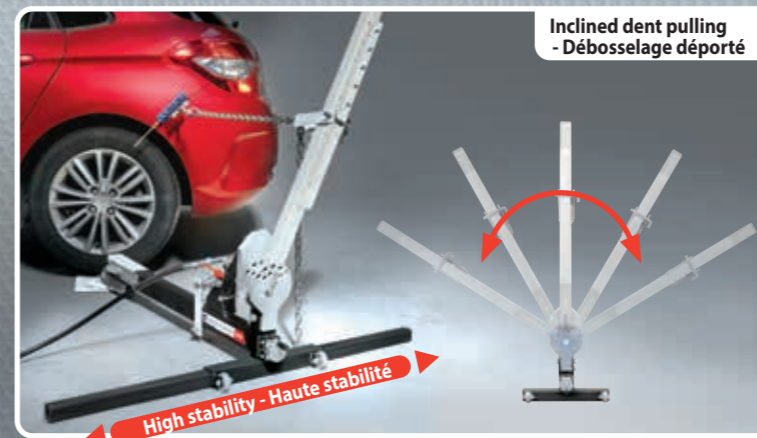
**NEW****DRAW ALIGNER PRO**

069244

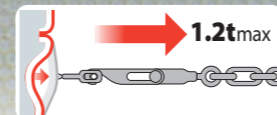

049734 (included)

058347 (included)

**OPTION****INCLUDED**

Plate under the wheel - Cône sous roue  
Compatible with Draw Aligner & Draw Aligner Pro 076693



Wedge for rocker panel - Cône pour bas de caisse

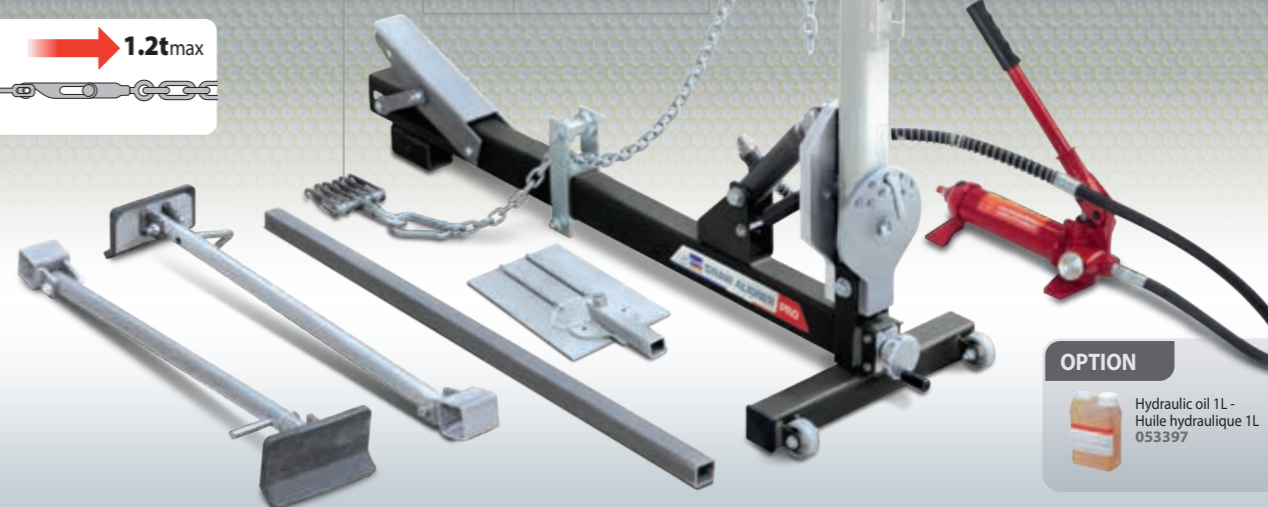
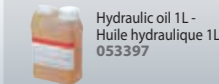

Rocker panel arms and stabilisation bar - Kit bras de bas de caisse et barre de stabilisation

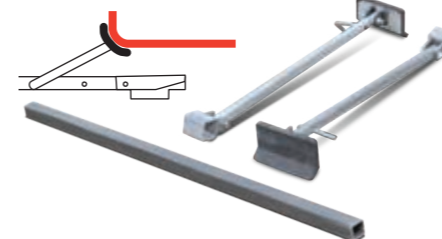
**OPTIONS**

Pads kit for rocker panel - Kit patins pour bas de caisse  
071278

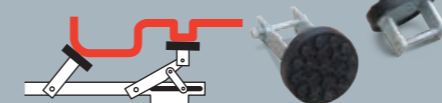

## SMART PULLER SILVER PULLING SYSTEM

- Système de tirage Smart puller silver - Schnellausbeul-Richtausleger Smart puller silver

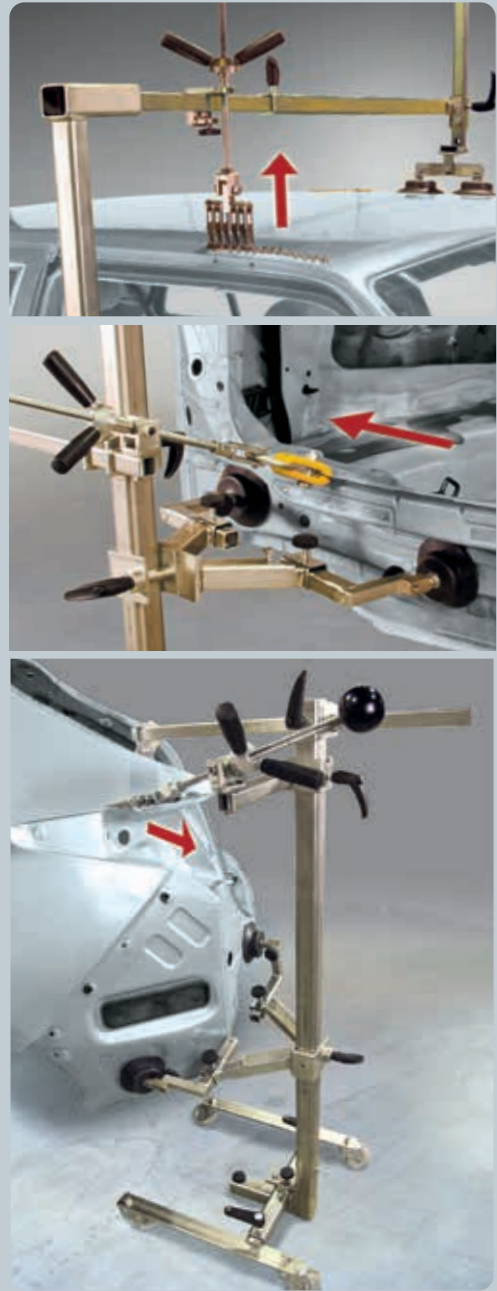

054820

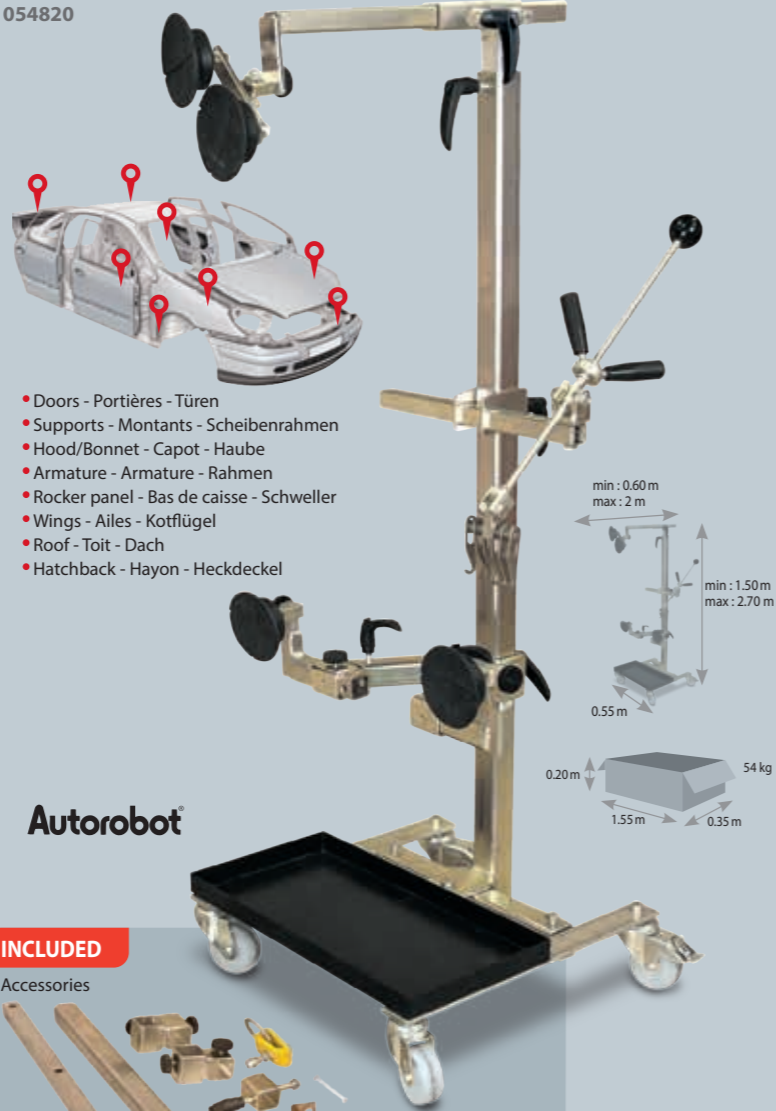

- Doors - Portières - Türen
- Supports - Montants - Scheibenrahmen
- Hood/Bonnet - Capot - Haube
- Armature - Armature - Rahmen
- Rocker panel - Bas de caisse - Schweller
- Wings - Ailes - Kotflügel
- Roof - Toit - Dach
- Hatchback - Hayon - Heckdeckel

min: 0.60 m  
max: 2 m

min: 1.50 m  
max: 2.70 m

0.55 m

0.20 m

1.55 m

0.35 m

54 kg

**Autorobot**

### INCLUDED

Accessories

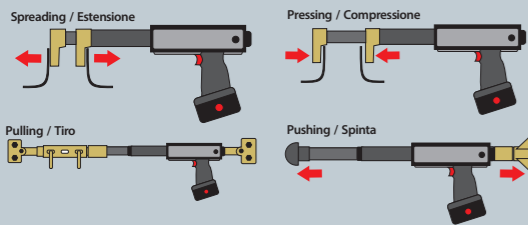

Applications / Applicazioni

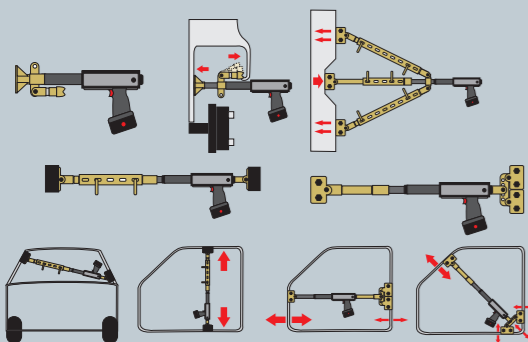

## ELECTRO POWER - Zug-Druckpresse

Non commercialisable en France

### OPTION

Pince écarteur 079496

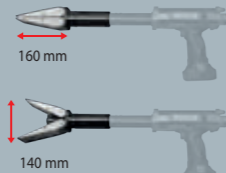

with accessories : 057425

-PULLING POWER: 5 Ton.  
-PUSHING POWER: 5 Ton.  
-PISTON  
-STROKE: 130 mm



MADE IN ITALIA

### INCLUDED

Standard kit : 425x620x210 mm  
Standard kit  
Total weight: 18 kg

057401

### INCLUDED

Accessories kit : 425x620x150 mm  
Accessories kit  
Total weight: 20 kg

057418

Li-Ion battery (included) 058514

## HYDRAULIC CYLINDER KIT - Coffret vérin hydraulique - Hydraulischer Drucksatz

MADE IN CHINA

BASIC 4T  
052345



BASIC 10T  
052338



PRO 4T  
057432



PRO 10T  
057449



### OPTIONS

Hydraulic oil 1L - Huile hydraulique 1L 053397

## ANCHOR BAR - Barre d'ancrage - Türspanner

MADE IN TAIWAN

053045

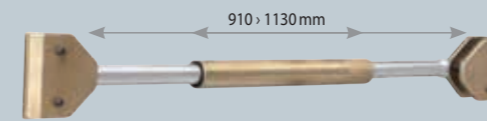

053052

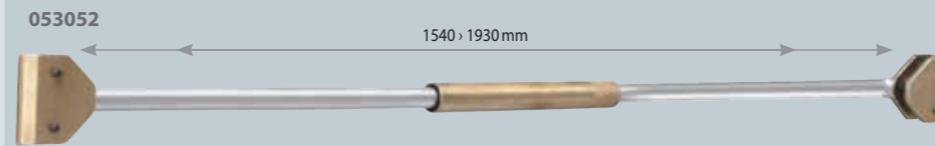

## MEASURING TOOLS - Mesures - Vermessung

BODYMETER, Mechanical measurements

052130

250 > 2230 mm

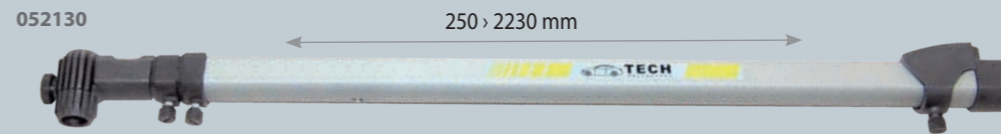

GYSMETER, Electronic measurements

052093

Measuring report



Light weight measuring arm with an easy to read digital display

400 > 2650 mm

**SWIVEL CLAMP**  
- Pince pivotante

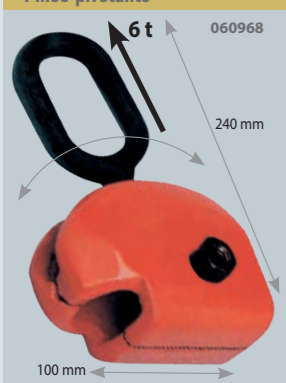

**PULL CLAMPS - Pincés de tirage - Ziehwerkzeuge**

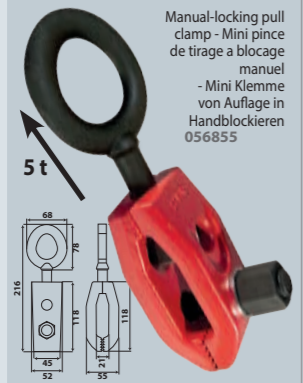

**PULL HOOK - Crochet de tirage - Ziehwerkzeuge**

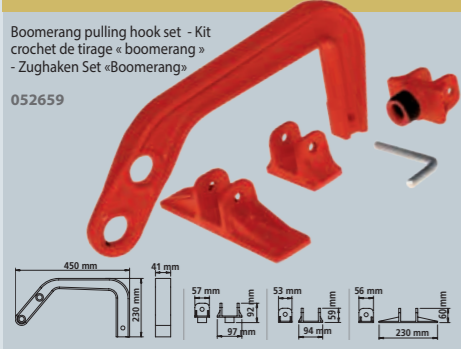

**ARCH HOOKS - Passage de roue**

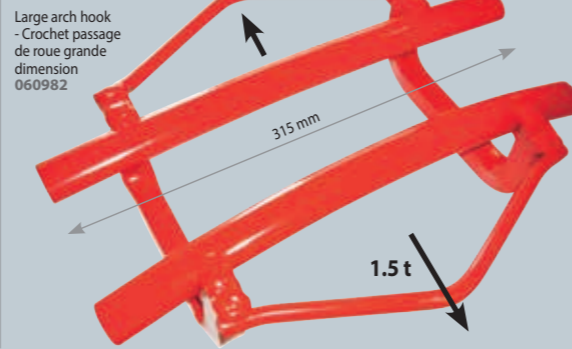
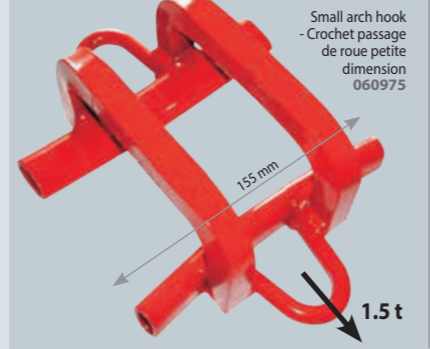

**PULLING CHAIN - Chaînes de tirage - Ziehwerkzeuge**

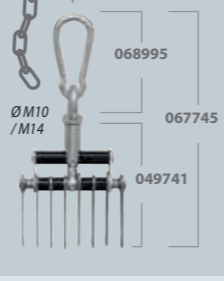
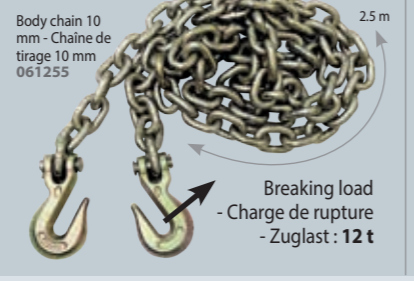
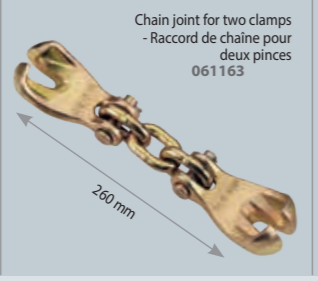
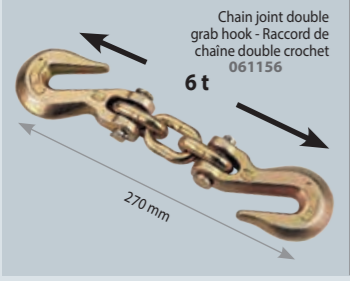

**WIDE PULL CLAMPS - Pincés de tirage larges**

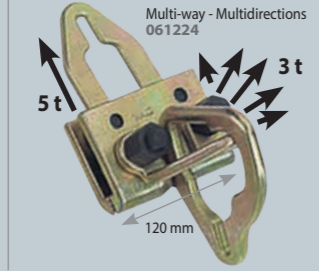
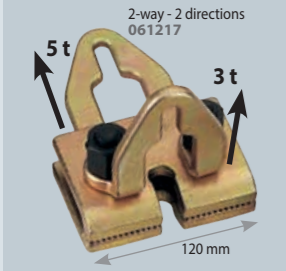

**SMALL PULL CLAMPS - Pincés de tirage faible largeur**

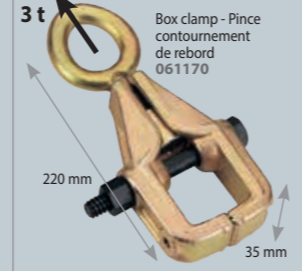
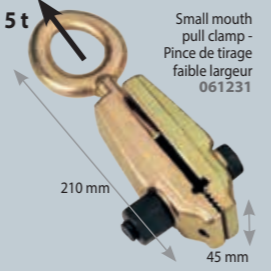
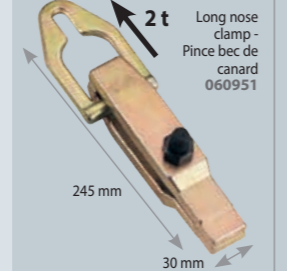

**MULTIPLE PULL CLAMP - Pince de tirage multiple**

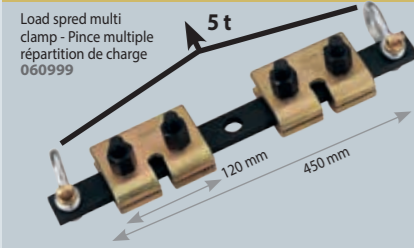

**45 MM SCISSORS CLAMP - Pince ciseaux largeur 45 mm**

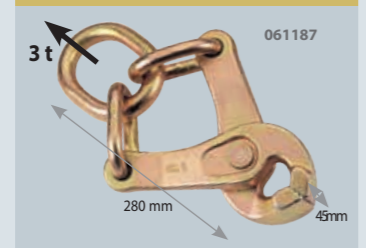

**90 DEGREE CORNER CLAMP - Pince de tirage pour angle 90°**



**C TYPE CLAMP - Pince de tirage type C**

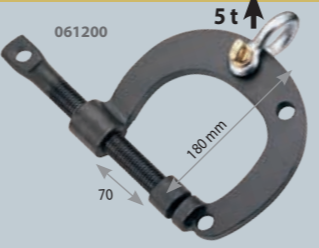

**INERTIA HAMMER KIT - Kit marteau à inertie - Ausziehhammer kit**

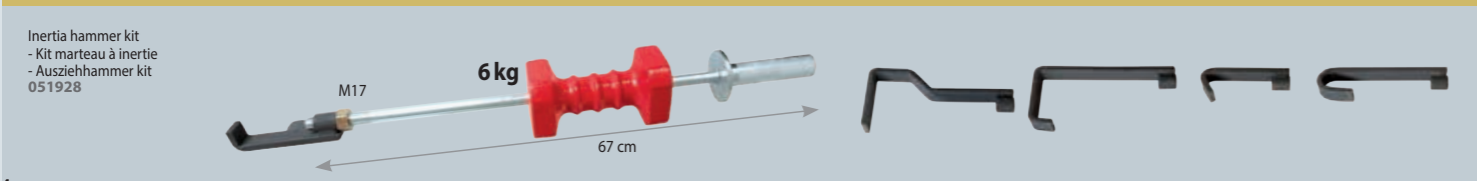

**SMART SATELLITE - Satellite intelligent- Satellite Komplett-Kit**

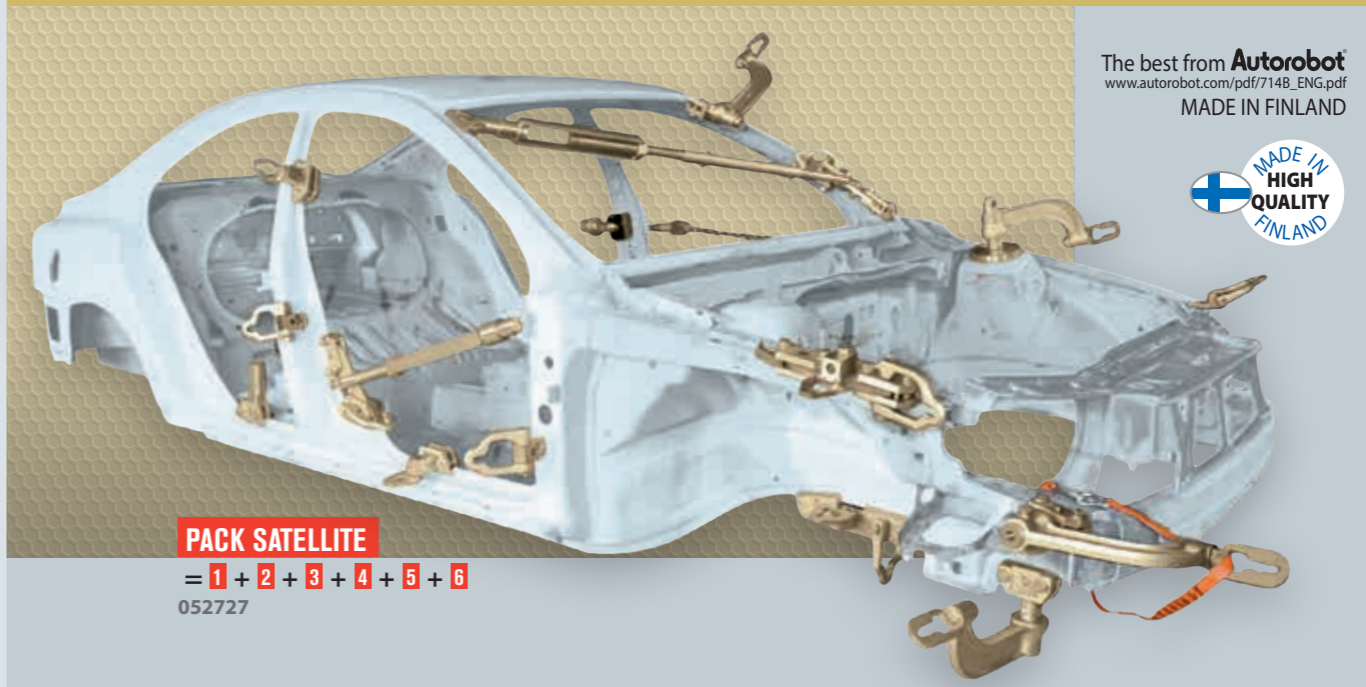

The best from **Autorobot**  
www.autorobot.com/pdf/7148\_ENG.pdf  
MADE IN FINLAND



**PACK SATELLITE**  
= 1 + 2 + 3 + 4 + 5 + 6  
052727

**1 SATELLITE**  
- Satellite - Satellite Basisbügel-Set



**2 KIT MAC PHERSON (A)**  
- Mac Pherson Kit - Befestigungs-Kit-Federbein (McPherson)



**3 BARRE POUR TIRER/POUSSER**  
- Push/Pull Bar - Zug/Druck-Stangenset

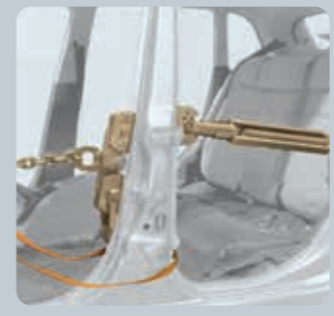
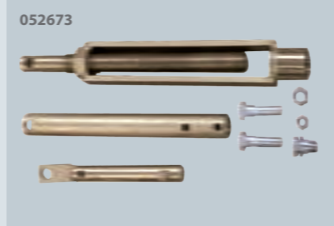

**4 SATELLITE (B)**  
- Bügelverlängerung

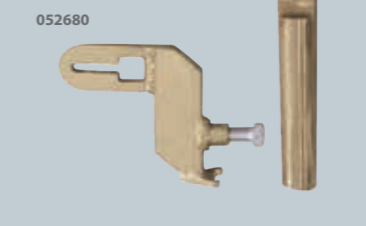

**5 SANGLE DE SÉCURITÉ**  
- Safety Strap - Sicherungsgurt



**6 DOUBLE PINCE SATELLITE (C)**  
- Double Clamp Satellite - Satellite Doppelklemme



**PINCE DE TIRAGE MULTI-USAGE**  
- Versatile pulling clamp - Multifunktions-Zugklemme

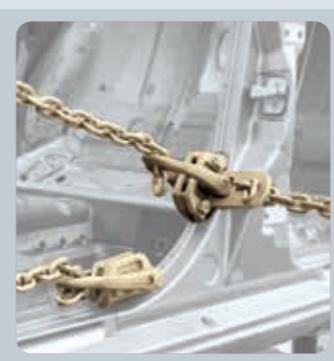

**POWER-PULLER 4T**

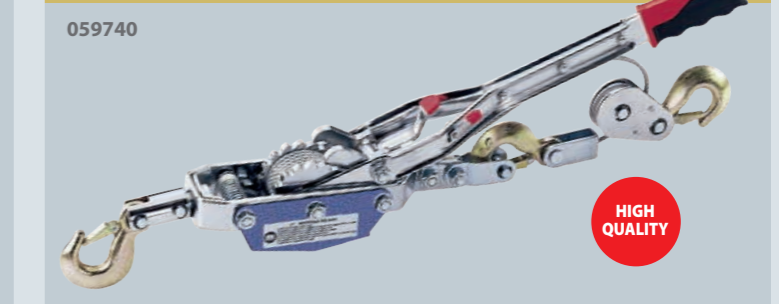

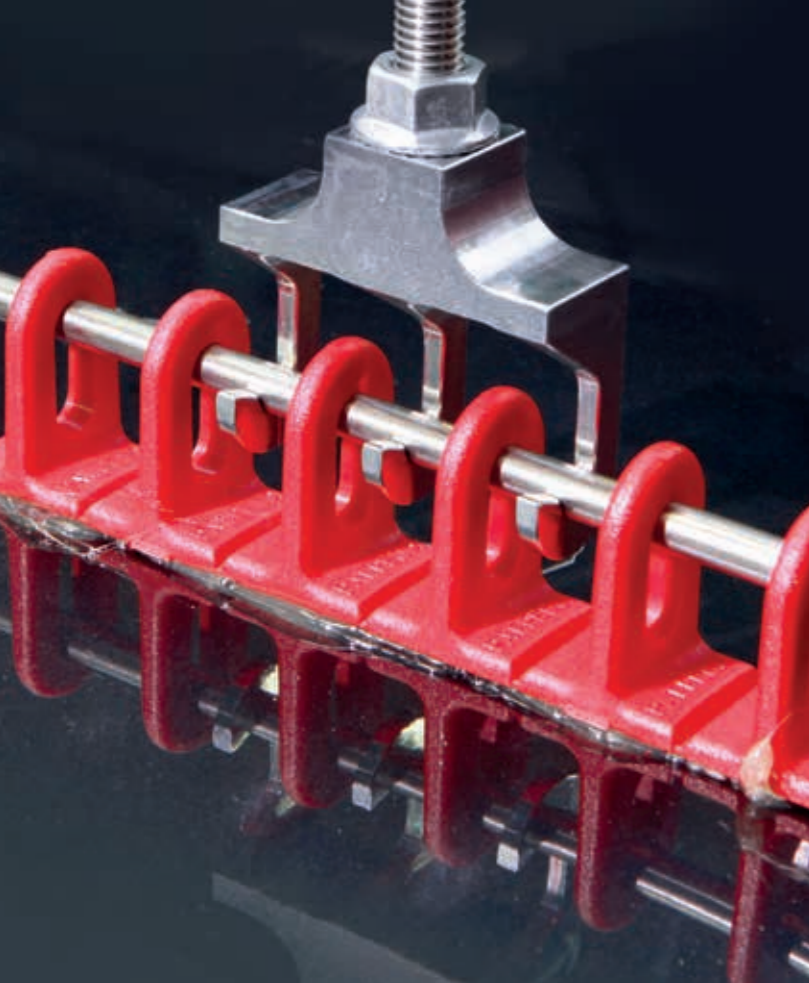

# PAINTLESS DENT REPAIR + GLUE PULLING REPAIR

## DENT PULLING INDUCTOR

- Inducteur débosselage - Dellenmatrix

GYS  
DUCTION  
AUTO + Dent pulling  
inductor  
054776

= GYS  
DUCTION AUTO  
DENT REPAIR  
054981



Youtube



Licensed by  
BETAG.Innovation

⚡	AM	⚡	Freq.	INTEGRATED TECHNOLOGY	❄️	Cable (m)	📦	⬆️
50 Hz	A	W	kHz	PFC	FV	Liquid Cooling	Inductor	LxWxH cm / kg
230V, 1~	16	2 400	35+120	▪	▪	—	2 2.5	52 x 30 x 37 / 9.4
								37 x 21 x 37 / 7.5

## DENT PULLING INDUCTOR

- Inspection carrosserie  
- Ausbeul Induktor

Planche flexible pour inspection  
de la carrosserie - Ausbeul-  
Matrix  
Ø 800 mm  
059122

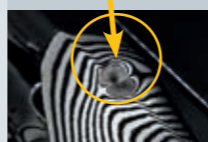

OPTION  
Freezer spray  
- Spray refroidisseur  
-50 °C  
400 ml  
(x 12)  
048898

## PAINTLESS DENT REPAIR MAGNETIC KIT

- Kit magnétique de débosselage sans peinture  
- Magnetisches Ausbeul-Kit

053168

EXELTOOLS



1010 mm - 40"

705 mm - 28"

610 mm - 24"

510 mm - 20"

## PAINTLESS DENT REPAIR LAMPS

- Lampes de débosselage  
- Ausbeullampe

ULTRA LIGHT CARBON X40 PW  
053175

EXELTOOLS



150 mm  
- 6"

300 mm - 12"

## DENT PULLING KIT (PAINTLESS)

- Kit débosselage sans peinture - Dellenausbeulhebel-Set

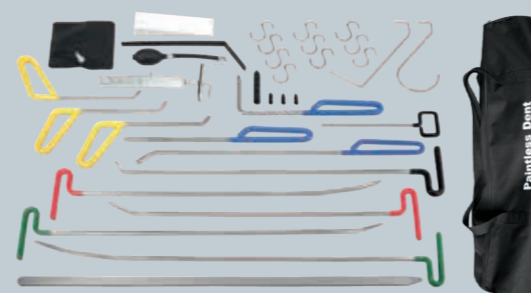

33  
parts

051959

## SET OF 6 PENCIL PUNCHES

- Kit de 6 coins de frappe - Beulenstemmer-Satz mit 6 Tefloneinsätzen

052888

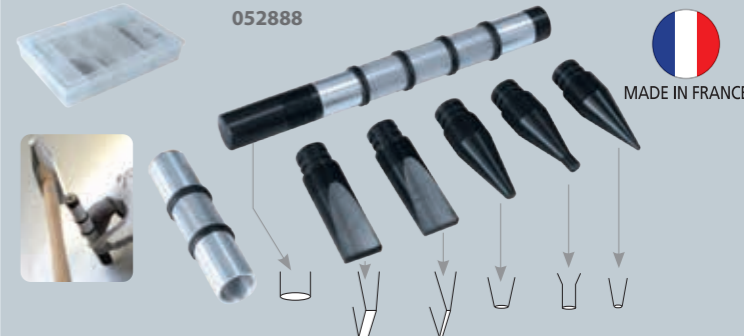

MADE IN FRANCE

## PNEUMATIC INERTIA HAMMER

- Marteau inertie pneumatique - Unterdruck-Schlaghammer

2.5 kg



Ø 60 (x1)

Ø 120 (x1)

Ø 150 (x1)

051904

## AIR CUSHION KIT

- Kit coussins gonflables - Luftpolster-Spreizkissen-Satz



051942

## PUMP AIR SUCTION SLIDE HAMMER

- Marteau à inertie à ventouses (pompage manuel) - Man. Unterdruck-Schlaghammer

1,1kg

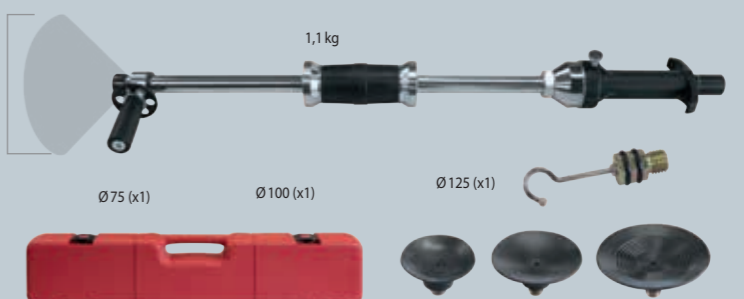

Ø 75 (x1)

Ø 100 (x1)

Ø 125 (x1)

048683





PDR: Paintless Dent Repair  
- Débosselage rapide et sans peinture  
- Lackschadenfreies Ausbeulen

# PAINTLESS DENT REPAIR

## GLUE PULLER PRO (Acier/Alu • Steel/Alu)



Glue Puller PRO  
058699

x6  
050952



x10  
050976

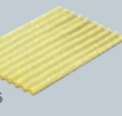

050983



Glue Puller PRO  
EXPORT  
230 V 059160

## BARRETTES ANNEAUX PLASTIQUE - Plastic Multipads Ösen-Klebe pads

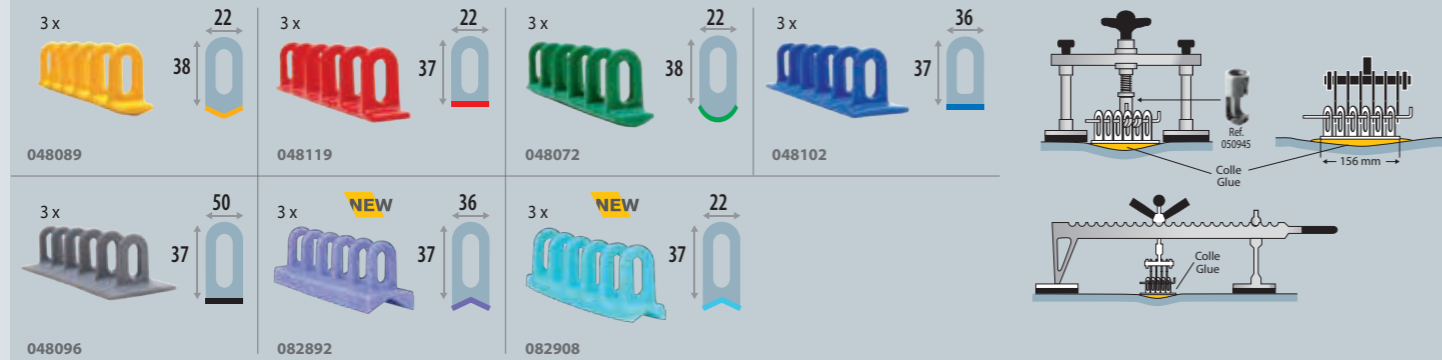

## OPTIONS

Pulling handle 3 claws - Poignée de tirage 3 dents - Handzugkralle 3-fach  
057326



Slide hammer 380 g  
- Marteau à inertie 380 g  
- Gleithammer 380 g

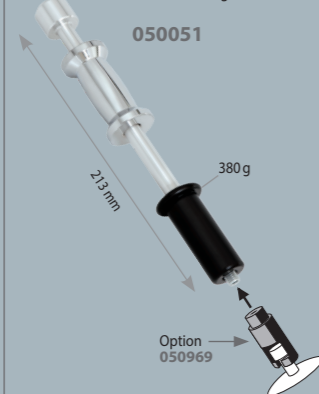

Slide hammer 500 g  
- Marteau à inertie 500 g  
- Gleithammer 500 g

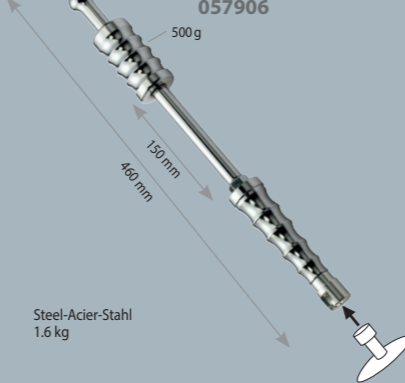

Set of 2 knives to cut glued reinforcements  
- Jeu de 2 couteaux pour découpe de renforts colles  
- 2-er Set Messer zur Klebepadentfernung

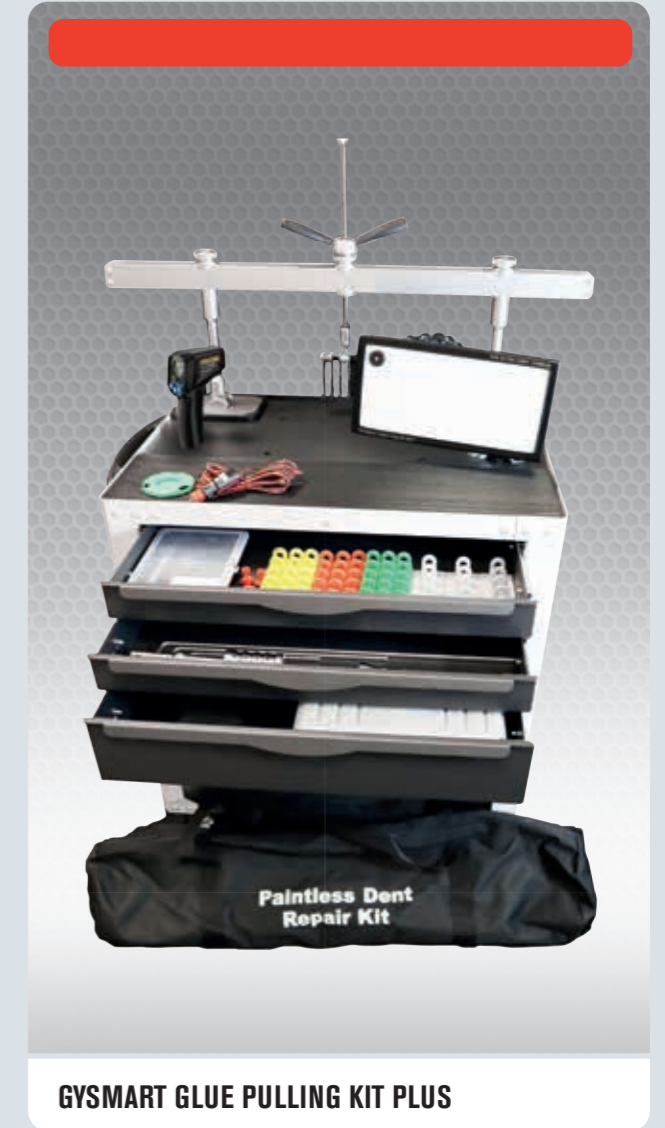

Workstation 054233	Set of pencil punches with 6 teflon tips 052888	Infrared thermometer 079922 Heat Gun 066311	Levelling bar 050693 6 Gripping multihook head 049734	3 Lifting rods 150/300/500 mm 050792	Set of 3 conical plastic multipads 048096 048072 048089 048119 048102	Inertia hammer 057906	Set of 6 glue tips 050952	Glue Puller PRO 058699	Glue Puller PRO Export 059160	33PC Paintless dent repair kit 051959 PDR Light ultra light carbon X40PW 053175	Mini puller 050921 Aluminium clamp 2 050945
-----------------------	--	--	--	---	--	--------------------------	------------------------------	---------------------------	----------------------------------	--	--

GYSMART GLUE PULLING KIT 076051					✓						
GYSMART GLUE PULLING KIT EXPORT 076105				✓					✓		
GYSMART GLUE PULLING KIT PLUS 076082					✓						✓
GYSMART GLUE PULLING KIT PLUS EXPORT 076129				✓						✓	



GPR: Glue Pulling Repair  
- Débosselage par colle  
- Lackschadenfreies Ausbeulen

# GLUE PULLING REPAIR



## GPR I-BAR MINI



080324



## GPR FLEXIBLE TABS



## GPR FLAT TABS



## GPR 3D TABS



## GPR 3D CURVE TABS

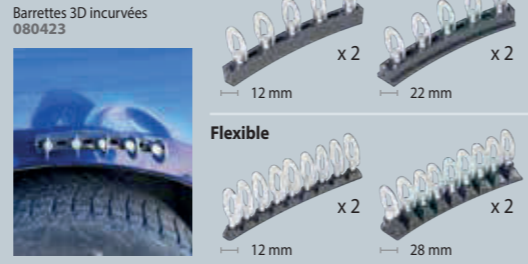

## GPR UNIVERSAL TABS

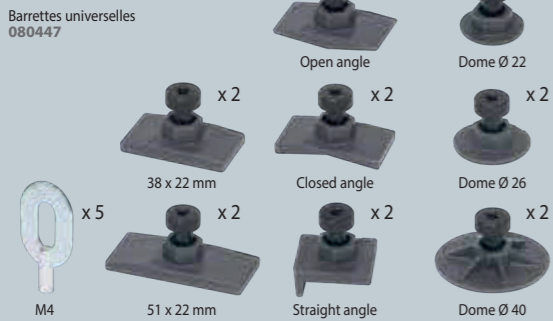

## GPR FOLD TABS

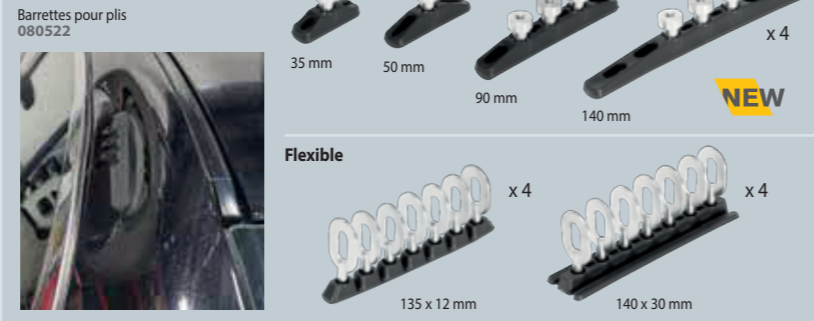

## GPR HAIL IMPACT TABS



## GPR BAR TABS

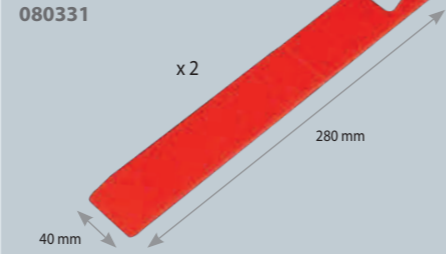

## GLUE GUN 400W - Pistolet à colle chaude 400W

082144



GPR Glue sticks  
- Bâtons de colle  
080454

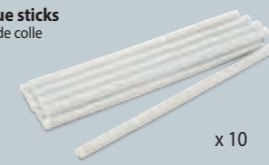

GPR Glue sticks for stripped sheets  
- Bâtons de colle pour tôles découpées  
081017

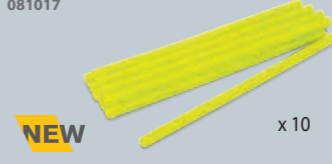

Workstation Premium -  
Servante Premium  
076143



## GPR PRO KIT

080317



1	GPR I-bar mini	51 mm	x 1
<b>GPR Flexible tabs</b>			
2	64 x 20 mm		x 1
	64 x 38 mm		x 1
	64 x 51 mm		x 1
<b>GPR Long tabs</b>			
3	152 x 38 mm		x 1
	152 x 51 mm		x 1
<b>GPR Plastic hooks</b>			
4			x 10
<b>GPR Bar tab</b>			
5			x 1
<b>GPR 3D tabs</b>			
6	12 mm		x 1
	22 mm		x 1
<b>GPR 3D curved tabs</b>			
7	51 x 38 mm		x 1
	101 x 38 mm		x 1
<b>GPR M4 steel hooks</b>			
8			x 5
<b>GPR Universal tabs</b>			
	Flat 38 x 22 mm		x 1
	Flat 51 x 22 mm		x 1
9	Open angle 38 x 22 mm		x 1
	Closed angle 38 x 22 mm		x 1
	Straight angle 27 x 22 mm		x 1
	Dome Ø 22 mm		x 1
	Dome Ø 26 mm		x 1
	Dome Ø 40 mm		x 1
<b>GPR Flat tabs</b>			
	Ø 13 mm		x 1
	Ø 23 mm		x 1
10	Ø 27 mm		x 1
	Ø 32 mm		x 1
	Ø 38 mm		x 1
	Ø 52 mm		x 1
<b>GPR Bars for folds</b>			
	35 mm		x 1
	50 mm		x 1
	90 mm		x 1
	140 mm		x 1
	Flexible 135 mm		x 1
	140 x 30 mm		x 1
11	<b>GPR Glue sticks</b>		x 5
12			

Isopropyl alcohol  
99.9% + spray - Alcool  
isopropyloque 99.9% +  
vaporisateur  
082236



Heat gun - Décapeur  
thermique  
066311



Gas hot air gun  
- Pistolet à air chaud  
autonome à gaz  
060777



Blow torch - Lampe à  
souder  
052741



Novacet +  
Butane/Propane/Propylène  
040441



Infrared  
thermometer  
- Thermomètre infrarouge  
079922



Set of 6 pencil  
punches - Kit de 6  
coins de frappe  
052888



3 plastic wedges  
- 3 cales plastiques  
051294



Lifting rod 180 mm  
- Tige de tirage 180 mm  
082915



Pulling hand 3  
claws - Poignée de  
tirage 3 dents  
057326



Slide hammer 500g  
- Marteau à inertie 500g  
057906

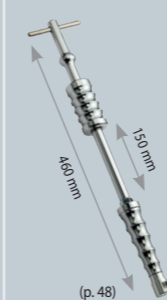

Slide hammer 1.7kg  
- Marteau à inertie 1,7kg  
051201

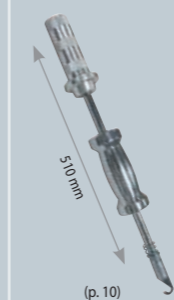

Glue Lifter  
057364



Arc Puller  
Premium  
065161



Arc Puller  
Premium Pro  
072572



Premium Pro  
Levelling bar  
900 mm  
071643

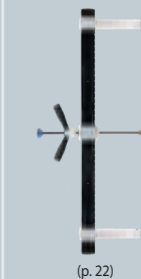

Airfix Draw Aligner  
077379





# SPOT WELDING

TECHNOLOGY 54

GVSPOT 32D-X & 100R-CX 56

GVSPOT BP-LX 58

PTI-S7 59

X & C ARMS 60

BP GENIUS 62

PTI PREMIUM PRO 64

PTI GENIUS 66

G ARMS 68

ACCESSORIES & CONSUMABLES 69

# ÉVOLUTION TECHNOLOGIQUE

TECHNICAL IMPROVEMENTS - TECHNISCHE ENTWICKLUNG - MEJORAS TECNICAS

- Facteurs d'évolution :
  - Challenge CO2 = faible poids
  - Crash test = ★★★★★
  - Anti corrosion = nouveaux revêtements
  - Esthétique et visibilité plus sophistiquées.

- Evolution factors :
  - CO2 Challenge = low weight
  - Crash test = ★★★★★
  - Anti-corrosion = new coatings
  - Improved aesthetics and demand for better occupant visibility.

- Entwicklungsfaktoren :
  - CO2 Challenge = geringes Gewicht
  - Crash-Test = ★★★★★
  - Anti-Korrosion = neue Beschichtung
  - Modernes Technik-Design.

- Fattori di evoluzione :
  - Sfida CO2 = basso peso
  - Crash test = ★★★★★
  - Nuovi rivestimenti = anticorrosivi
  - Estetica e visibilità più sofisticate

2004

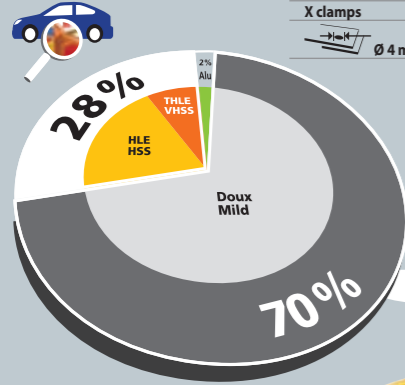

OLD SOLUTIONS

- Traditional machines
- 180 daN max
- 6500 A max
- X clamps
- Ø 4 mm max

2024

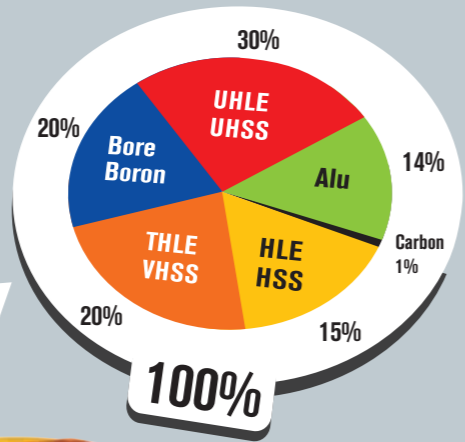

GYS SOLUTIONS

- INVERTER Technology
- 550 daN max
- 14500 A max
- X & C clamps
- Liquid cooled system
- Ø 10 mm

- HSS - HLE
- VHSS - THLE
- UHSS - UHLE
- Bore - Boron
- Aluminium

An example of new generation car body  
 • Exemple de carrosserie nouvelle génération  
 • Beispiel einer Karosserie der neuen Generation  
 • Esempio di carrozzeria di nuova generazione

## HOMOLOGATIONS PRODUITS

MANUFACTURER APPROVALS / COMPLIANCE - PRODUKT HOMOLOGATIONEN - PRODOTTI APPROVATI



Category	Model	Volvo	Jeep	Mercedes	Smart	Ford	GM	Subaru	Tata	Becher	Kia	Nissan	Hyundai	Toyota	Land Rover	Jaguar	Ford USA	Honda USA	NIO	BYD	Others	
DENT PULLER	GYSPT 26.02/27.02																					
	GYSPT 36-39.02/04, PRO230/400, EXPERT 200/230/400																					
	Workstations																					
	GYSPT ALU FV																					
	GYSPT ARCPULL 200																					
RESISTANCE SPOT WELDER	GYSPT 100R																					
	GYSPT BP-LX																					
	GYSPT BP-LC-s7																					
	GYSPT BP GENIUS																					
	GYSPT PTI-s7																					
	GYSPT PTI PREMIUM PRO																					
	GYSPT PTI GENIUS																					
	VAS 821 101 - Spot Welder																					
RIVE TING	GYSPRESS																					
	CARMIG																					
MIG / MAG	E1 GYS AUTO																					
	E2 E3 GYS AUTO																					
	AUTOPULSE 220-M1																					
	AUTOPULSE 220-M2																					
	AUTOPULSE 220-M3																					
	AUTOPULSE 320-T1																					
	AUTOPULSE 320-T3																					
PLASMA	VAS 821 005 - Pulse MIG																					
	VAS 821 00580 023																					
	EASYCUT 40																					
	CUTTER 25K/35KF																					
GYSDUCTION AUTO	CUTTER 30FV/45CT																					
	GYSDUCTION AUTO																					

## RANGE

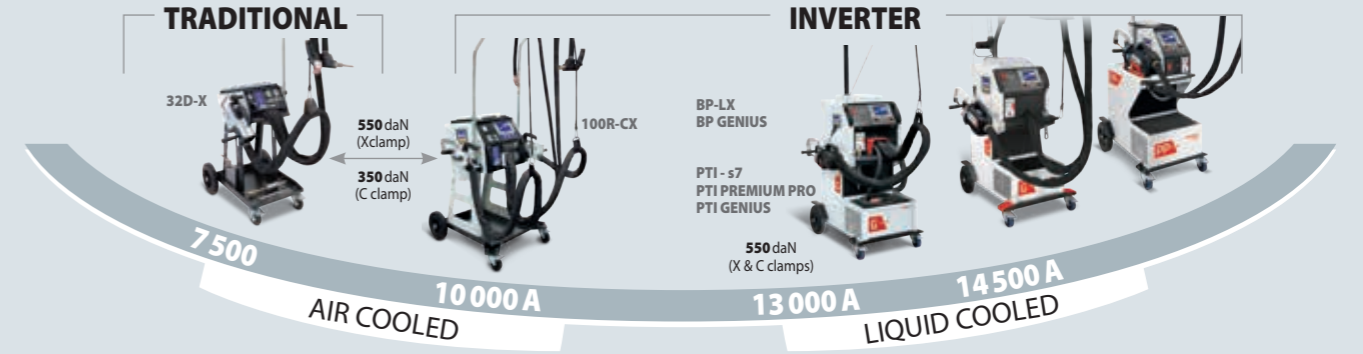

	32 D	100 R	BP / BP GENIUS	PTI-s7	PTI PREMIUM PRO	PTI GENIUS
--	------	-------	----------------	--------	-----------------	------------

Mild - Doux	•	•	•	•	•	•
HSS/VHSS - HLE/THLE → ⚠	X	•	•	•	•	•
UHSS/BORON - UHLE/BORE	X	Difficult	•	•	•	•

Number of spots - Nombre de points 10 spots/min	0.8 + 0.8 mm	100	150	no limit	no limit	
	2.5 + 2.5 mm	5	10	95	60	> 200

Inverter Technology	—	•	•	•	•
EMF Directive 2013/35/UE (⚡)	—	—	<b>BODY PROTECT TECHNOLOGY</b>	•	•
Cooling system - Système de refroidissement	<b>AIR</b> 🌀	<b>AIR</b> 🌀	<b>LIQUID</b> 🌊	<b>LIQUID</b> 🌊	<b>LIQUID</b> 🌊
Automated regulation - Régulation automatique	I (A)	—	•	•	•
	daN	—	•	•	•
	⚡	irregular	<b>constant</b>	<b>constant</b>	<b>constant</b>

<b>MODE AUTO</b>	—	—	• (LC, LG)	•	
Pince - Clamp	X	• (32DX)	• (B.P.LX)	—	
	C	—	• (B.P.LG)	• G clamp	
	X+C	—	• (100R-CX)	—	
Transformer Inside Clamp	—	—	—	•	
Cables (L)	2.5 m	2.5 m	2.5 m	4 or 6 m	6 m
Includes gun 🔫	•	•	•	option	

Max welding frequency (spots/min) - Cadence de soudage maximale (points/min)	0.8 + 0.8 mm	10	10				BP-LG : 20			10	20
	2.5 + 2.5 mm	6	2	6	10	2	6	10	10	20	
Fuse	400 V	32 A	32 A	40 A	50 A	32 A	40 A	50 A	20 A	25 A	
	200/208-240 V	—	—	—	—	60 A	80 A	100 A	40 A		



# SPOT WELDING

### PORTASPOT 230

## 6 300 A 120 daN

Air cooled

230V  
022256

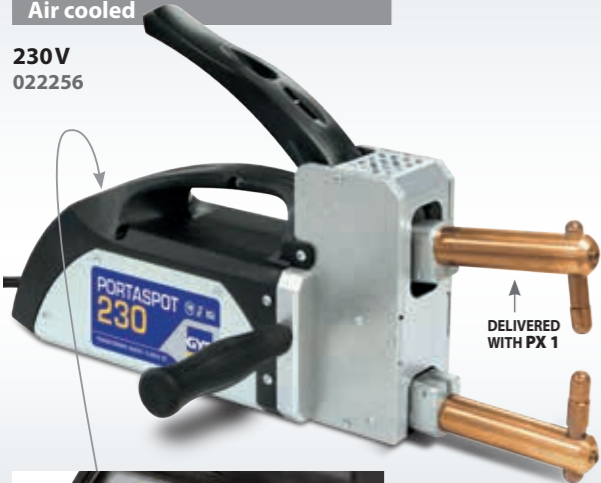

DELIVERED WITH PX 1



#### ARMS Ø 23 mm

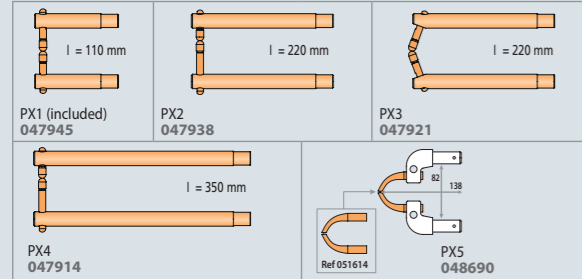

#### ELECTRODES

EX40 Short electrode 40 mm 047884	EX60 Medium electrode 60 mm 047891	EX80 Long electrode 80 mm 047907
---	--	--

#### CAPS & ACCESSORIES

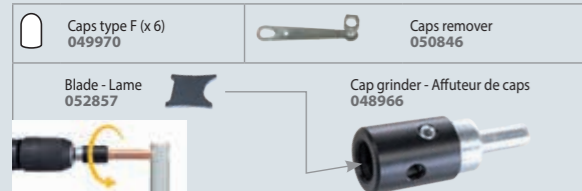

50/60 Hz	A	A	A	mm	V	m	mm <sup>2</sup>	LxWxH cm / kg
1 x 230V	16(D)	6 300	8 900	2+2	2.45	2.5	3x2.5 H05VVf	OK 41 x 18 x 22 / 11.3

### GYSPOT 32D-X

## 7 500 A 500 daN

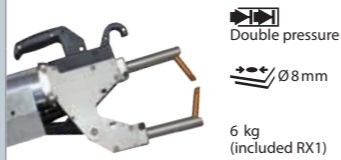

Air cooled

2 x 400V  
019881



	included
Monopoint/Spot 049291	■
Inertia hammer 049482 + 049802	■
Spotter box pro 050075	■
Top support box	■
Contact grease 050440	■
Caps remover 050846	■
Cable support	■
RX1 051034	■
RX2 051041	■

#### OPTIONS



### GYSPOT 100R-CX

## 10 000 A 550 daN (X) 350 daN (C)

For mild steel, HSS, UHSS

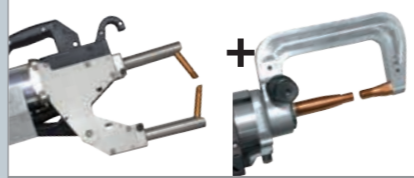

3 x 400V  
022317

	included
Monopoint/Spot 049291	■
Inertia hammer 049482 + 049802	■
Spotter box pro 050075	■
Top support box	■
Contact grease 050440	■
Caps remover 050846	■
Cable support	■ x 2
RX1 051034	■
RX3 051058	■
RC1 051065	■
RC2 051072	■
RC3 051089	■



#### OPTIONS 100R-CX

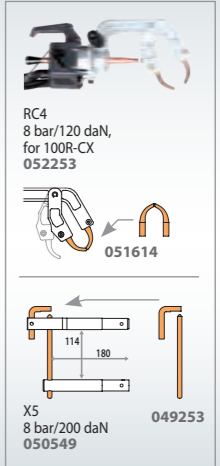

MADE IN FRANCE CE NORM. 62135	50/60 Hz	A	Spots/min (max)	RMS	MAX	mm	Uo	Cables			100% CU	LxWxH cm / kg
								A	A	A		
GYSPOT 32D.X	400V	32 (13 kVA)	6	7 500	10 500	3 + 3	1,2 + 3	2,2	200	OK	79 x 57 x 54 / 111	
								2,5	150			
								8	3 x 6 HO7RNF			
GYSPOT 100R.CX	3 x 400V	40 (28 kVA) 50 (35 kVA)	2 6 10	10 000	—	2.5+2.5+2.5	1,5 + 3	2,5	200	OK	61 x 79 x 71 / 137	
								2,5	150			
								8	4 x 6 HO7RNF			

**GYSPOT BP-LX**  
**13 000 A**  
550 daN

For mild steel, HSS, UHSS **Boron steel**

Double pressure  
Ø 10 mm  
6.5 kg (included X1)

Liquid cooled

**BP BODYPROTECT**  
Unique electro-magnetic field protection  
2013/35/UE by GYS

Traceability software  
Save spot welding configuration and export data

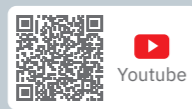

019652

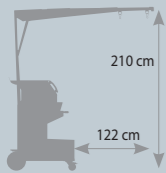

	019652	058804
	<b>400V</b>	
Gyspot BP-LX	▪	▪
Monopoint/Spot 049291	▪	▪
Spotter box pro (p.10) 050075	▪	▪
Inertia hammer 049482 + 049902	▪	▪
X1 050501	▪	▪
X4A (x2) + X4B + X4C + X2 020733	▪	▪
Liquid cooling (10L) 052246	▪	(x3)

**GYSPOT PTI-s7**  
**14 500 A**  
550 daN

For mild steel, HSS, UHSS **Boron steel**

FUSE 20 A  
Double pressure  
Ø 10 mm  
9.9 kg (included C1)

**TRANSFORMER INSIDE**

Liquid cooled

Traceability software  
Save spot welding configuration and export data

020894

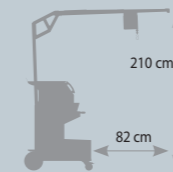

	6M 022195	6M 020900	4M 020894	4M 067998
	<b>220V</b>		<b>400V</b>	
Gyspot PTI-s7	▪	▪	▪	▪
Contact grease 050440	▪	▪	▪	▪
Caps remover 050846	▪	▪	▪	▪
Arm panel	▪	▪	▪	▪
C1 021402	▪	▪	▪	▪
C2 + C3 + C4 060821	▪	▪	▪	▪
C6 022409	▪	▪	▪	▪
Gyro 360° 051720	▪	▪	▪	▪
Complete gun kit 067318	▪	▪	▪	▪
Liquid cooling (10L) 052246	▪	▪	▪	(x3)

**Very light**  
9.9 kg

**CONVERT PTI S-7 > PTI PREMIUM PRO WITH G ARMS**

KIT RENOV PTI PREMIUM PRO 220V 072367

400V 072541

C ARMS → G ARMS

**OPTION**

200 mm<sup>2</sup> 1.6 m  
300 mm<sup>2</sup> 1m

Complete gun kit 067318

GYRO 360° for PTI 051720

High stability Compatible gyro

**OPTIONS**

050068 x10 (x20: 052239) x6 (x6: 049994)	x18 (x6: 049987) x18 (x6: 049970)	SD CARD 050914 2 GB	Cooling liquid - Liquide de refroidissement - Kühlmittel - Enfriamiento líquido - Refrigeracao liquida 2L 082212 5L 062511 10L 052246	Protection cover - Housse de protection - Schutzhaube 050853	Mandrels for gun - Mandrins pour pistolets - Pistole & Anschlußstücke, Zubehör S1 < nov 2010 048171 S2 > nov 2010 048188
--	--------------------------------------	------------------------	--	---	--

MADE IN FRANCE 62135	50/60 Hz	A D curve	Spots/min (max) ± 2.5+2.5	I RMS A	U <sub>o</sub> V	mm			Cables			100 % CU	cm	kg
						↕	↔	↔	↔	↔	↔			
<b>GYSPOT BPLX</b>	3 x 400 V	32 (22 kVA) 40 (28 kVA) 50 (35 kVA)	2 6 10	13 000	16	2.5+2.5+2.5	1.5 + 3	2.5, liquid	2.5	8 m, 4x6 HO7RNF	OK	65 x 80 x 205	164.5	
<b>GYSPOT PTI-s7</b>	3 x 400 V	20 (14 kVA)	10	14 500	7.3			4 m, liquid 6 m, liquid		8 m, 4x4 HO7RNF	OK	65 x 80 x 230	105.3	
<b>GYSPOT PTI-s7 220 V</b>	3 x 200 208 220 240	40 (14-16 kVA)	10	12 500 13 000 14 500 14 500	6.5 6.7 7.4 7.7	2.5+2.5+2.5	1.5 + 3	4 m, liquid 6 m, liquid	OPTION 067318 : 1.6 m, Ø 200 mm <sup>2</sup>	8 m, 4xAWG8 (SOOW)	OK	65 x 80 x 230	115.7	

FOR GYSPOT 32D-X, 100R-CX, BP-LX

550 daN

6,5 kg including X1

- DOUBLE PRESSURE
- LIQUID COOLED / REFRIGÉRATION LIQUIDE
- Ø 10 mm

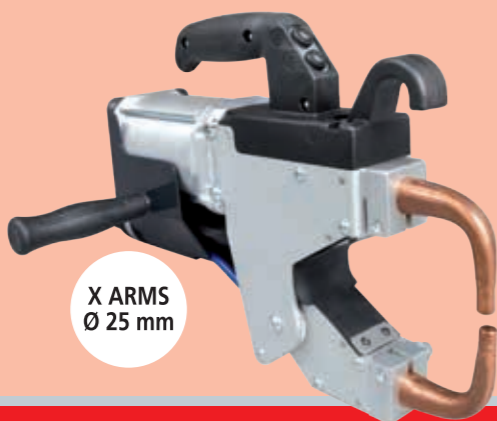

X ARMS Ø 25 mm

X Arms - Caps Ø13 mm

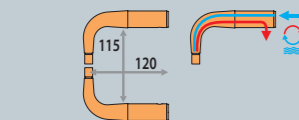

X1 8 bar/550 daN 050501

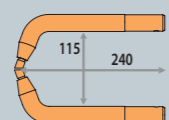

X2 8 bar/400 daN 050518

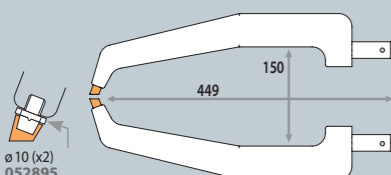

X4 8 bar/120 daN 050532

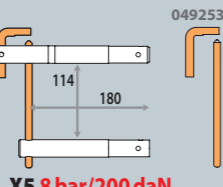

X5 8 bar/200 daN 050549

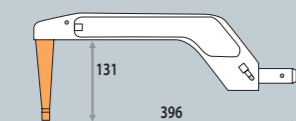

X4A 8 bar/150 daN 020702

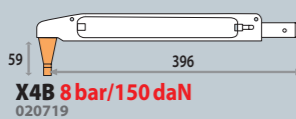

X4B 8 bar/150 daN 020719

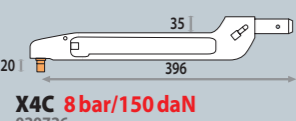

X4C 8 bar/150 daN 020726

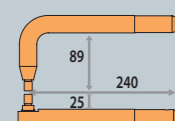

X6 8 bar/400 daN 050587

X4 (A, B & C) combinations

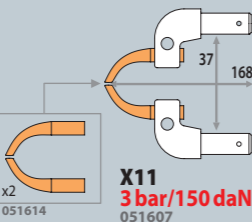
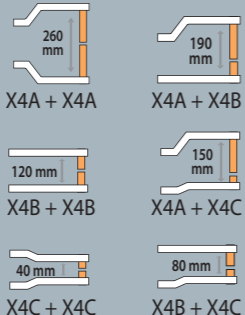

X11 3 bar/150 daN 051607

X ARMS PANELS

X4A (x2) + X5 + X2 022324

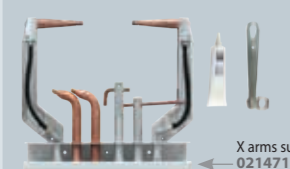

X arms support 021471

X4A (x2) + X4B + X4C + X2 020733

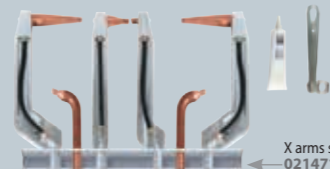

X arms support 021471

Remote control (BP)



Digital screen control Change Mode & Parameters



X clamp control



C clamp control



C ARMS PANELS



C2 + C3 + C4 060821



C2 + C3 + C6 + C9 = 061316

2 BOXES



C10 + C3 + C5 + C6 + C9 = 076495

NEW

FOR GYSPOT PTI

550 daN

Transformer inside

9,9 kg including C1

- DOUBLE PRESSURE
- AIR COOLED + LIQUID COOLED / DOUBLE REFRIGÉRATION AIR + LIQUIDE
- Ø 10 mm

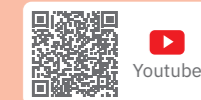

C Arms - Caps Ø13 mm

Classic arms



CLASSIC FINISH

Bras isolés - Isolated arms - Isolierte Bügel

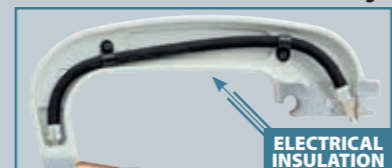

ELECTRICAL INSULATION

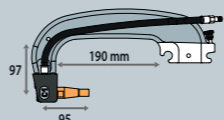

C1 8 bar/550 daN 021402

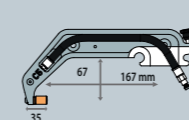

C5 8 bar/550 daN 022393

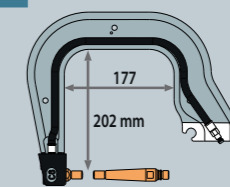

C8 8 bar/550 daN 021440

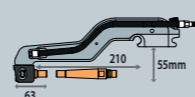

C2 8 bar/550 daN 022386

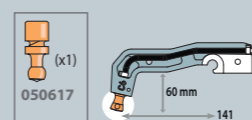

C6 8 bar/300 daN 022409



C3 8 bar/550 daN 021419

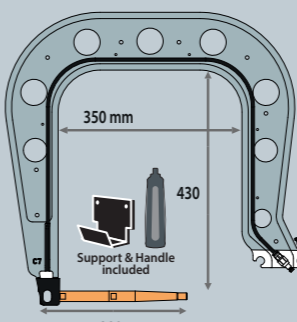

C7 8 bar/550 daN 021433

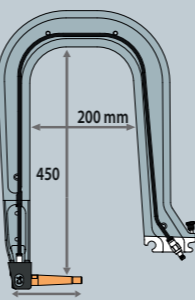

C4 8 bar/550 daN 021426

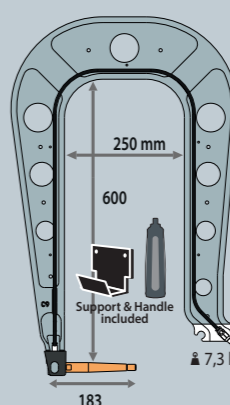

C9 8 bar/550 daN 020078

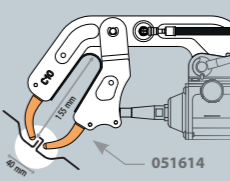

C10 4 bar/150 daN 051638

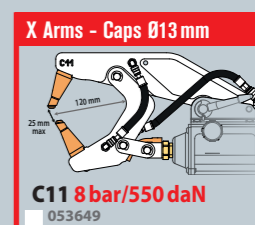

C11 8 bar/550 daN 053649

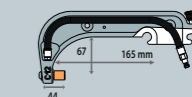

C12 8 bar/550 daN 022997

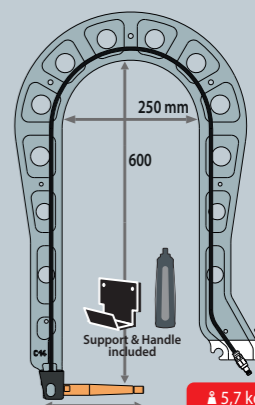

C14 8 bar/400 daN 023543

5,7 kg 22% saved

Option for C7



C7-SA (Small Access) 067684

63 318

Option for C9 & C14

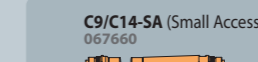

C9/C14-SA (Small Access) 067660

63 220

# SPOT WELDING BP GENIUS

**G**  
ARMS



MADE IN FRANCE

G-clamp front body + protection 078765



**ULTRA LIGHT & COMPACT**  
6.5 kg  
(Gyro & G1 included)

550 daN

LIQUID COOLED  
REFROIDISSEMENT  
LIQUIDE  
Ø 10 mm

6.5 kg  
(Gyro & G1 included)



**OPTIONS**

<p><b>Caps type A box</b> 048935 x40 (x6: 049987)</p> <p><b>Caps type F box</b> 077119 x40 (x6: 049970)</p>	<p>x20 (x6: 049987)</p> <p>x6 (x6: 049970)</p> <p>x2 (x1: 050617)</p> <p>073449</p>	<p>SD CARD 050914</p>	<p>Cooling liquid - Liquide de refroidissement - Kühlmittel - Enfriamiento líquido - Refrigeração líquida</p> <p>2L 082212 5L 062511 10L 052246</p>	<p>Protection cover - Houise de protection - Schutzhaube</p> <p>for BP &amp; PTI 050853</p>	<p>10-14 kg 059696</p>
---	---	---------------------------	---	---	----------------------------

**FAST OPEN XL**

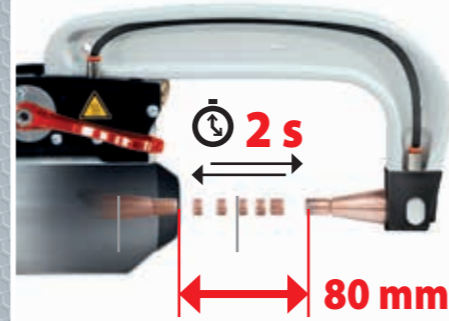

**EASY**



**GYRO INTEGRATED**



**PERFECT ELECTRICAL CONNECTION**



**AUTO**

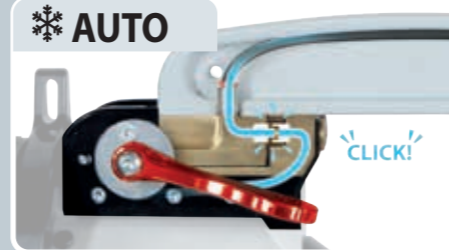

**GYSPOT  
BP GENIUS**

**13 000 A**  
550 daN

For mild steel, HSS, UHSS **Boron steel**

**BP** BODYPROTECT  
Unique electro-magnetic field protection by GYS

Traceability software  
Save spot welding configuration and export data

023451

**NEW**

	023550	023451	082250
Gyspot BP GENIUS	<b>220V</b>	<b>400V</b>	
Monopoint/Spot 049291	▪	▪	▪
Spotter box pro (p.10) 050075	▪	▪	▪
Inertia hammer 049482 + 049802	▪	▪	▪
Caps remover 050846	▪	▪	▪
Arm support	▪	▪	▪
G1 022768	▪	▪	▪
G2 + G3 + G4 022898	▪	▪	▪
Liquid cooling (10L) 052246	▪	▪	(x3)
Caps type A box 048935	▪	▪	▪
Protection cover 050853	▪	▪	▪



MADE IN FRANCE 62135	50/60 Hz	A D curve	Spots/min (max) 2.5+2.5	I <sub>RMS</sub> A	U <sub>o</sub> V	mm			Cables			100% CU	cm	kg
						⚡	⚡	⚡	⚡	⚡	⚡			
<b>GYSPOT BP GENIUS 220 V</b>	3 x	200 208 220 240	2 6 10	10 500 11 000 12 000 12 500	15 15.5 17 18	2.5+2.5+2.5	1.5+3	2.5 m, Ø 200 mm <sup>2</sup> , Liquid	2.5 m, Ø 150 mm <sup>2</sup> air	8 m 4x16 mm <sup>2</sup> (6AWG) 500W	OK	65 x 80 x 205	178	
														32 (22 kVA)
														40 (28 kVA) 50 (35 kVA)
<b>GYSPOT BP GENIUS 400V</b>	3 x 400V	32 (22 kVA) 40 (28 kVA) 50 (35 kVA)	2 6 10	13 000	16	2.5+2.5+2.5	1.5+3	2.5 m, Ø 200 mm <sup>2</sup> , Liquid	2.5 m, Ø 150 mm <sup>2</sup> air	8 m 4x6 mm <sup>2</sup> H07RNF	OK	65 x 80 x 205	171	





GYS POT

# SPOT WELDING PREMIUM PRO

**G**  
ARMS



**FULL  
ERGONOMIC**

10.3 kg  
(Gyro & G1 included)

550 daN

LIQUID COOLED  
REFROIDISSEMENT  
LIQUIDE  
Ø 10 mm

10.3 kg  
(Gyro & G1 included)

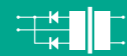

**TRANSFORMER INSIDE**

**GYRO INCLUDED**



**PERFECT ELECTRICAL CONNECTION**

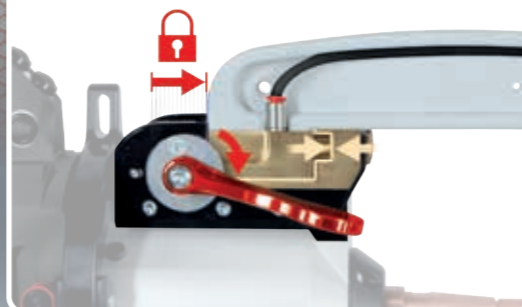

**AUTO**

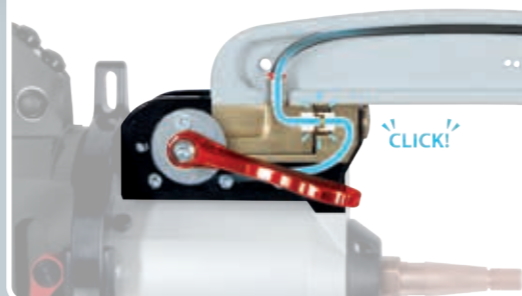

**Ergonomy & Security**

20°

**EASY  
HANDLE**



**LOCKING  
SYSTEM**



**XL Balancer**

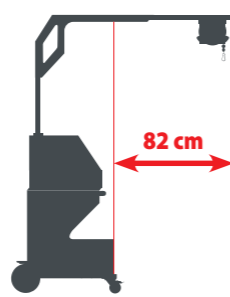

**G-arms storage**



G Arms p.60

**OPTIONS**

	Caps type A box 048935	x40 (x6: 049987)		Caps type F box 077119	x40 (x6: 049970)		Cooling liquid 2L 082212 5L 062511 10L 052246		SD CARD 050914		073449
--	---------------------------	---------------------	--	---------------------------	---------------------	--	--	--	-------------------	--	--------

**GYSPTI  
PTI PREMIUM PRO**

**14500 A**  
550 daN

For mild steel, HSS, UHSS

Boron steel



**TRANSFORMER INSIDE**

Liquid cooled

Traceability software  
Save spot welding configuration  
and export data

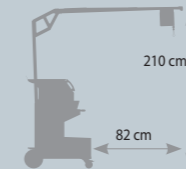

10.3 kg

	6M		
	220V	400V	NEW
GYSPTI INVERTER PTI PREMIUM PRO	072206	072183	082243
Caps remover 050846	▪	▪	▪
Arm panel	▪	▪	▪
G1 022768	▪	▪	▪
G2 + G3 + G4 022898	▪	▪	▪
Liquid cooling (10L) 052246	▪	▪	(x3)
Caps type A box 048935	▪	▪	▪
Protection cover 050853	▪	▪	▪



**OPTIONS**

**G11**  
for PTI PREMIUM  
PRO only

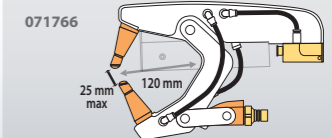

MADE IN FRANCE	50/60 Hz	Spots/min (max)	RMS	U <sub>o</sub>	mm	Cables			100% CU	cm	kg	
						3 x	6 m, liquid	8 m, 4x4 H07RN-F				
<b>GYSPTI PTI PREMIUM PRO 220V</b>	3 x 200 208 220 240	10	12500 13000 14500 14500	6.6 6.9 7.3 7.9	2.5+2.5+2.5	1.5+3	6 m, liquid	OPTION 067226; 1.8 m, Ø 300 mm <sup>2</sup>	8 m, 4x4 H07RN-F	OK	65 x 100 x 230	118.7
<b>GYSPTI PTI PREMIUM PRO 400V</b>	3 x 400V	10	14500	7.3	2.5+2.5+2.5	1.5+3	6 m, liquid	OPTION 067226; 1.8 m, Ø 300 mm <sup>2</sup>	8 m, 4x4 H07RN-F	OK	65 x 100 x 230	109.2



65

GYSPTI PREMIUM PRO

LIQUID COOLED



GYSPOT

# SPOT WELDING GENIUS



MADE IN FRANCE

550 daN

LIQUID COOLED  
REFROIDISSEMENT  
LIQUIDE  
Ø 10 mm

11.3 kg  
(Gyro & G1 included)

G  
ARMS

G-clamp front  
body + protection  
078765

NEW

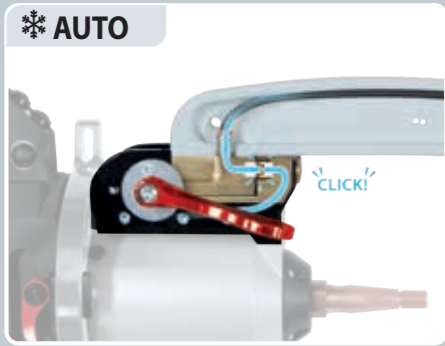
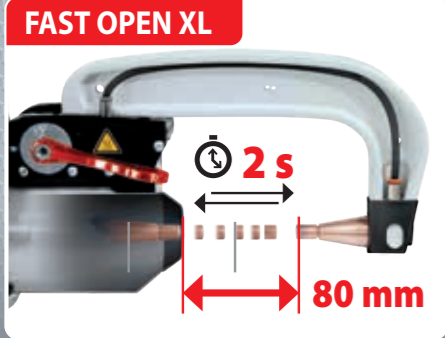

TRANSFORMER  
INSIDE

Control command  
- Contrôle de commande



### OPTIONS

- Caps type A box 048935 (x6: 049987)
- Caps type F box 077119 (x40: 049970)
- x20 (x6: 049987)
- x6 (x6: 049970)
- x2 (x1: 050617)

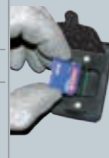

## GYSPOT PTI GENIUS

14 500 A  
550 daN

For mild steel, HSS, UHSS Boron steel

TRANSFORMER INSIDE

Liquid cooled

Traceability software  
Save spot welding configuration and  
export data



NEW

	024854	024878	082267	024892
	220V	400V	480V	
Gyspot PTI-GENIUS				
Caps remover 050846	▪	▪	▪	▪
Arm support	▪	▪	▪	▪
G1 022768	▪	▪	▪	▪
G2 + G3 + G4 022898	▪	▪	▪	▪
Liquid cooling (10L) 052246			(x3)	
Caps type A box 048935			▪	
Protection cover 077126			▪	

Ergonomic

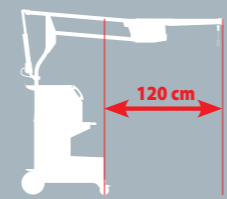

Included  
Cable support  
ULTRA  
RESISTANT



Control  
Commande



Electrode storage  
- Rangement pour  
électrodes

ELECTRIC  
MOTOR

6 m

High stability -  
Grande stabilité

### OPTIONS

Kit gun 067226



300 mm<sup>2</sup> 1.8 m 300 mm<sup>2</sup> 1m

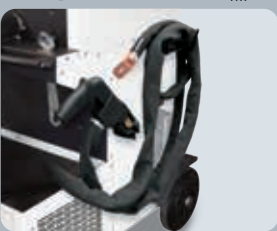

MADE IN FRANCE 62135	50/60 Hz	A D curve	Spots/min (max) 2.5+2.5	RMS A	Uo V	mm		Cables		cm	kg	
						mm	mm	mm	mm			
GYSPOT PTI GENIUS 220 V	3 x	208 220 240	50 (17-21 kVA)	20	12 500	6.6	2.5+2.5+2.5	1.5+3	6 m, Liquid	8 m 4xAWG8 (500W)	71 x 90 x 200	136.2
					13 000	6.9						
					14 500	7.3						
GYSPOT PTI GENIUS 400V	3 x 400 V	25 (17 kVA)	20	14 500	7	2.5+2.5+2.5	1.5+3	6 m, Liquid	8 m 4x4 mm <sup>2</sup> H07RN-F	71 x 90 x 200	127.7	
					7							
GYSPOT PTI GENIUS 480V	3 x 480 V	20 (17 kVA)	20	14 500	7	2.5+2.5+2.5	1.5+3	6 m, Liquid	8 m 4xAWG12 (500W)	71 x 90 x 200	128.7	

GYSPOT PTI GENIUS

LIQUID COOLED



FOR GYSPOT BP GENIUS, PTI PREMIUM PRO & PTI GENIUS

G Arms - Caps Ø13 mm

Bras isolés - Isolated arms - Isolierte Bügel

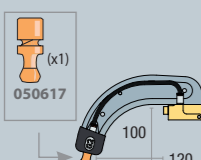

G2 8 bar/300 daN 022775

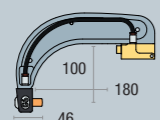

G6 8 bar/550 daN 022812

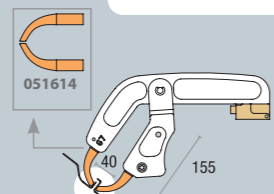

G7 4 bar/150 daN 022829

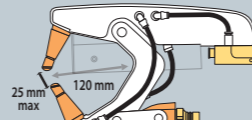

G11 8 bar/550 daN for PTI PREMIUM PRO only 071766

Kit de maintenance connecteurs pince G - Connectors maintenance kit for G clamp 067295

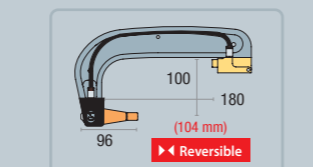
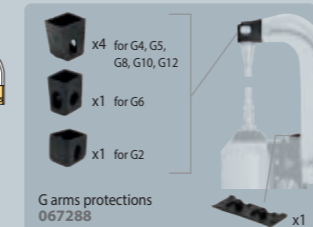

G1 8 bar/550 daN 022768

Option for G1 & G3

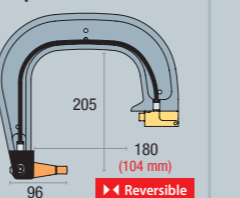

G3 8 bar/550 daN 022782

G1/G3-SA (Small Access) 067653 (for arms > 02/2021)

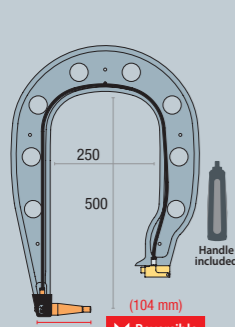

G4 8 bar/550 daN 022799

Option for G4

G4-SA (Small Access) 064478 (for arms < 01/2021)

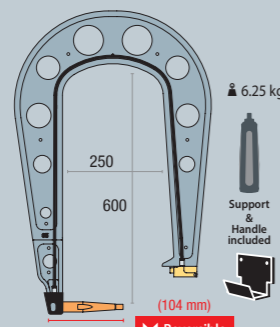
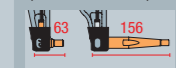

G5 8 bar/550 daN 022805

Option for G5

G5/G10-SA (Small Access) 067660

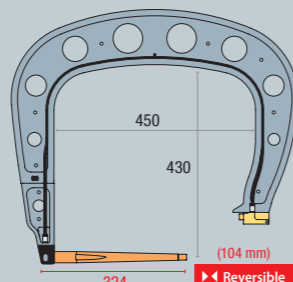

G8 8 bar/550 daN 022836

Option for G8

G8-SA (Small Access) 067677

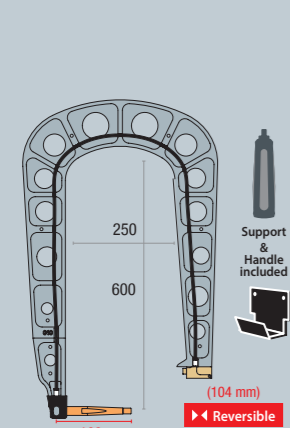

G10 8 bar/400 daN 067165

Option for G10 & G12

G5/G10/G12-SA (Small Access) 067660

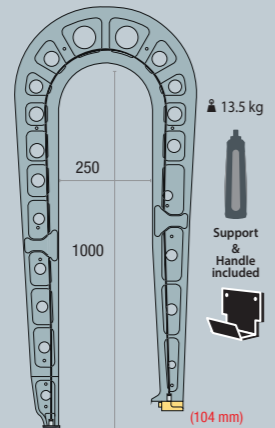

G12 8 bar/300 daN 075238

Option for G9

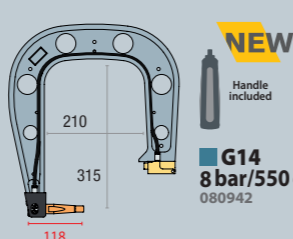

G14 8 bar/550 daN 080942

NEW

G X AUTOMATIC WELDING FOR X1, X2 & X6

G9 8 bar/550 daN not for PTI PREMIUM PRO

G9 with X1 Included 022881

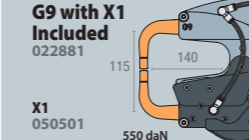

X1 050501 550 daN

G9 with X6 Included 072275

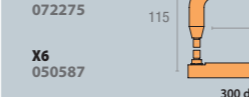

X6 050587 300 daN

Option SD card 050914

Option PCB 97449C

G ARMS PANELS

- G2 + G3 + G4 022898
- G2 + G3 + G5 063297

KIT SMALL ACCESS GENIUS for PTI GENIUS 077072

- included SA 073579
- + G1/G3-SA (Small Access) 134
- + G5/G10/G12-SA (Small Access) 220
- + G4-SA (Small Access) 150
- + G8-SA (Small Access) 368



ACCESSORIES & CONSUMABLES

X/C/G CONSUMABLES - Consommables X/C/G

- Type A Cor X clamp Ø 13 mm (x6) 049987
- Type B Cor X clamp Ø 13 mm / Ø 5 mm (x6) 055506
- Type D Cor X clamp Ø 13 mm (x10) 058507
- TYPE F For single sided gun Ø 13 mm (x6) 049970
- TYPE G Ø 13 mm (x10) 059672
- Caps inclinés - Beveled X2, X4, C11 arms Ø 13 mm (x6) 049994

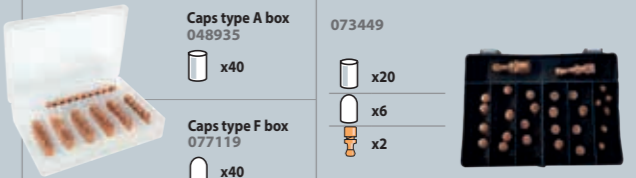

Caps type A box 048935 x40

073449

Caps type F box 077119 x40

x20 x6 x2

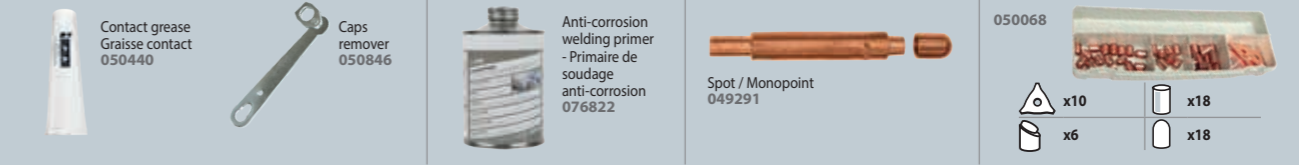

CAP GRINDER - Affuteur de caps



STEEL SHEET TRACTION BENCH

Banc de traction arrache tôle - Blech-Zugbank zur Festigkeitsprüfung



GYRO 360°

for PTI 051720



WELD TEST KIT - Valise test soudure HLE / THLE - Schweißtestkit im Hartschalenkoffer



ANTI-ARC PROTECTION 12V - Protection anti-arc 12 V - Lichtbogenschutz 12V - Protección anti-arco 12V



PROTECTION COVER - Housses de protection - Schutzhaube



SHEETS SET - Échantillons de tôles



ELECTRODE FORCE SENSOR - Capteur d'effort

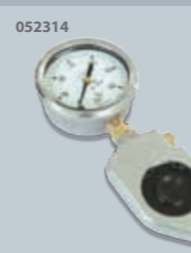

TANK DRAINING KIT - Kit de purge réservoir - Kit zur Tankentleerung



SD MEMORY CARD - Carte mémoire SD



KIT WIFI



COOLING LIQUID - Liquide de refroidissement - Kühlmittel - Enfriamiento líquido - Refrigeração líquida

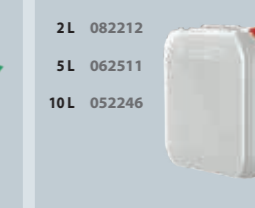



# RIVETING

GYPRESS 10T	71
GYPRESS PREMIUM 10T PP	73
WORKSTATION	74
ADAPTERS	76
DIES BOXES & RIVETS	78
ACCESSORIES	81



GYPRESS



## GYPRESS 10T

6.5 bar 100 kN

10t

063303

070653

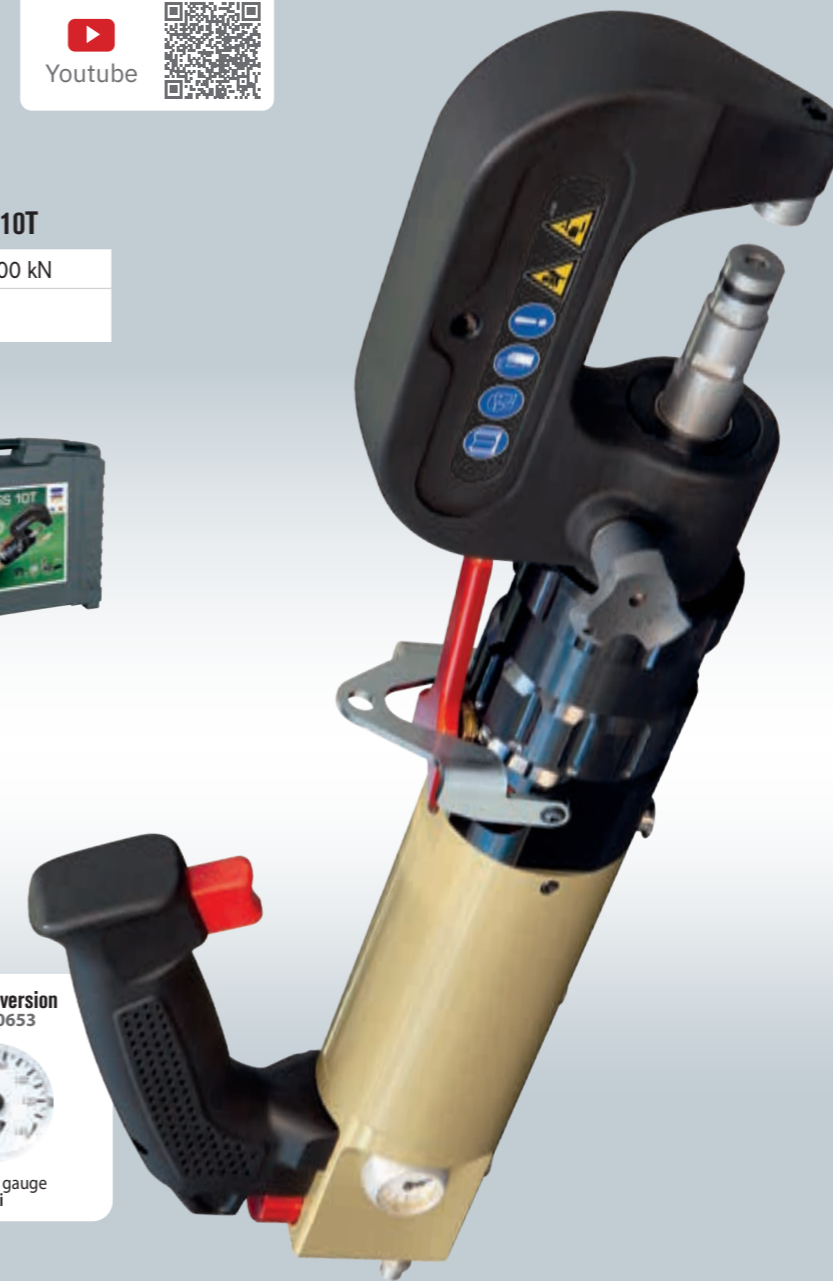

US version 070653



Pressure gauge Psi



Discharge lever  
- Levier de décharge - Auslösehebel



Speed control - Contrôle de la vitesse - Regelung  
Werkzeuggeschwindigkeit



Pressure control  
- Contrôle de la pression - Druckregelung



## GYPRESS 10T COMPLETE PACKS

<b>GYPRESS 10T</b> 063303 070653	✓						
<b>GYPRESS 10T pack 1</b> 066441			✓				
<b>GYPRESS 10T pack 2</b> 082991					✓		
<b>GYPRESS 10T pack 3</b> 064744							✓

MADE IN FRANCE	AIR BAR	PRESSURE CONTROL	SPEED CONTROL			
	cm	kg	LxWxH cm / kg			
<b>GYPRESS 10T</b>	6.5 bar = 10 t (maxi 10 bar)	0 > 6.5 bar	+ -	39.5 x 180	6.2 (HR110 included)	58 x 50 x 15 / 12.1



	HR110	HR210	HR310
	063310	063327	063334
GYSPRESS 8T	✓	✓	—
GYSPRESS 10T	✓	✓	✓
GYSPRESS 8T PUSH PULL	✓	✓	✓
GYSPRESS PREMIUM 10T PUSH PULL	✓	✓	✓
GYSPRESS 10T PUSH PULL	✓	✓	✓
GYSPRESS 10T CONNECT	✓	✓	✓



**KIT WITH HR210 + HR310**  
064089

**CASE & FOAM WITHOUT ARMS**  
- Valise et mousses sans bras  
077546

**XT31-40**  
Rallonges bras HR310 pour point milieu - HR310 arm extension for middle point

Compatible 8T PP/10T/10T PP x2

066335

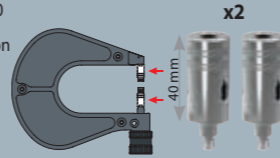

OPTIONS

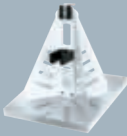

Riveting machine support for changing accessories (arms & dies)  
- Support Riveteuse pour changements d'accessoires (bras & matrice)  
- Supportständer

↓ 28 x 40 x 21,5 cm  
⊗ 45 x 39 x 20 cm / 7,2 kg

054158



Trolley - Chariot

↓ 74 x 51 x 81 cm  
⊗ 80 x 123 x 15 cm / 44 kg

054233

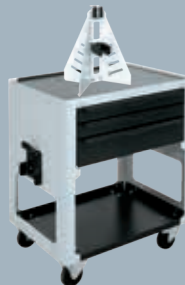

Trolley + Support  
Chariot + Support

↓ 51 x 74 x 122 cm  
⊗ 51,2 kg

055391

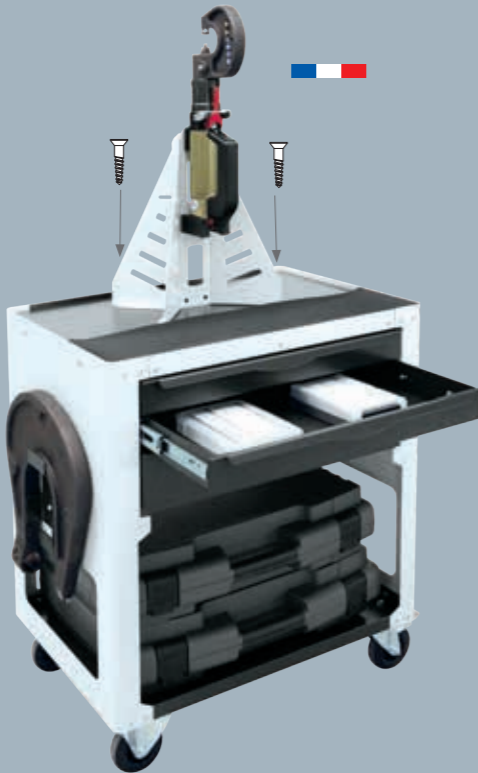

Pressure sensor - Capteur d'effort  
062115



Hydraulic body wrenches (x2)  
067325



Temporary - Serre-tôles - fasteners manual mounting

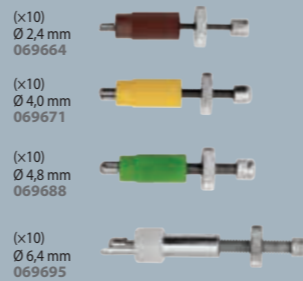

GYPRESS

**PREMIUM**  
PUSH PULL

**GYSPRESS PREMIUM 10T PUSH PULL**

6.5 bar 100 kN

**10t**

077065

070660



UNIQUE **PUSH PULL** SYSTEM by GYS

AUTO or MANUAL



LARGE OPENING

MORE ACCESS

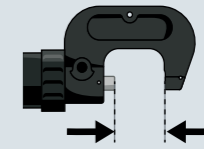

**48.5 mm**  
(no dies)  
23.5 mm with B1/B2 dies

ERGONOMIC WITH QUICK SELECTION

WORK FASTER



Push/Pull selection - Sélection Push/Pull

MANUAL PULL MODE

OPENING CONTROL



Manual/Automatic selection - Sélection Manuel/Automatique



Pressure control - Contrôle de la pression - Druckregelung



Speed control - Contrôle de la vitesse - Régulation Werkzeuggeschwindigkeit

GYSPRESS 10T PREMIUM PUSH PULL COMPLETE PACKS

	HR110 063310	XT11.21 - Extension for HR110 & HR210 058644	Standard 10T tool box 058631	6 x 50 rivets RAP - Nieten SPR 048706	HR210 + HR310 064089	24kN adapter 063822	Trolley+support 055391
<b>GYSPRESS 10T PREMIUM PUSH PULL</b> 077065		✓					
070660							
<b>GYSPRESS 10T PPP pack 1</b> 082519			✓				
<b>GYSPRESS 10T PPP pack 2</b> 082526				✓			
<b>GYSPRESS 10T PPP pack 3</b> 082533					✓		✓

US version  
070660



Pressure gauge  
Psi



UNIQUE 100%  
**No air inclusion**  
maintenance free, no oil refill

MADE IN FRANCE	AIR BAR	PRESSURE CONTROL	SPEED CONTROL	↕	⚖	🧰
				cm	kg	kg
<b>GYSPRESS 10T PREMIUM PUSH PULL</b>	6.5 bar = 10 t (maxi 10 bar)	0 > 6.5 bar	↔	39.5 x 180	6.7 (HR110 included)	59 x 50 x 16 / 13.1



GYPRESS

# SYNERGIC RIVETING WORKSTATION

PNEUMATIC HYDRAULIC



**UNIQUE 100%**  
No air inclusion  
maintenance free, no oil refill

## ACCESSIBILITY

16 languages

- FR PR CN
- GB CZ JP
- DE NL VN
- IT SE FI
- ES RU TR

★★★★  
**SYNERGIC RIVETS SETTINGS**

Main panel

Setup instructions



Results



## 3 MODES

- MANUAL
- SYNERGIC
- CAR MANUFACTURERS

## CAR MANUFACTURERS COMPATIBILITY

- ✓ VW GROUP
- ✓ MERCEDES-BENZ
- ✓ BMW
- ✓ TESLA
- ✓ FERRARI
- ✓ FORD
- ✓ RENAULT ALPINE
- ✓ GM

## CONNECTIVITY

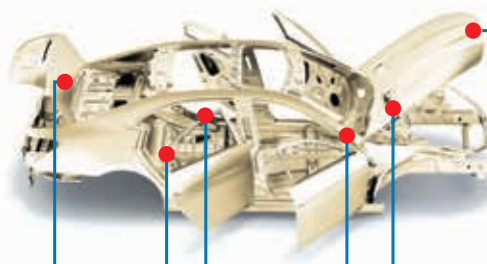

### TRACEABILITY

History data export

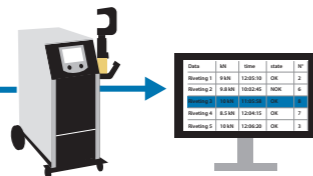

### SOFTWARE UPDATE

Gyspress evolutions

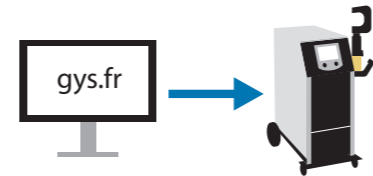

**UNIQUE PUSH PULL SYSTEM by GYS**

### PUSH PULL SYSTEM by GYS

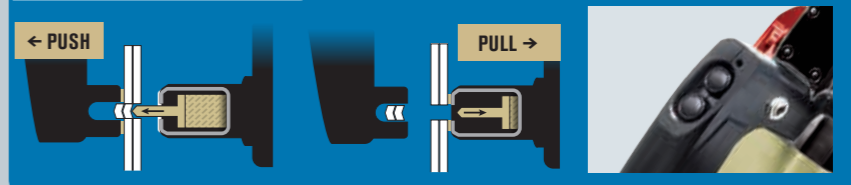

Sélection Push/Pull - Push/Pull selection

Gyspress support



Arms support



REGULATED PRESSURE CONTROL

POWER 10t



Discharge lever - Levier de décharge - Auslösehebel

### WORKSTATION GYPRESS 10T PP CONTROL

6.5 bar 100 kN

**10t**

063860

included



### OPTIONS

Pressure gauge - Capteur d'effort 10T PP CONTROL 071759



Youtube

Hydraulic body wrenches for GYPRESS 10T, 10T PushPull, 10T PP CONTROL (x2) 067325



MADE IN FRANCE <b>WORKSTATION GYPRESS 10T PP CONTROL</b>	230V	AIR BAR 6.5 bar = 10t (maxi 10 bar)	PRESSURE CONTROL 0 > 6.5 bar	SPEED CONTROL + -	LxWxH cm / kg	LxWxH cm / kg
					74 x 50 x 116 / 54	76 x 42 x 94 / 64.4

GYPRESS CONTROL

SYNERGIC RIVETING



# BLIND RIVET ADAPTERS - ADAPTATEURS POUR RIVETS AVEUGLES

GYSPRESS

Adaptators

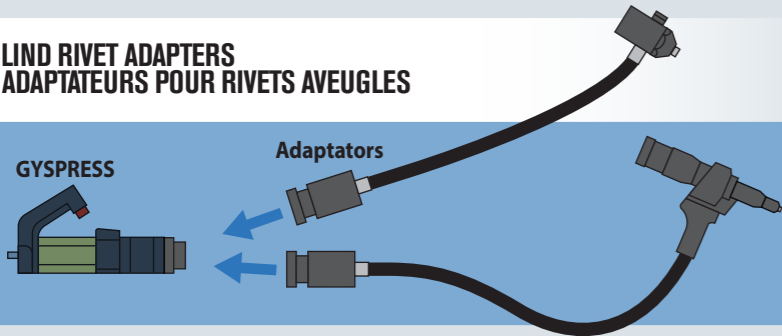

### Compatibility

- GYSPRESS 10T
- GYSPRESS 10T PUSH PULL
- GYSPRESS 10T PUSH PULL PREMIUM
- GYSPRESS 10T CONNECT



Youtube

# BLIND RIVET ADAPTER 24 kN - Adaptateur 24 kn pour rivets aveugles - Blindnietadapter 24 kN

HIGH ACCESSIBILITY



SPECIFIC STORAGE



**24 kN STANDARD** 600 mm  
063822

Pour rivets POP - For BLIND rivets - Für Blindniet  
Acier / Steel: Ø 4.0 → 6.4  
Alu: Ø 4.0 → 7.8

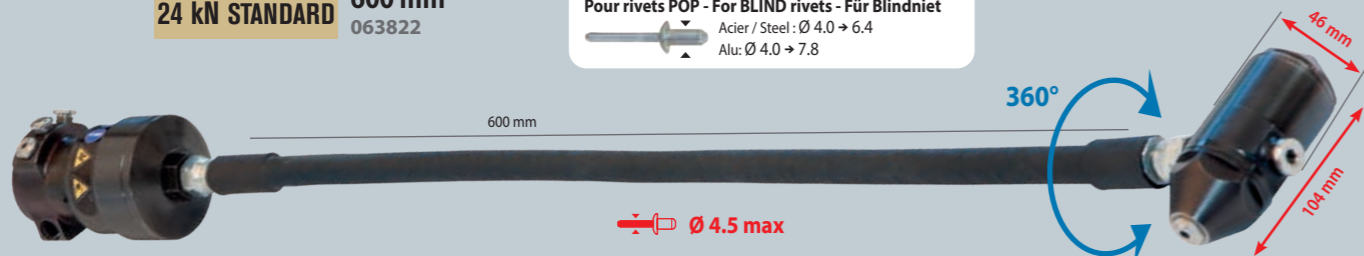

INCLUDED



for standard rivets:

- Ø 3.2 x 1 059221
- Ø 3.6 x 1 059238

- Ø 4.0 x 1 059245
- Ø 4.5 x 1 059252

**24 kN COMPACT** 600 mm  
077164

Pour rivets POP - For BLIND rivets - Für Blindniet  
Acier / Steel: Ø 6.4  
Alu: Ø 6.4 → 7.8

COMPACT HEAD

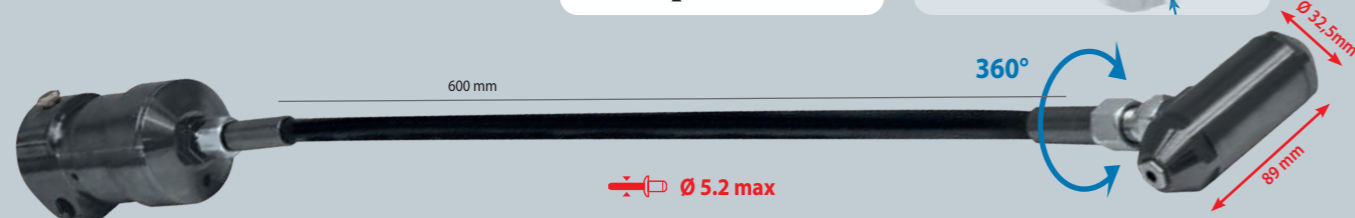

INCLUDED

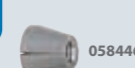

for standard rivets:

- Ø 4.5 x 1 081222
- Ø 5.2 x 1 079939

OPTION

for extraction of self piercing rivet:  
Rivet-extraction insert  
- Buse d'extraction 24kN compact  
Ø 5 079946

# PERFECT COMBO WITH ARCPULL

SPECIAL TEARING RIVETS  
- Spécial arrachage de rivets  
- Spezial-Zugnieten

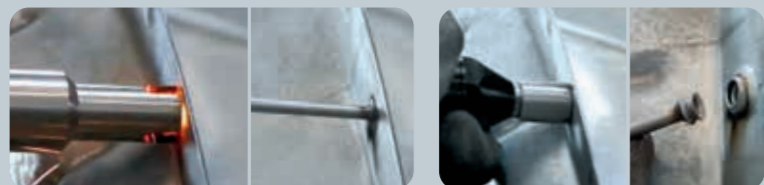
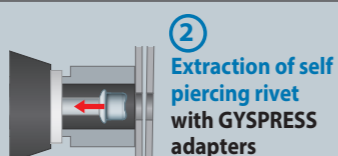
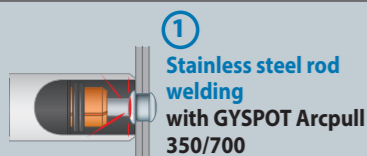

# OPTION FOR GYSPOT ARCPULL (details p.17)

for GYSPOT ARCPULL 350

**ARC PULL RIVET BOX1 350 - 24kN**  
064584

Stainless steel nail - Tige Inox Ø 4 x 50 mm 064607	Barrel for stainless steel nail welding - Canon pour pose de tige inox	Mandrel support Support porte-goujon 059634	Nozzle + pad - Buse + patin 059641	mandrel Ø 4mm 049000	Buse d'extraction 24kN Ø 4 064683
x100	x1	x1	x1	x1	x1

# BLIND RIVET ADAPTER 50 kN - Adaptateur 50 kn pour rivets aveugles - Blindnietadapter 50 kN



50 kN 1 m  
064867  
4.0 kg

Stroke adjustment - Réglage de la course de traction  
0 → 25 mm

For BLIND rivets - Pour rivets POP - Für Blindniet

Steel / Acier: Ø 4.0 → 6.4  
Alu: Ø 4.0 → 7.8

INCLUDED

Kit Standard



Complete kit 065987

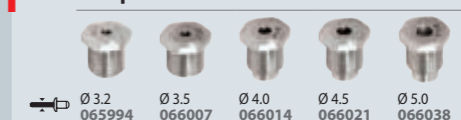

OPTIONS

Steel / Acier: Ø 4.0 → 6.4  
Alu: Ø 4.0 → 7.8

160 mm extension - Extension 160 mm - Verlängerung 160 mm  
066144



Ø 8.0 → 9.8

Ø 8.0/9.8mm nozzle-piece kit - Kit Rivets Ø 8.0/9.8mm - Mundstückkit 8,0/9,8 mm  
066045



M5 → M14  
M5 → M8

Blind rivet nut pulling, Blind rivet bolt adapter kit  
- Kit 6 tirants pour pose d'écrous à sertir et goujons à sertir - Blindnietmuttern, Blindnietgewindebolzen-Kit  
066076



# OPTION FOR GYSPOT ARCPULL (details p.17)

for GYSPOT ARCPULL 350

**ARCPULL RIVET BOX2 350 - 50kN**  
073388

Ø 5 x 50 mm 070745	Long barrel + mandrel M5 - Canon long + mandrin M5 070738	Mandrel support Support porte-goujon 059634	Buse + pad 059641	Buse d'extraction 50kN Ø 5 066151
x100	x1	x1	x1	x1

for GYSPOT ARCPULL 700

**ARCPULL RIVET BOX 700**  
068452

Ø 5 x 50 mm 070745	Long barrel + mandrel M5 - Canon long + mandrin M5 070738	Buse d'extraction 50kN Ø 5 066151	Mandrel support Support porte-goujon 071377	Buse + pad 059641	Ring holder 059610	Rod for pulling rings - Fourche pour anneau 071384	Vis de butée
x100	x1	x1	x1	x1	x2	x1	x1

# CONSUMABLES BOX FOR 50KN ADAPTER - Boîte consommables pour adaptateur 50kN - Zubehörbox für 50 kN Adapter

066168



Blind rivet nuts - Écrous à sertir

M5	M6	M8	M10	M12	M14
0.5 → 3.0	0.5 → 3.0	0.5 → 3.0	1.0 → 3.5	1.0 → 4.0	4.5 → 6.0
x50 066175	x50 066182	x50 066199	x50 066205	x50 066212	x10 066229

Blind rivet bolts - Goujons à sertir

M5	M6	M8
22.5 → 27	24 → 28.5	23.5 → 28
x50 066236	x50 066243	x50 066250

Blind rivets - Rivets aveugles

Ø 6.4	Ø 9.8
2.8 → 4.8	3.0 → 14.0
x50 066267	x50 066274

+ demo metal sheet - plaque de démonstration

+ x10 x10 x10 x10 x10 x5

+ x10 x10 x10

+ x10 x10





**DIES - Matrices - Matrizen**

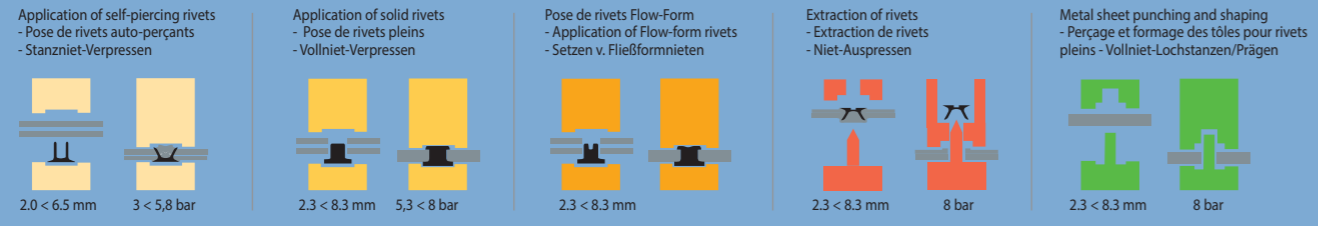

Ø 8																				
A1	A2	B1	B2	B3	B4	B5	B6	D1	D2	D3	D4	D5	D6	D7	D8	D9	D10	D11	D12	D13
055698	055704	055711	055728	055735	059016	059023	059030	055971	055988	055995	055742	056008	056015	056022	056039	056046	055674	056060	056053	055759
A1+A2		B1+B2																		
054295		054301																		

D15	D16	D17	D18	E1		E2	E3	E6	E7	E9	E10	E11	E12	E13	F1	F2	F3	F4	
056077	056084	055681	071155	055865	054288	055766	057005	057142	057159	058606	058613	058620	058828	059085	055773	055780	055797	055803	
				E1+E2												F1+F2			
				054318												054714			

F5	F6	G1	G2	G3	G4	G5	G6	H1	H2	H3	H4	H5	H6	H7	H8	I1	I2	I3	J1	J2
055810	071148	057173	057180	057197	057203	057210	057227	068230	068247	068254	068261	068278	068285	068292	068308	071117	071124	071131	071674	071902

Ø 6													Ø 6		Ø 6		Ø 8		Ø 6.7	
S1	S3	S4	S5	S7	S8	ST1	ST2	ST3	T1	T2	T3	T4	T5	T7	T8	T10	T12	T13		
057036	057043	057050	057067	057074	057081	058071	058088	066397	057098	059078	057104	055827	055834	058019	058033	058040	058064	066373	066380	
													T1+T2							
													054707							

**BREVET GYS / GYS PATENT**  
n° US 11,712,732

Ø 6.7		Ø 6		Ø 8		Ø 10									
T14	T15	T16	T17	T18	T19	T20	T21	T22	T23	T24	T25				
066410	066427	068964	066434	069312	069329	071254	069336	070936	070943	071261	070950	082830	082847	082861	082854

**SELF PIERCING RIVETS (SPR)**  
- Rivets auto-perçants (RAP) - Stanznieten

Steel - Acier - Stahl

Complete box 048706

Ø 3,3 x 3,5 mm x 50	Ø 3,3 x 4 mm x 50	Ø 5,3 x 4 mm x 50	Ø 5,3 x 5 mm x 50	Ø 5,3 x 6 mm x 50	Ø 5,3 x 8 mm x 50	Ø 5,3 x 7 mm	Ø 5,3 x 9 mm
x 200 048232	x 200 048249	x 100 048256	x 100 048263	x 100 048270	x 100 048225	x 100 048638	x 100 048645

**SPECIAL CENTER PUNCH**  
- Pointeau centreur - Spezialekörner

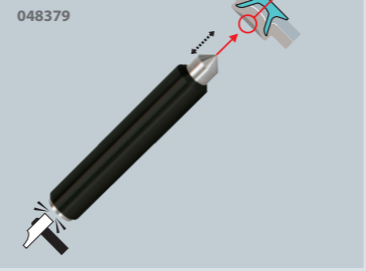

**HYDROPNEUMATIC TOOL FOR BLIND RIVETS**  
- Riveteuse hydro-pneumatique - Hydro-pneum. Blindnietgerät

For BLIND rivets - Pour rivets POP - Für Blindniet  
Ø 4.0 → 7.8

**HR21**

max 21 000 N (6 bar)

055407

MADE IN ITALY

included (x3) 058446

For standard rivets Ø 4.0 51508

For Magnarive rivets Ø 4.5 51507

Option HR21 extension 100 mm 063105

**CORDLESS RIVETER - Riveteuse sur batterie**  
- Akku-Blindnietgerät

For BLIND rivets - Pour rivets POP - Für Blindniet  
Ø 4.0/4.8/5.0/6.0/6.4

**TWO ER20**

max 20 000 N (6 bar)  
10-20 V universal fast charger (30 min)  
2.0 kg

064461

BRUSHLESS motor

2 x 20V/2Ah Li-ion battery

**HYDROPNEUMATIC TOOL FOR BLIND RIVETS** - Riveteuse hydro-pneumatique - Hydro-pneum. Blindnietgerät

For BLIND rivets - Pour rivets POP - Für Blindniet

Steel / Acier Ø 4.0/4.8/6.4  
Alu Ø 4.0/4.8/6.4

**HR14**

max 14 000 N

057241

Made in Taiwan

**MANUAL TOOL FOR BLIND RIVETS**  
- Riveteuse manuelle - Manueller Blindnietgerät

For BLIND rivets - Pour rivets POP - Für Blindniet

Steel / Acier Ø 3.2/4.0/4.8/6.4  
Alu Ø 3.2/4.0/4.8/6.4

**061323**

Made in Taiwan

**HYDROPNEUMATIC TOOL FOR RIVET NUTS** - Sertisseuse hydro-pneumatique riv 998 - Hydro-pneum. Blindnietmuttergerät

Sealing nuts - Ecrous à sertir - Blindnietmuttern

**RIV 998**

For sealing nuts from M3 to M12  
Pour la pose d'écrous à sertir M3 à M12

max 19 000 N (6 bar)  
included accessories for sealing nuts:  
- livré avec accessoires pour écrous à sertir:

- ✓ M3 ✓ M4
- ✓ M5 ✓ M6
- ✓ M8 ✓ M10
- ✓ M12

055414

MADE IN ITALY

**HYDROPNEUMATIC TOOL FOR BLIND RIVETS**  
- Riveteuse hydro-pneumatique - Hydro-pneum. Blindnietgerät

For BLIND rivets - Pour rivets POP - Für Blindniet

Steel / Acier Ø 3.2/4.0/4.8  
Alu Ø 3.2/4.0/4.8

**HR9**

max 9 000 N

057234

Made in Taiwan



# MIG-MAG GMAW-FCAW

## TRADITIONAL

GYS AUTO	84
----------	----

## INVERTER

E GYS AUTO	86
------------	----

AUTOPULSE	88
-----------	----

ACCESSORIES & CONSUMABLES	92
---------------------------	----



# MIG/MAG TRADITIONAL SYNERGIC



15 → 200 A  
Ideal 0,6 mm

### Capacitor

M1GYS AUTO, M3GYS AUTO

> PERFECT WELD

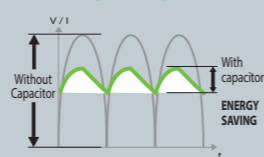

### SYNERGIC - EASY TO USE

Réglage automatique de la vitesse V Auto adaptative wire speed  
Automatische Einstellung der Drahtgeschwindigkeit

#### M1 GYS AUTO

15 → 160 A Capacitor

230V • 1~ 6m

032903

208/240V • 1~ 2m

032088

with accessories

#### T1 GYS AUTO DV

15 → 200 A

400V • 3~ / 230V • 3~

032927

with accessories

#### M3 GYS AUTO

15 → 160 A Capacitor

230V • 1~ 6m

032880

with accessories

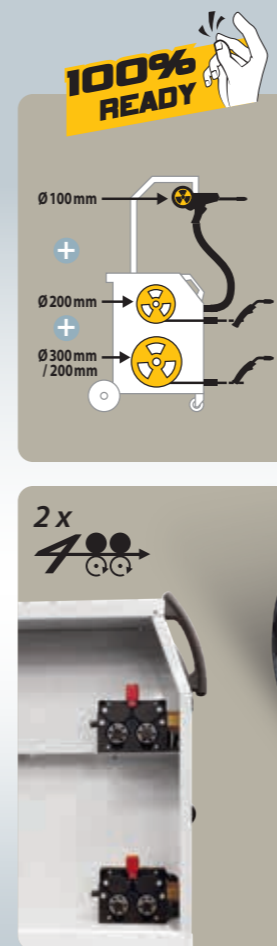

Protection gas  
Argon+CO<sub>2</sub> (Steel, Inox)  
Argon (ALU/CuSi3/CuAl8)  
CO<sub>2</sub>PUR (Steel)

### Spool Gun Torch - Torche motorisée Spool Gun - Spool Gun Brenner



041486

Ideal for  
- Steel / Acier / Stahl  
- Stainless steel / Inox  
- Alu

included 045699

### SPOOL GUN + Support for M3 GYS AUTO

038554



15L/min (FR) 041998  
(UK) 040274  
(NL) 040267  
(IT) 038691

OPTIMAPRO 30L/min (FR) 043619  
(UK) 043626  
(DE) 043633  
(NL) 043640

30L/min (FR) 041622  
(UK) 041646  
(DE) 041219  
(NL) 041615  
(IT) 038707



041332



M3GYS : Protection cover  
- Houuse de protection  
- Schutzhaube

052260

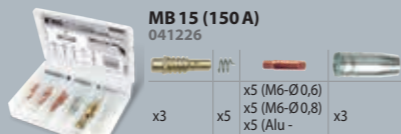

MB 15 (150A)  
041226

x3  
x5  
x5 (M6-Ø0,6)  
x5 (M6-Ø0,8)  
x3 (Alu - M6-Ø0,8)

MADE IN FRANCE	MADE IN CHINA	CE MARK 60974/1	50/60 Hz	A	min → max	Reg	100 (spoolgun) 200 300	Electronic Control	EN60974-1 (40°C)		Ø mm	Original equipment	Protected & compatible power generator (+/-15%)			
									IA (60%)	X% (I2 max)						
			230V 1~						90	140A@15%	0.6+1	0.6/0.8	0.8	78 x 38 x 67 / 56	4,5 kVA	
			208/240V 1~	16	15 → 160	6	option							37 x 79 x 67 / 57.5		
			230V 3~/400V 3~	10	15 → 200	7	option			110	150A@25%	0.6+1	0.6/0.8	0.8	37 x 78 x 67 / 62	5.2 kVA
			230V 1~	16	15 → 160	6				90	140A@15%	0.6+1	0.6/0.8 0.8/1.0	2 x 0.8	74 x 40 x 85 / 77.5	4,5 kVA



E GYS AUTO

# MIG/MAG INVERTER SYNERGIC

Lastest generation  
colour screen 3.5"

### 16 languages

- French
- English
- German
- Italian
- Spanish
- Portuguese
- Czech
- Polish
- Dutch
- Swedish
- Russian
- Chinese
- Japanese
- Vietnamese
- Finnish
- Turkish

### EASY



### EXPERT

Pre-gas / Creep speed / Hotstart /  
Crater filler / Burnback / Post-gas



### EASY TO SETUP



Screen protection -  
Protection d'écran -  
Bildschirmschutz  
079885

### MODES

- MANUEL
- SYNERGIC EASY / EXPERT
- 2T
- 4T
- SPOT
- DELAJ

### FONCTIONS

- TRACEABILITY
- PORTABILITY
- +500 JOBS can be saved

### SYNERGIES

- STEEL
- AlSi
- AlMg
- Cu Si 3 / CuAl 8
- CrNi

### UPDATES

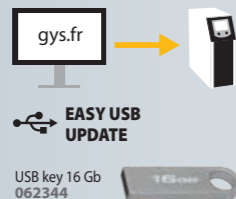

EASY USB  
UPDATE

USB key 16 Gb  
062344

### E1 GYS AUTO

10 **200 A** 230V 1~ PFC

with accessories :

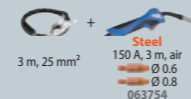

075122

### E2 GYS AUTO

10 **200 A** 230V 1~ PFC

with accessories :

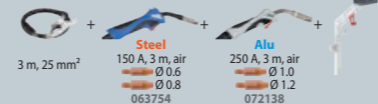

075139

### E3 GYS AUTO

10 **200 A** 230V 1~ PFC

with accessories :

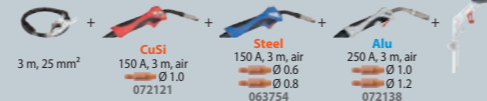

075160



4 m³  
(20L)

1 x

6 m

E1 GYS AUTO 200 A • × 1



2 x 4 m³  
(20L)

2 x

6 m

E2 GYS AUTO 200 A • × 2

2 x 4 m³  
(20L)

3 x

6 m

E3 GYS AUTO 200 A • × 3



### PFC POWER FACTOR CORRECTION

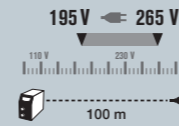

MADE IN FRANCE	CE NORM. 60974/1	50/60 Hz	A	6 m	min → max A	Ø mm		Electronic Control	EN60974-1 (40°C)		Original equipment Equipement d'origine Originalausstattung Equipamiento de fabrica	LxWxH cm / kg	Protected & compatible power generator (+/-15%)
						200	300		IA (60%)	X% (I2 max)			
▪	E1 GYS AUTO	230V 1~	16	6 m	10 → 200	▪	▪		145	20	Acier Type B 0.6/0.8	79 x 37 67 / 42.6	9KVA
▪	E2 GYS AUTO	230V 1~	16	6 m	10 → 200	▪	▪		145	20	Acier Type B 0.6/0.8 Alu Type B 0.8/1	72 x 37 x 105 / 59.5	9KVA
▪	E3 GYS AUTO	230V 1~	16	6 m	10 → 200	▪	▪		145	20	Acier Type B 0.6/0.8 Acier Type B 0.8/1 Alu Type B 0.8/1	73 x 38 x 108 / 64	9KVA

E GYS AUTO

SYNERGIC MIG  
GMAW  
FGAW



# MIG/MAG INVERTER DOUBLE PULSE

Latest generation  
colour screen 5"  
800 x 480 (WVGA)



Youtube

## ACCESSIBILITY

3 interface levels

- EASY
- EXPERT
- ADVANCED

16 languages

- French
- English
- German
- Italian
- Spanish
- Portuguese
- Czech
- Polish
- Dutch
- Swedish
- Russian
- Chinese
- Japanese
- Vietnamese
- Finnish
- Turkish

EASY



3 INTERFACE LEVELS

ADVANCED  
Arc length adjustments



EXPERT

Pre-gas / Hot Start / Upslope / Downslope /  
Crater filler / Post-gas



500+ JOBS can be saved



TRACEABILITY



PORTABILITY



MODES

- DYNAMIC STANDARD
- PULSE
- PULSE IN PULSE
- MANUAL
- COLD PULSE

FULLY DIGITAL

4 MICROPROCESSORS



65+ SYNERGIES

Find all the synergies:  
Retrouvez toutes les synergies :  
Finde alle Synergien :



STEEL

Cu Si 3 / Cu Al 8

ALU

UPDATES

EASY USB UPDATE

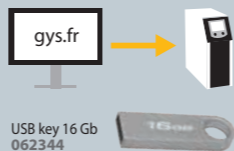

USB key 16 Gb  
062344

OPTIONS

PUSH PULL TORCH 24 V



Motor inside



- x5 (M6-0.5)
- x5 (M6-0.8)
- x5 (M6-1.0)
- x5 (Alu-M6-0.10)
- x5 (Alu-M6-0.12)



Torch gas flow-meter  
- Débitmètre de  
bout de torche

053939



Protection cover  
- Housses de protection  
- Schutzhaube  
052260



AUTOPULSE 220-M1

- 1 Ø 200 / 300
- PP

AUTOPULSE 220-M2

- 1 Ø 200 / 300
- PP
- 2 Ø 200 / 300

AUTOPULSE 220-M1

10 220 A 230V 1~ PFC

with accessories:

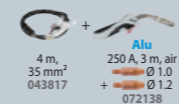

065024

AUTOPULSE 220-M1 208-240V

10 220 A 208>240V 1~ PFC

with accessories:

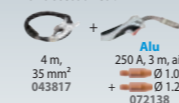

070868



PFC POWER FACTOR CORRECTION

185 V ← 265 V

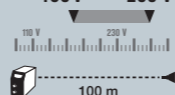

220 A • x 1



AUTOPULSE 220-M2

10 220 A 230V 1~ PFC

with accessories:

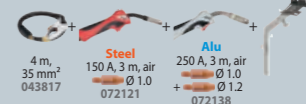

069855

AUTOPULSE 220-M2 208-240V

10 220 A 208>240V 1~ PFC

with accessories:



069862



220 A • x 2

MADE IN FRANCE	50 / 60 Hz	A	Ø mm	A	SPOOLGUN	PUSH/PULL	200 / 300	Cooling system	Original equipment Equipment d'origine Originalausstattung Equipamiento de fabrica	EN60974-1 (40°C)	IA (60%)	X% (12 max)	LxWxH cm / kg	Protected & compatible power generator (+/-15%)
AUTOPULSE 220-M1	230 V · 1~	8 m	16	0.6+1.2	10+220	OPTION	■ ■	Air	ALU : Type B 1.0 / 1.2	150	220 A @ 20%	75 x 41 x 94 / 65.5	10 kVA	
AUTOPULSE 220-M1 208-240V	208 > 240 V · 1~	8 m	16	0.6+1.2	10+220	OPTION	■ ■	Air	ALU : Type B 1.0 / 1.2	150	220 A @ 20%	75 x 41 x 94 / 62.6	10 kVA	
AUTOPULSE 220-M2	230 V · 1~	8 m	16	0.6+1.2	10+220	OPTION	■ ■	Air	ACIER : Type B 0.8 / 1.0 mm ALU : Type B 1.0 / 1.2	150	220 A @ 20%	74 x 41 x 93 / 78.8	10 kVA	
AUTOPULSE 220-M2 208-240V	208 > 240 V · 1~	8 m	16	0.6+1.2	10+220	OPTION	■ ■	Air	ACIER : Type B 0.8 / 1.0 mm ALU : Type B 1.0 / 1.2	150	220 A @ 20%	74 x 40 x 93 / 79.8	10 kVA	



# MIG/MAG INVERTER DOUBLE PULSE

BODYSHOP SPECIFIC  
**COLD PULSE**  
CuSi3 Ø 0.8/1



Helmet not included

2 x 4 m<sup>3</sup>  
(20L)

3 x

8 m

PFC POWER FACTOR CORRECTION

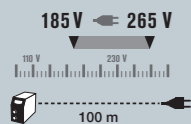

**AUTOPULSE 220-M3**

1				PP
2				
3				

LIC ELECTRONIC

**AUTOPULSE 220-M3** 10 **220 A** 230V 1~ PFC

with accessories:  
4 m, 35 mm<sup>2</sup> 043817 + CuSi 150 A, 3 m, air Ø 1.0 072121 + Steel 150 A, 3 m, air Ø 0.8 063754 + Alu 250 A, 3 m, air Ø 1.0 Ø 1.2 072138

**AUTOPULSE 220-M3 208-240V** 10 **220 A** 208>240V 1~ PFC

with accessories:  
4 m, 35 mm<sup>2</sup> 043817 + CuSi 150 A, 3 m, air Ø 1.0 072121 + Steel 150 A, 3 m, air Ø 0.8 063754 + Alu 250 A, 3 m, air Ø 1.0 Ø 1.2 072138

### OPTIONS

#### PUSH PULL TORCH 24 V



MB 25 4m 046283  
Torch gas flow-meter - Débitmètre de bout de torche 053939

MB 15 / MB 25 (250 A) 077089  
Protection cover - Housse de protection - Schutzhaube 052260  
x5 (Mg-Ø 0.6)  
x5 (Mg-Ø 0.8)  
x5 (Mg-Ø 1.0)  
x5 (Mg-Ø 0.8)  
x5 (Mg-Ø 1.0)  
x5 (Alu - Mg-Ø 1.0)  
x5 (Alu - Mg-Ø 1.2)

**AUTOPULSE 320-T1** **AUTOPULSE 320-T3** **AUTOPULSE 320-T3 208-240V**

1				PP
2				
3				

LIC ELECTRONIC

**AUTOPULSE 320-T1** 15 **320 A** 400V 3~

with accessories:  
4 m, 35 mm<sup>2</sup> 043817 + Alu 250 A, 3 m, air Ø 1.0 Ø 1.2 072138

069831

**AUTOPULSE 320-T3** 15 **320 A** 400V 3~

with accessories:  
4 m, 35 mm<sup>2</sup> 043817 + Steel 250 A, 3 m, air Ø 1.0 072152 + Steel 250 A, 3 m, air Ø 0.8 072145 + Alu 250 A, 3 m, air Ø 1.0 Ø 1.2 072138

067615

**AUTOPULSE 320-T3 208-240V** 15 **320 A** 208>240V 3~ PFC

with accessories:  
4 m, 35 mm<sup>2</sup> 043817 + Steel 250 A, 3 m, air Ø 1.0 072152 + Steel 250 A, 3 m, air Ø 0.8 072145 + Alu 250 A, 3 m, air Ø 1.0 Ø 1.2 072138

036970



10 m<sup>3</sup>  
(50L)

1 x

5 m

3 x

### OPTIONS

for AUTOPULSE 320-T3 (400V) only

#### SPOOLGUN TORCH

#### Ideal Alu



Ø 0,8  
4m 041486  
Motor inside

220 A • x 3

320 A • x 1

320 A • x 3

MADE IN FRANCE EN60974-1	50 / 60 Hz	A	Ø mm	min → max	SPOOLGUN	PUSH/PULL	200	Cooling system	Equipement d'origine Original equipment Originalausstattung Equipamiento de fabrica		EN60974-1 (40°C)		LxWxH cm / kg	Protected & compatible power generator (+/-15%)
									ELECTRONIC CONTROL	IA (60%)	X% (I2 max)			
<b>AUTOPULSE 220-M3</b>	230 V · 1~	8 m	16	0.6+1.2	10+220	OPTION	Air		ACIER : Type B 0.6 / 0.8 ACIER : Type B 0.8 / 1.0 ALU : Type B 1.0 / 1.2	150	220 A @ 20%	75 x 41 x 94 / 80	10 kVA	
<b>AUTOPULSE 220-M3 208-240V</b>	208>240 V · 1~	8 m	16	0.6+1.2	10+220	OPTION	Air		ACIER : Type B 0.6 / 0.8 ACIER : Type B 0.8 / 1.0 ALU : Type B 1.0 / 1.2	150	220 A @ 20%	75 x 41 x 94 / 80	10 kVA	

MADE IN FRANCE EN60974-1	50 / 60 Hz	A	Ø mm	min → max	SPOOLGUN	PUSH/PULL	200 / 300	Cooling system	Original equipment Equipement d'origine Originalausstattung Equipamiento de fabrica		EN60974-1 (40°C)		LxWxH cm / kg	Protected & compatible power generator (+/-15%)
									ELECTRONIC CONTROL	IA (60%)	X% (I2 max)			
<b>AUTOPULSE 320-T1</b>	400 V · 3~	5 m	16	0.6+1.2	15+320	OPTION	Air		ALU : Type B 1.0 / 1.2	260	320 A @ 35%	74 x 41 x 94 / 65.1	16 kVA	
<b>AUTOPULSE 320-T3</b>	400 V · 3~	5 m	16	0.6+1.2	15+320	OPTION	Air		ACIER : Type C 0.8 / 1.0 mm ALU : Type C 1.0 / 1.2	260	320 A @ 35%	75 x 40 x 94 / 82	16 kVA	
<b>AUTOPULSE 320-T3 208-240V</b>	208-240 V · 3~	5 m	25	0.6+1.2	15+320	OPTION	Air		ACIER : Type C 0.8 / 1.0 mm ALU : Type C 1.0 / 1.2	260	320 A @ 35%	74 x 41 x 95 / 82	16 kVA	

# MANUAL TORCHES

- Torches manuelles - Brenner  
- Antorcha - Lastoort - Tocha

### CLASSIC



### CLASSIC

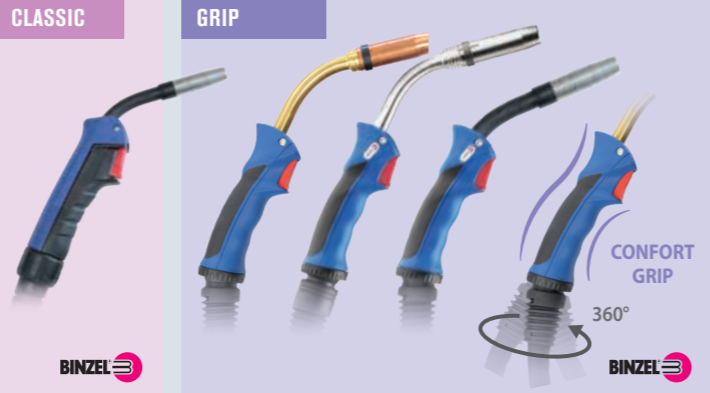

### FUME EXTRACTION

Fume Extraction Torches - Torches aspirantes - Rauchgas-Absaugbrenner - Antorcha con aspiración de humos



Complete systems (p. 121)

### PUSH PULL

for AUTOPULSE



### SPOOL GUN

Special CAR BODY REPAIR MACHINES



### COMPLETE TORCHES

X % 40°C, ArCo <sub>2</sub>	Steel/Stainless steel - Acier / Inox - Stahl/Edelstahl						ALU - Aluminium - Aluminio					PUSH PULL	SPOOL GUN
	AIR			LIQUID			AIR			LIQUID		AIR	AIR
	150 A	150 A	250 A	250 A	350 A	300 A	150 A	250 A	250 A	350 A	300 A	220 A	150 A
M6 Ø0.8	M6 Ø1.0	M6 Ø0.8	M6 Ø1.0	M8 Ø1.2	M6 Ø1.2	M6 Ø0.8	M6 Ø1.0	M6 Ø1.2	M8 Ø1.2	M6 Ø1.2	M6 Ø1.2	M6 Ø1.2	M6 Ø0.8
3 m	3 m	3 m	3 m	4 m	3 m	3 m	3 m	3 m	3 m	3 m	4 m	4 m	
063754	072121	072145	072152	063792	040694	063761	063785	072138	063808	040748	046283	041486	
3 m			4 m	3 m	4 m	3 m	3 m			3 m	4 m		
Flexible 063754			063778	040687	043275	041462	040724			Carbon liner 040731	043282		
3 m			3 m	4 m			4 m			4 m			
041424			040700	040946			040939			Carbon liner 040953			
3 m			4 m	4 m									
043268			040922	040557									
3 m			3 m										
043251			040540										

### Anti-spatter spray (without silicone)

- Spray protecteur sans silicone - Antihafspray (Ohne Silicon)

041806

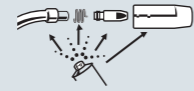

### MIG torch stand with magnetic base

- Support torche magnétique

041653



# CONSUMABLES - Consommables

Gas nozzles - Buses - Düsen - Tubo - Nippel - Bicos

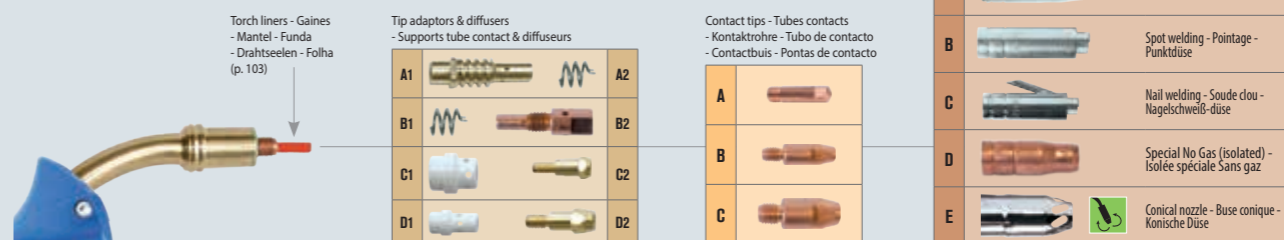

### Tip adaptors & diffusers - Supports tube contact & diffuseurs

	Steel/Stainless steel - Acier / Inox - Stahl/Edelstahl				ALU - Aluminium - Aluminio				PUSH PULL		SPOOL GUN
	AIR		LIQUID		AIR		LIQUID		AIR		AIR
	150 A	250 A	350 A	300 A	150 A	250 A	350 A	300 A	150 A	250 A	150 A
A1 (x5)	B1 (x5)	D1 (x3)	C1 (x3)	A1 (x5)	B1 (x5)	D1 (x3)	C1 (x3)	A1 (x5)	B1 (x5)	A1 (x5)	
042902	042995	043008	043589	042902	042995	043008	043589	042902	042995	042902	
A2 (x10)	B2 (x5)	D2 (x5)	C2 (x5)	A2 (x10)	B2 (x5)	D2 (x5)	C2 (x5)	A2 (x10)	B2 (x5)	A2 (x10)	
042988	042919	042926	043541	042988	042919	042926	043541	042988	042919	042988	

### Contact tips - Tubes contacts - Kontaktröhre - Tubo de contacto - Contactbus - Pontas de contacto

	150 A	250 A	350 A	300 A	150 A	250 A	350 A	300 A	150 A	250 A	150 A
Ø0.6	A (x10) 041905	A (x10) 041905	—	A (x10) 041905	—	—	—	—	—	—	—
Ø0.8	A (x10) 041912	B (x10) 041950	C (x10) 041790	B (x10) 041950	B (x10) 041059	A (x10) 041059	—	B (x10) 041059	B (x10) 041059	B (x10) 041059	B (x10) 041059
Ø1.0	A (x10) 041929	B (x10) 041967	C (x10) 419803	B (x10) 041967	B (x10) 041066	B (x10) 041066	C (x10) 419766	B (x10) 041066	B (x10) 041066	B (x10) 041066	B (x10) 041066
Ø1.2	A (x10) 040144	B (x10) 041974	C (x10) 419810	B (x10) 041974	B (x10) 041073	B (x10) 041073	C (x10) 419773	B (x10) 041073	B (x10) 041073	B (x10) 041073	B (x10) 041073
Ø1.4	—	—	C (x10) 419827	—	—	—	—	—	—	—	—
Ø1.6	—	—	C (x10) 419834	—	—	—	C (x10) 041080	—	—	—	—
Ø2.4	—	—	C (x10) 040533	—	—	—	—	—	—	—	—

### Gas nozzles - Buses - Düsen - Tubo - Nippel - Bicos

	150 A	250 A	350 A	300 A	150 A	250 A	350 A	300 A	150 A	250 A	150 A		
A	53 mm Ø12 (x3) 041875	57 mm Ø15 (x3) 041882	84 mm Ø16 (x3) 041783	63.5 mm Ø12 (x3) 043534	53 mm Ø12 (x3) 041875	53 mm Ø16 (x3) 046214	57 mm Ø15 (x3) 041882	84 mm Ø16 (x3) 041783	63.5 mm Ø12 (x3) 043534	63.5 mm Ø17 (x3) 046221	53 mm Ø12 (x3) 041875	57 mm Ø15 (x3) 041882	53 mm Ø12 (x3) 041875
B	53 mm (x1) 041851	—	—	—	—	—	—	—	—	—	—	—	—
C	53 mm (x1) 041523	—	—	—	—	—	—	—	—	—	—	—	—
D	(x1) 041868	—	—	—	—	—	—	—	—	—	—	—	—
E	(x1) 043084	(x1) 040571	(x1) 040588	—	—	—	—	—	—	—	—	—	—

### Boxes

- Coffrets - Verschleißteilebox - Cajas - Kistjes - Estojos



M6 - Ø0.6 x5	M6 - Ø0.8 x5	Alu - M6 - Ø0.8 x5	M6 - Ø0.8 x5	M6 - Ø1.0 x5	Alu - M6 - Ø1.0 x5	M6 - Ø0.8 x5	M6 - Ø1.0 x5	Alu - M6 - Ø1.0 x5	M6 - Ø1.0 x5	M6 - Ø1.2 x5	Alu - M6 - Ø1.0 x5	Alu - M6 - Ø1.2 x5	MB 15 (150 A) 041226
M6 - Ø0.6 x5	M6 - Ø0.8 x5	Alu - M6 - Ø1.0 x5	M6 - Ø0.8 x5	M6 - Ø1.0 x5	Alu - M6 - Ø1.2 x5	—	—	—	—	—	—	—	MB 15 / MB 25 077089
M6 - Ø1.0 x5	M6 - Ø1.0 x5	Alu - M6 - Ø1.0 x5	M6 - Ø1.0 x5	M6 - Ø1.0 x5	Alu - M6 - Ø1.0 x5	M6 - Ø0.8 x5	M6 - Ø1.0 x5	Alu - M6 - Ø1.0 x5	M6 - Ø1.0 x5	M6 - Ø1.2 x5	Alu - M6 - Ø1.0 x5	Alu - M6 - Ø1.2 x5	MB 25 (250 A) 041233
M6 - Ø1.0 x5	M6 - Ø1.2 x5	Alu - M6 - Ø1.0 x5	M6 - Ø1.0 x5	M6 - Ø1.2 x5	Alu - M6 - Ø1.2 x5	M6 - Ø0.8 x5	M6 - Ø1.0 x5	Alu - M6 - Ø1.0 x5	M6 - Ø1.0 x5	M6 - Ø1.2 x5	Alu - M6 - Ø1.0 x5	Alu - M6 - Ø1.2 x5	MB 36 (350 A) 041417

ACCESSORIES & CONSUMABLES







# PLASMA CUTTING

EASYCUT	98
CUTTER	99





# INDUCTION HEATING

1 200 - 22 000 kW

**GYSDUCTION** 102

**COMBIDUCTION** 103

**POWERDUCTION** 104

**ACCESSORIES & CONSUMABLES** 108



# INDUCTION HEATING

CAR BODY

PFC POWER FACTOR CORRECTION

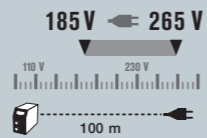

Youtube



	PACKS - GYSDUCTION AUTO									
	PROLINER AUTO 048775	COMPLETE AUTO 053380	COMPLETE AUTO+ 056978	MECA AUTO 048812	MECA AUTO+ 056961	BODY SHOP AUTO 048799	GLASS AUTO 048805	DENT REPAIR AUTO 054981	SMART REPAIR AUTO 079847	
GYSDUCTION AUTO	✓	✓	✓	✓	✓	✓	✓	✓	✓	✓
Plastic wedges 051294	✓	✓	✓	-	-	✓	✓	-	✓	
Burn off inductor 053373	✓	✓	✓	-	-	✓	✓	-	✓	
Body Inductor 053359	✓	✓	✓	-	-	✓	1 box	-	✓	
Bolt Inductor 053366	✓	✓	✓	✓	✓	-	-	-	-	
Remote control 055490	✓	✓	✓	✓	✓	✓	-	✓	-	
Universal 800 051331	✓	1 box	-	1 box	-	-	-	-	-	
Cable support 052284	✓	-	-	-	-	-	-	-	-	
Dent pulling Inductor 054776	3 boxes	-	-	-	-	✓	✓	-	-	
Spiral inductor 054783		✓		✓		1 box	1 box	✓	1 box	



**GYSDUCTION AUTO**  
**2 400 W** 230 V • 1~  
 PFC AIR

CONSUMABLES



Protection (x5)  
+ Colle - Stick  
053854



Protection (x1)  
+ Colle - Stick  
059108



Protection (x10)  
+ Colle - Stick  
053847



**COMBIDUCTION AUTO 50LG**  
**5 200 W** 230 V • 1~  
 PFC LIQUID  
 065901



**INCLUDED COMBIDUCTION**

Glass - Décapage - Entfernen  
053373

Decal - Décollage - Entkleben  
053359

**OPTIONS**

Spiral inductor - Inducteur spirale - Spiralinduktor  
054783

2.5 m 1.2 kW

800 mm 054813      800 mm 054868

<b>SIDE</b>	Ø 18 mm	⊙ ≤ M8	054806
	Ø 24 mm	⊙ ≤ M12	054790
	Ø 30 mm	⊙ ≤ M16	055469

Complete with - Completez avec - Vervollständigen mit :

<b>SIDE</b>	Ø 21 mm	⊙ ≤ M10	079953
	Ø 27 mm	⊙ ≤ M14	079960
<b>FRONT</b>	Ø 18 mm	⊙ ≤ M8	079977
	Ø 21 mm	⊙ ≤ M10	079984
	Ø 24 mm	⊙ ≤ M12	079991
	Ø 27 mm	⊙ ≤ M14	080003
	Ø 30 mm	⊙ ≤ M16	080010

PDR : Paintless Dent Repair  
- Débosselage sans peinture  
- Lackschadenfreies Ausbeulen  
054776

Licensed by BETAG innovation

3 m

Freezer spray - Spray refroidisseur  
-50 °C  
400 ml  
(x 12)  
048898

Adhesive for logo (x10)  
051492

Adhesive

EN-60335/1	MADE IN FRANCE	A	W	kHz	Tech.	PFC	Liquid Cooling	Cable L (m)		Heating			LxWxH cm / kg	LxWxH cm / kg	Protected & compatible power generator (+/-15%)
								Inductor	Inductor	Heating	Heating	Heating			
<b>GYSDUCTION AUTO</b>		230V, 1~, 50/60 Hz	16 mini	2400	35+100	■	—	2	2.5	M10 → 1 s	2 mm → 5 s	Ø8 → 10 s	37 x 21 x 37 / 7.5	52 x 30 x 37 / 12.9	3 kW
<b>COMBIDUCTION AUTO 50LG</b>		230V, 1~, 50/60 Hz	25 mini	5200	20+80	■	■ 71	8	3	M14 → 1 s	2 mm → 3 s 4 mm → 5 s	Ø10 → 10 s	46 x 43 x 75 / 60	v	6 kW



# INDUCTION HEATING

# 1.2 → 5.2 kW

MAINTENANCE / MECHANIC / INDUSTRY

	10R	10R PRO
POWERDUCTION 10R	✓	✓
Flexible 800 mm   054813	✓	✓
Straight 800 mm   054868	✓	✓
<b>SIDE</b>		
Ø 18 mm ⊙ ≤ M8   054806	✓	✓
Ø 21 mm ⊙ ≤ M10   079953	✓	✓
Ø 24 mm ⊙ ≤ M12   054790	✓	✓
Ø 27 mm ⊙ ≤ M14   079960	✓	✓
Ø 30 mm ⊙ ≤ M16   055469	✓	✓
<b>FRONT</b>		
Ø 18 mm ⊙ ≤ M8   079977	✓	✓
Ø 21 mm ⊙ ≤ M10   079984	✓	✓
Ø 24 mm ⊙ ≤ M12   079991	✓	✓
Ø 27 mm ⊙ ≤ M14   080003	✓	✓
Ø 30 mm ⊙ ≤ M16   080010	✓	✓



PFC POWER FACTOR CORRECTION

185 V ← 265 V

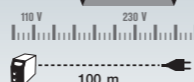

	included	39LG C20/B1	39LG S90
C20/B1   056862	✓	✓	—
285   064485	—	—	✓
S90   058927	—	—	✓



1200 W | 230V • 1~ | AIR

**POWERDUCTION 10R**  
(5 inductors)  
062504  
068643  
080966 **NEW**

**POWERDUCTION 10R PRO**  
(12 inductors)  
080195  
080300

POWERDUCTION 37LG

**3700 W** | 230V • 1~  
**\* LIQUID**  
056992  
072510  
080959 **NEW**

POWERDUCTION 39LG (C20/B1) | POWERDUCTION 39LG (S90)

**3700 W** | 230V • 1~  
**PFC \* LIQUID**  
058583 | 080027

POWERDUCTION 50LG

**5200 W** | 230V • 1~  
**PFC \* LIQUID**  
055599

**OPTIONS 10R**

Decal - Décollage - Entkleben | 066601

Loosening - Dégrippage - Lockerung | 079472

BS | 079489

**OPTION 37LG**

Cable hanger - Cable support | 052284

**Trolley - Chariot UNIVERSAL 800** | 051331

**OPTION 50LG**

Protection cover - Housses de protection - Schutzhaube | 062733

MADE IN FRANCE	Cable L (m)	Heating		Protected & compatible power generator (+/-15%)	L × W × H cm / kg	L × W × H cm / kg
		Inductor	Heating			
<b>POWERDUCTION 10R / 10R PRO</b>	230V, 1~ / 50/60 Hz	10 mini	1200 45 → 80	—	062504 - 42 × 17 × 37 / 5.4 080195 - NF	062504 - 21 × 10 × 15 / 3.3 080195 - NC
<b>POWERDUCTION 37LG</b>	230V, 1~ / 50/60 Hz	16 mini	3700 15 → 30	1.51	60 × 34 × 33 / 14.5	56 × 26 × 29 / 13
<b>POWERDUCTION 39LG (C20/B1) / (S90)</b>	230V, 1~ / 50/60 Hz	16 mini	3700 20 → 60	71	058583 - 81 × 38 × 59 / 52 080027 - NF	058583 - 46 × 36 × 70 / 46.5 080027 - NC
<b>POWERDUCTION 50LG</b>	230V, 1~ / 50/60 Hz	25 mini	5200 20 → 60	71	80 × 60 × 60 / 71	46 × 43 × 75 / 58



# INDUCTION HEATING 11 → 22 kW



included adapter  
32L + L90  
064515 + 059788

4 m

included  
removable  
handle  
068599



**400V**  
included adapter  
32L + L90  
064515 + 059788

**208-240V**  
included adapter  
32L + B4  
064515 + 067882

6 m

included  
removable  
handle  
068599



included adapter  
32L + L20/B4  
064515 + 067882

6 m  
or  
10 m

included  
removable  
handle  
068599

POWERDUCTION 110LG

11 000 W 400V • 3~

LIQUID

058590

POWERDUCTION 110LG 208-240V

11 000 W 208-240V • 3~

LIQUID

065246

POWERDUCTION 160LG

16 000 W 400V • 3~

LIQUID

057814

POWERDUCTION 160LG 208-240 V

16 000 W 208-240V • 3~

LIQUID

065253

POWERDUCTION 220LG

22 000 W 400V • 3~

LIQUID

6 m cable :  
066861

10 m cable :  
074576

## OPTIONS



Removable handle  
- Poignée de lance  
- Abnehmbarer Griff  
for POWERDUCTION  
110 - 160 - 220 LG  
068599



Cooling liquid  
for  
POWERDUCTION

2 L 082212  
5 L 062511  
10 L 052246



Protection cover  
- Housse de protection  
- Schutzhaube  
for  
POWERDUCTION  
160 - 220 LG  
050853



Protection cover  
- Housse de protection  
- Schutzhaube  
for  
POWERDUCTION  
110LG  
062733



055490

## OPTION

Powerduction  
160/220 LG over  
hanging arm-  
pulley  
- Équilibrer  
Powerduction  
160/220 LG

079441



## t° POWER HEAT CONTROLLER

t° CONTROL  
80>350°C (210>660°F)



5,5m

POWER HEAT  
CONTROLLER  
061644

Included  
T° sensors  
thermocouple type K  
x2

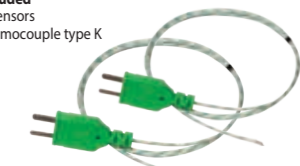

Compatibility  
POWERDUCTION 110LG  
POWERDUCTION 110LG 208-240 V  
POWERDUCTION 160LG  
POWERDUCTION 160LG 208-240 V  
POWERDUCTION 220LG

## OPTION



Pyrometer IR  
for inductor L90

1.1 m  
064119

MADE IN FRANCE	Cable L (m)	+AM+	Freq.	Liquid Cooling	Cable L (m)		Heating	LxWxH cm / kg	LxWxH cm / kg	Protected & compatible power generator (+/-15%)			
					Inductor	Inductor							
POWERDUCTION 110LG	400V, 3~, 50/60 Hz	16 mini	11 000	20+60	71	5	4	M18 → 1 s	2 mm → 2 s 4 mm → 4 s	Ø10 → 7 s	42 x 42 x 76 / 66.5	59 x 80 x 60 / 86	15 kW
POWERDUCTION 110LG 208-240V	208-240V, 3~, 50/60 Hz	35 mini	11 000	20+60	71	5	4	M18 → 1 s	2 mm → 2 s 4 mm → 4 s	Ø10 → 7 s	42 x 42 x 76 / 78	59 x 80 x 60 / 90	15 kW
POWERDUCTION 160LG	400V, 3~, 50/60 Hz	32 mini	16 000	20+60	301	4	6	M20 → 1 s	2 mm → 2 s 4 mm → 4 s	Ø10 → 5 s	78 x 58 x 118 / 128	80 x 61 x 120 / 140	22 kW
POWERDUCTION 160LG 208-240V	208-240V, 3~, 50/60 Hz	45 mini	16 000	20+60	301	4	6	M20 → 1 s	2 mm → 2 s 4 mm → 4 s	Ø10 → 5 s	78 x 58 x 118 / 113.5	80 x 60 x 120 / 126	22 kW
POWERDUCTION 220LG	400V, 3~, 50/60 Hz	32 mini	22 000	20+60	301	4	6	M45 → 3 s	4 mm → 3 s 8 mm → 9 s	Ø10 → 4 s	70 x 60 x 120 / 98	80 x 60 x 132 / 139	22 kW
POWERDUCTION 220LG 10M	400V, 3~, 50/60 Hz	32 mini	22 000	20+60	301	4	10	M45 → 3 s	8 mm → 9 s 4 mm → 3 s	Ø10 → 4 s	70 x 60 x 120 / 132.5	80 x 60 x 120 / 144.5	22 kW

# SMALL Ø16 INDUCTORS

	S90 058927	S70 061569	S180 059269	S20/B1 (20°) 064874	S180/B1 064881	S180/B2 064928	S180/B3W 067899
37 LG	✓*			✓			✓
39 & 50 LG				✓ with adapter 28S			
110, 160 & 220 LG				✓ with adapter 32S			

Ø 20	S20/D20 078796	S90/D20 078871	S180/D20 069985	S20/D25 078802	S90/D25 078888	S180/D25 069992	S20/D30 078819
Ø 25	S20/D30 078819	S90/D30 078895	S180/D30 070592	S20/D35 078826	S90/D35 078901	S180/D35 070608	S20/D40 078833
Ø 30	S20/D40 078833	S90/D40 078918	S180/D40 070615	S20/D45 078840	S90/D45 078925	S180/D45 070622	S20/D50 078857
Ø 35	S20/D50 078857	S90/D50 078932	S180/D50 070639	S20/D55 078864	S90/D55 078949	S180/D55 070646	
37 LG	✓ S20/D20-D35, S90/D20-D35, S180/D20-D35						
39 & 50 LG	✓ with adapter 28S						
110, 160 & 220 LG	✓ with adapter 32S						
<b>Protection kit for L180/D inductors</b> - Kit de protection pour inducteurs boucle 077386							

S180 HEAT TUBE D37 078604	S180 HEAT TUBE D40 078611	S180 HEAT TUBE D50 078628
39 & 50 LG	✓ with adapter 28S	
110, 160 & 220 LG	✓ with adapter 32S	

<b>DIFFICULT ACCESS ADAPTERS</b>			
	90°-S 082663		✓ compatible with 180/B1
			✓ compatible with 180/B2
			✓ compatible with 180/B3W
<b>ADAPTERS</b>			
	28S M28 Ø16 064485		32S M32 Ø16 064508
39 & 50 LG	✓ 28S M28 Ø16		
110, 160 & 220 LG	✓ 32S M32 Ø16		

<b>Boxes - Boîtes</b>	 <b>28S/B type W</b> for 39LG & 50LG 072497 included: S20/B1 (x1) S180/B1 (x1) S180/B3 (x1) 28S (x1) B1 (x1) B3 (x1)	 <b>32S/B type W</b> for 110LG, 160LG & 220LG 072503 included: S20/B1 (x1) S180/B1 (x1) S180/B3 (x1) 32S (x1) B1 (x1) B3 (x1)	 <b>L box</b> 065796 included: L70 (x1) L180 (x1)
-----------------------	--	---	--

<b>Ferrites - Ferrites - Ferritaufsatz</b>						
	B1 053823	B2 053458	B3 067875	B4 053755	B5 079489	Spiral 069701
	B1 (x5) 079380	B2 (x5) 053458	B3 (x5) 067875	B4 (x5) 053755	B5 (x5) 079489	B1 (x5) 079397

**Glue kit for inductor**  
 Kit de colle pour inducteur  
 075948

EA 9487  
 Colle-Stick bi-composants  
 Power Epoxy 150°C  
 054851

**Trolley for inductor for adapter 32L**  
 Chariot pour inducteur pour adaptateur 32L  
 075955

4 to 8 wheels

# LARGE Ø32 INDUCTORS

	L90 (90°) 059788	L70 (70°) 059771	L180 059795	L180/Spiral 065000	L20/B4 067882	L180/B4 079786	L20 Alu Glove 069114
39 & 50 LG	✓ with adapter 28L						
110, 160 & 220 LG	✓ with adapter 32L*		✓ with adapter 32L		✓ with adapter 32L*	✓ with adapter 32L	✓ with adapter 32L

	Ø 60	Ø 70	Ø 80	Ø 90	Ø 100	Ø 110	Ø 120	Ø 130	Ø 140	Ø 150	Ø 160	Ø 170	Ø 180	Ø 190	Ø 200
	L20/D60 078956	L90/D60 079106	L180/D60 069923	L20/D70 078963	L90/D70 079113	L180/D70 069930	L20/D80 078970	L90/D80 079120	L180/D80 069121	L20/D90 078987	L90/D90 079137	L180/D90 069947	L20/D100 078994	L90/D100 079144	L180/D100 069954
	L20/D110 079007	L90/D110 079151	L180/D110 069961	L20/D120 079014	L90/D120 079168	L180/D120 069978	L20/D130 079021	L90/D130 079175	L180/D130 069981	L20/D140 079038	L90/D140 079182	L180/D140 069988	L20/D150 079045	L90/D150 079199	L180/D150 069995
	L20/D160 079052	L90/D160 079205	L180/D160 069998	L20/D170 079069	L90/D170 079212	L180/D170 069999	L20/D180 079076	L90/D180 079229	L180/D180 069999	L20/D190 079083	L90/D190 079236	L180/D190 069999	L20/D200 079090	L90/D200 079243	L180/D200 069999
39 & 50 LG	✓ with adapter 28L														
110, 160 & 220 LG	✓ with adapter 32L														

**Protection kit for L180/D inductors**  
 - Kit de protection pour inducteurs boucle  
 077386

<b>ADAPTERS</b>		
	28L M28 Ø32 064492	32L M32 Ø32 064515
39 & 50 LG	✓ 28L M28 Ø32	
110, 160 & 220 LG	✓ 32L M32 Ø32	

**Pre-heating & Fretting - Préchauffage et Frettage**

	Ø 20	Ø 25	Ø 30
> Ø 200 & < Ø 300	Production on request		
110, 160 & 220 LG	✓ with adapter 32L		

**Brasing - Brasage**

	L90 BRAZ 16 Ø 1/2" / 16 mm 076907	L90 BRAZ 28 Ø 1" / 28 mm 076921	L180 BRAZ 16 Ø 1/2" / 16 mm 076914	L180 BRAZ 28 Ø 1" / 28 mm 076938
110, 160 & 220 LG	✓ with adapter 32L*			

**Protection kit for BRAZ inductors**  
 - Kit de protection pour inducteurs brasage  
 077515

**Exchanger - Échangeur**

	L180R X Production on request
110, 160 & 220 LG	✓ with adapter 32L

# COMPLETE Ø28 INDUCTORS

C20/B1 056862	C180/B1 056879	C180/B2 056886
37 LG		
39 & 50 LG	✓*	
110, 160 & 220 LG		✓



# TRUCK TOOLS & MOBILE LIFTS

## TRUCK TOOLS

TROLLEY IW1	111
MULTITOOL TRUCK	111

## CAR LIFTS

SPOT LIFT	112
QUICK LIFT / AIR JACKS	114
MANUAL WHEEL LIFT	114
ERGO LIFT	115



TROLLEY IW1 / MULTITOOL TRUCK

# TRUCK TOOLS

**TROLLEY IW1**  
Impact wrench trolley -  
Support de clé à choc

max 6.5 bar

max 20 kg

063136



Youtube

### OPTIONS



Huile hydraulique  
- Hydraulic oil  
1l  
053397

Weight, vibrations  
& torque suppression -  
Suppression du poids,  
des vibrations et du couple



High dexterity -  
Liberté de  
mouvement

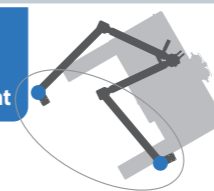

High maneuverability & stability -  
Grande maniabilité et stabilité

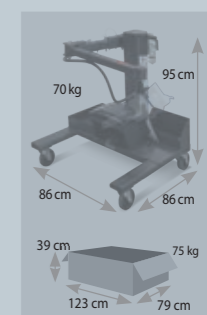
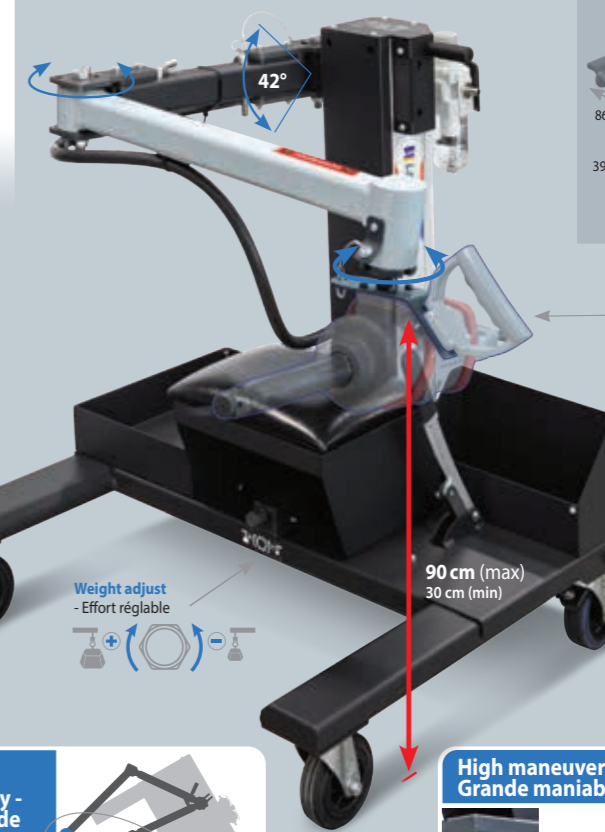

70 kg  
95 cm  
86 cm  
86 cm  
39 cm  
75 kg  
123 cm  
79 cm

Impact wrench -  
Clé à choc  
max 20 kg

Fixation  
36 x 36 mm  
→ 44 x 44 mm

Weight adjust  
- Effort réglable

90 cm (max)  
30 cm (min)



111

TRUCK TOOLS



INVEST IN THE FUTURE

## MULTITOOL TRUCK

SAFE EN 14238 + A1

max 200 kg

067158

### INCLUDED



Lifting tool for brake caliper  
- Outil de levage pour étrier  
de frein - Hebewerkzeug für  
Bremssattel



Brake caliper



Lifting tool for battery -  
Outil de levage pour batterie  
- Hebewerkzeug für Batterie

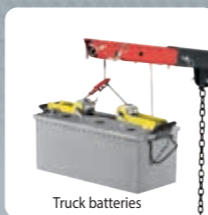

Truck batteries



Lifting tool for wheels -  
Outil de levage pour roues  
- Hebewerkzeug für Räder



SAFE  
EN 14238 + A1

ULTRA  
COMPACT  
103 cm

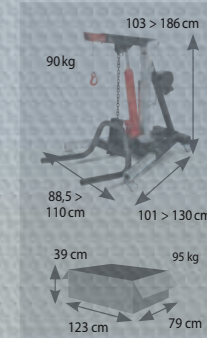

103 > 186 cm  
90 kg  
88.5 > 110 cm  
101 > 130 cm  
39 cm  
95 kg  
123 cm  
79 cm

### HEALTH CARE

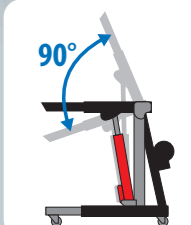

90°





# SPOT LIFT

## MOBILE LIFTS

### SPOT LIFT EASY

max Air 8 bar **SAFE EN 1494**  
**max 2.2 t**

#### HEALTH CARE



#### High stability - Haute stabilité



Included  
220 bar  
053588

**SAFE EN 1494**

#### SECURITY

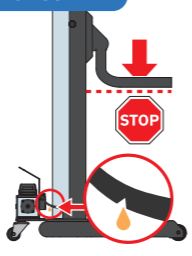

#### OPTIONS

Hydraulic oil 1L  
- Huile hydraulique  
1L  
053397

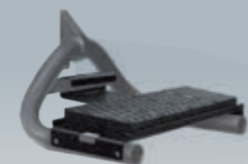

Rocker panel lifting tool  
- Outil de levage pour bas de caisse  
- Auflage für Seitenschweller  
053236



### SPOT LIFT PRO

max Air 8 bar **SAFE EN 1494**  
**max 2.2 t**

053557

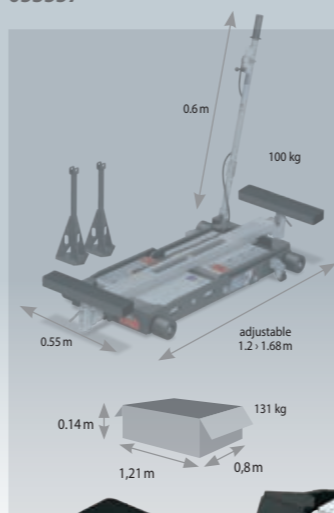

### SPOT LIFT PRO MOB

max Air 8 bar **SAFE EN 1494**  
**max 2.2 t**

055896



**60 cm (max)**  
**14 cm (min)**

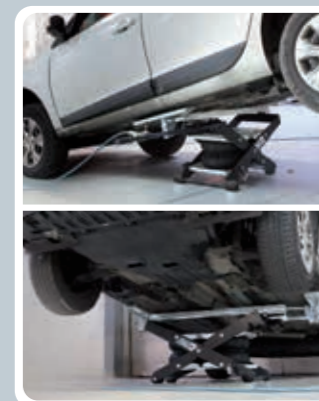
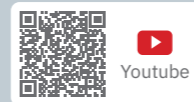

#### OPTIONS

Height adjuster for 4x4 & utility vehicles  
- Réhausseur pour 4x4 et utilitaires  
- Erhöhung f. 4x4 und Leicht-LKW



Pads - Patins for Audi & BMW (x 2)  
053717

Ramps - Ramps 700 x 200 x 80 mm (x 2)  
056787

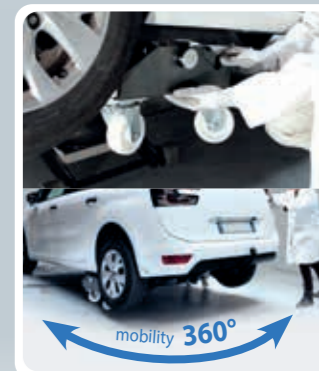

#### OPTIONS

SPOT LIFT PRO MOB  
Réhausseur pour 4x4 et utilitaires  
- Height adjuster for 4x4 & utility vehicles  
- Erhöhung f. 4x4 und Leicht-LKW



Patins - Pads for Audi & BMW (x 2)  
061606

Ramps - Ramps 700 x 200 x 80 mm (x 2)  
056787

#### AUTO ROLL

min 500 mm  
max 1700 mm (AUTOROLL 1.0m)  
max 2240 mm (AUTOROLL 1.55m)  
**2.5 t max**

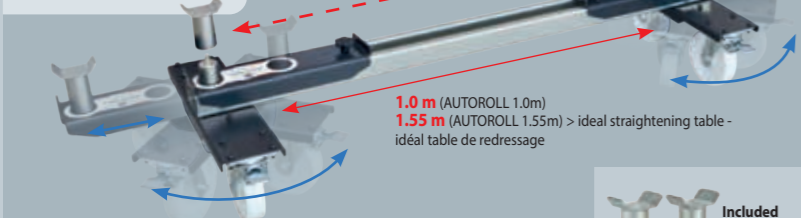

AUTO ROLL 1.0 m / 1.2 t  
059047



AUTO ROLL 1.55 m / 1.2 t  
063839



#### AFTER LIFT AUTO ROLL

1 2  
**2.5 t max**

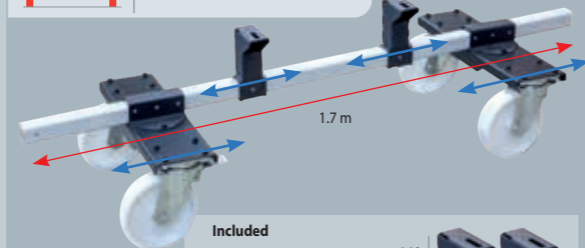

067967



#### WHEEL TROLLEYS - Tabourets de manutention - Radhocker

048768  
230 mm  
kg 650 kg max



#### MECHANICAL LIFTING JACKS - Chariots de manutention prise sous roue - Kfz-Montagelift, fahrbar

071995  
567 kg max (2x) 16 kg

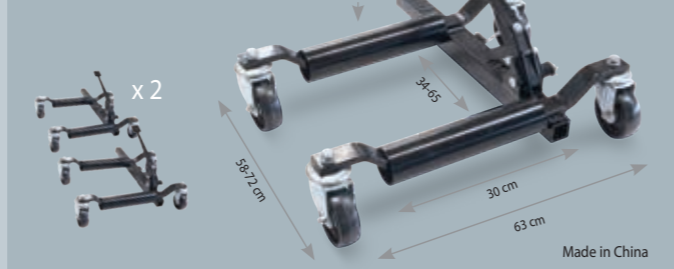

## QUICK LIFT L520E

062184

220 V, 1 ph  
0.75 kW

Included  
Hydraulic oil 5 L  
- Huile hydraulique  
5 L  
062160

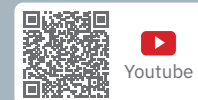

10 cm  
12 cm  
5 cm  
Pads - Patins  
Included (x 8)

SAFE  
EN 1493

2.5 t max

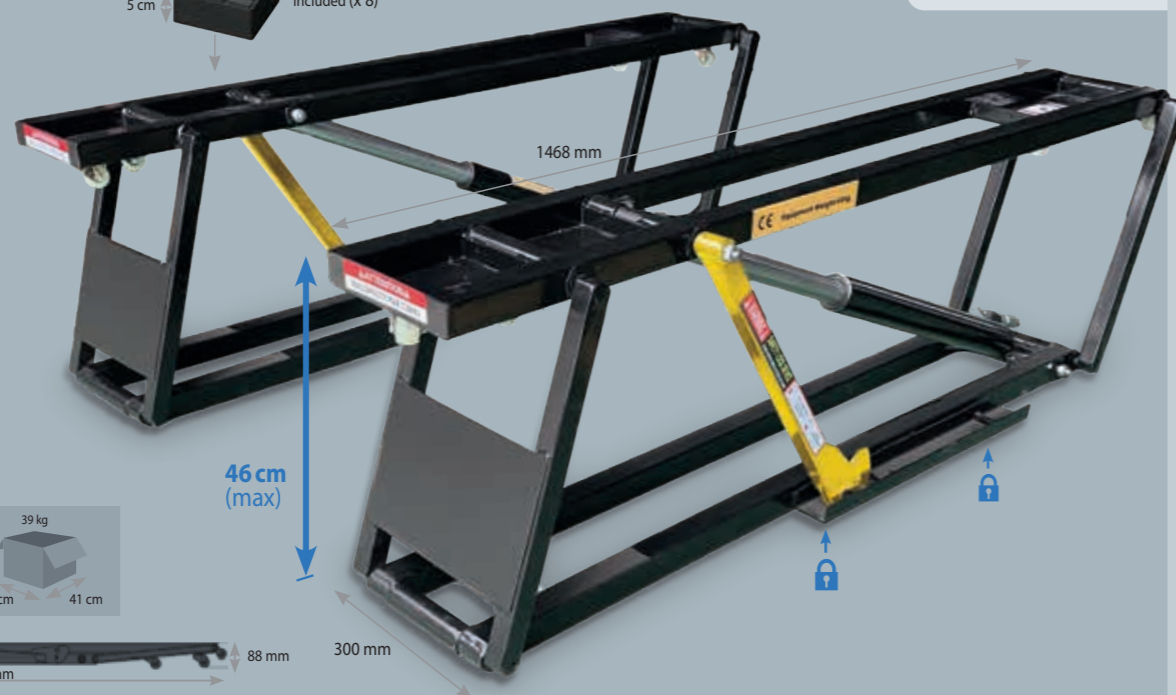

11 cm 43 kg  
181 cm 37 cm  
x 2 +  
43 kg 39 kg  
54 cm 41 cm

Made in China

### OPTIONS

Extensions 1680 mm x 2  
066328

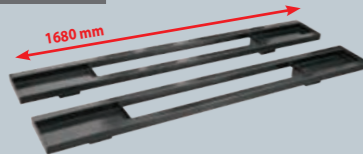

x4 Patins à rainures  
071933

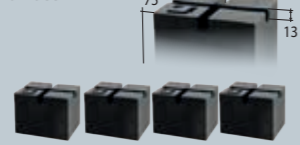

Pads for SUV x4 - Patins pour SUV x 4  
065017



Wall mount -  
Support mural  
071926



## AIR JACKS



AIR JACK VAN 2T  
058330

2T max

49 cm max  
20.5 cm min  
17 kg



AIR JACK CAR 2T  
058323

2T max

32.6 cm max  
13.2 cm min  
14 kg



## MANUAL WHEEL LIFT

Wheel lift trolley  
- Lève roue à treuil  
- Radmontage-Heber  
061385

min: R13 / 135 / 65  
max: R22 / 300 / 35  
40 kg max

27 cm 42 kg  
117 cm 28 cm

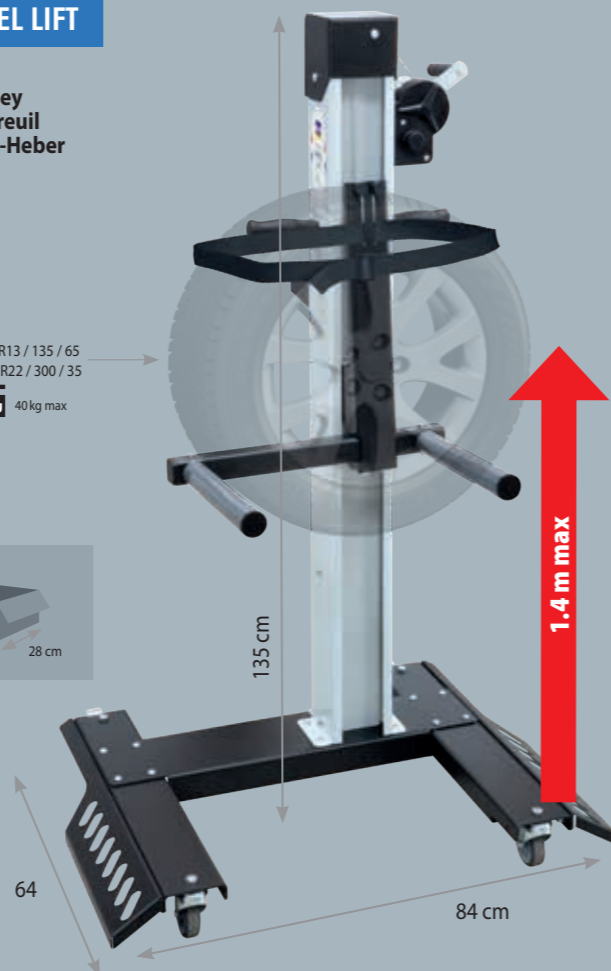

## ERGO LIFT 1000 ROLL

Air 7-8 bars

SAFE  
EN 1493

max 2.5 t

Without accessories:  
067950

24 cm 437 kg  
Ergo Lift  
226 cm 115 cm

High stability - Haute stabilité

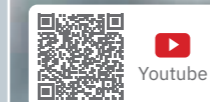

PATENT  
PENDING

Handle for adjusting the  
automatic locking support arms  
- Poignée de positionnement  
des bras porteurs avec  
verrouillage automatique

SAFE  
EN 1493

included:

(x4) 4 cm + (x4) 6 cm

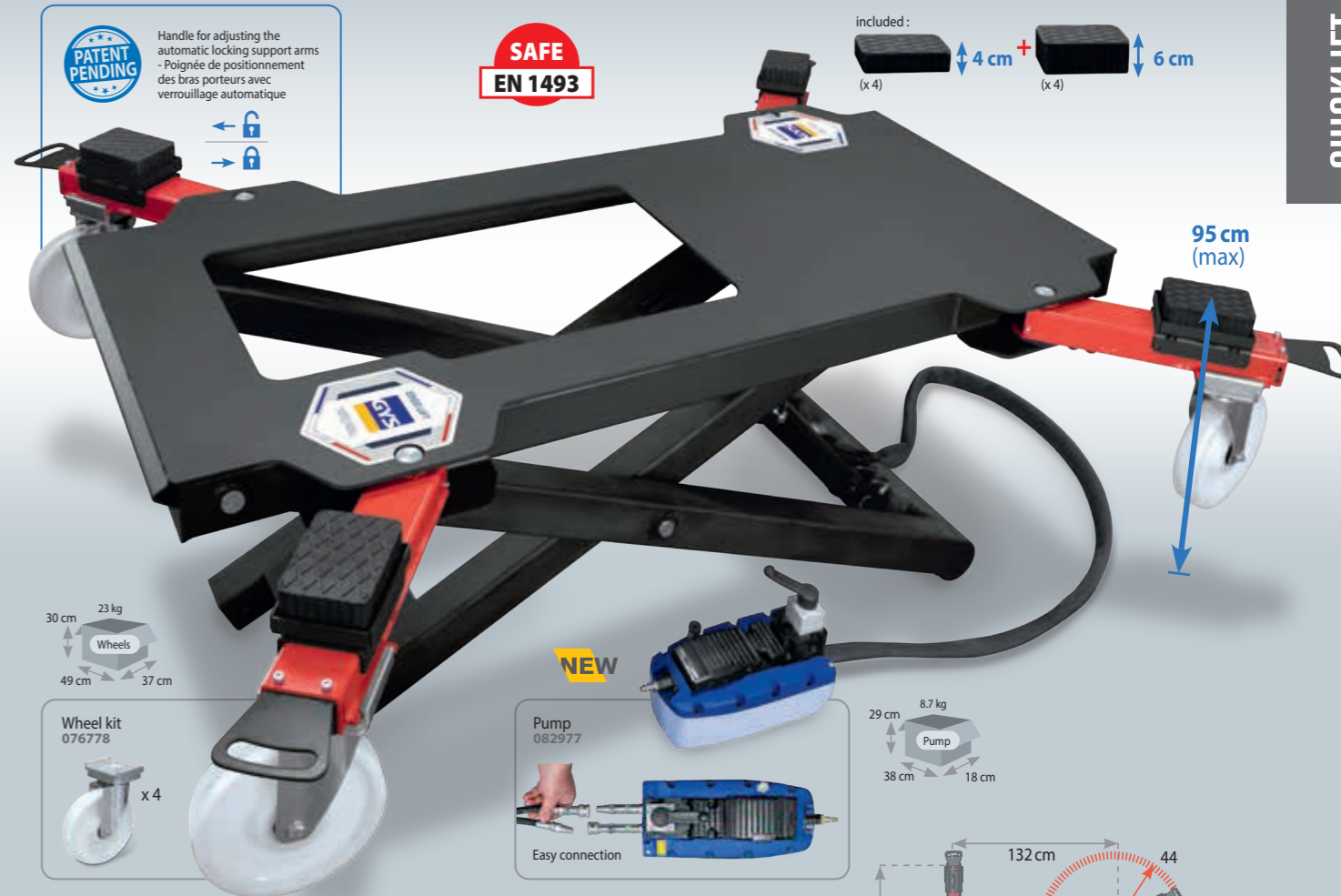

10 cm (min)

395 kg

196 cm 110 cm

132 cm 44  
180 cm 102 cm  
196 cm

### OPTIONS

Pads for SUV x4  
- Patins pour SUV x 4  
065017



32 cm 9 kg  
Ramps  
90 cm 35 cm

NEW  
Ergo Lift ramps x2  
- Rampes Ergo Lift x2  
082717

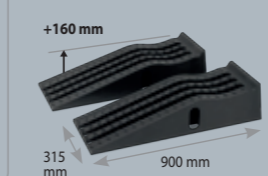

for Electric Vehicles  
> 2 tons

NEW

Capacity:  
max 3.5 t

Pack ERGO LIFT  
1000 ROLL  
+ wheels

076792



+ Wheel kit  
076778

NEW  
Pack ERGO LIFT  
1000 ROLL  
+ wheels + ramps

082984





## + ACCESSORIES

WELDING HELMETS	118
FUME EXTRACTION	121
WINDSCREEN REPAIR	122
BUMPER REPAIR	124
HAND TOOLS	126
PNEUMATIC TOOLS	128
SANDING & DUST EXTRACTION	130
WORKING LIGHTS	132
WORKING SUPPORTS	134
SAFETY PROTECTION	137



# HELMETS VENTILATED

IDEAL

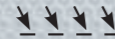

DIGITAL MEMORY & REGULATIONS ELECTRONIC



**GYSMATIC 3/9-13 G AIR**  
065727  
069602

100 x 60 mm

0.08 ms



**GYSMATIC 5-13 G AIR XXL**  
047846  
028852

100 x 83 mm

0.1 ms



included with GYSMATIC 5/13 G AIR XXL

**Filtration class EN 12941 : TH2 P R SL**  
Air 165 / 200  
220 L/min  
Battery included

**OPTION Filter TH3**  
065734



Battery charger  
037472  
028869



Battery included  
037465



038424 x1



038417 x5

LENSES - Verres - Schutzgläser

			TRUE COLOR	HF	DELAY								L x W x H cm / g	MASK BRAND
114 x 133 (x10)	043893	G: 106 x 66 (x10)	043886	GYSMATIC 3/9-13 G AIR	3-9>13	0.08 ms	✓	0.10>0.90 s	1/1/1/2	4 HIGH SENSITIVITY	XL: 100x60 mm	✓	28 x 25 x 28 / 1230	Gys
114 x 133 (x10)	043893	106 x 89,5 (x10)	046825	GYSMATIC 5-13 G AIR XXL	4-5>9 / 9>13	0.10 ms	✓	0.1 > 0.9 s	1/1/1/1	4 HIGH SENSITIVITY	XXL: 100x83 mm	✓	27 x 25 x 28 / 1000	Gys

## FUME EXTRACTION SYSTEMS - Aspirateurs de fumée - Rauchgasabsauggerät

**UNI 2.0 RE**

- 400V 3~
- 50 Hz
- 1100 W
- 1500 m<sup>3</sup>/h max
- arm 3 m
- no plug
- 100 kg
- extraction 0.5 m/s

122 x 67 x 145 cm / 111.5 kg

061545



Ø 150 mm

Included  
**Pré filtre, treillis Aluminium**  
Class of filtration G3 EN 779  
+ **Filtre - Coal Filter EPA E12**  
EN 779, Filtration >99.5 %  
046467

**Options**  
**Filtre à charbon actif - Coal filter**  
✓ UNI 2.0 RE  
064522

**EVO 2.1 RE**

- 230V 1~
- 50 Hz
- 1100 W
- 1200 m<sup>3</sup>/h max
- occasional
- arm 3 m
- included
- 85 kg

96 x 95 x 162 cm / 114 kg

061552



Ø 150 mm

Patented - Breveté

792 mm

347 mm

Included  
**Pré filtre, treillis Aluminium**  
Class of filtration F15 G2 EN 779  
+ **Filtre - Coal Filter HEPA H13**  
EN 779, Filtration >99.95%  
046498

## FUME EXTRACTION TORCHES - Torches aspirantes - Rauchgas-Absaugbrenner - Antorcha con aspiración de humos



BINZEL

	Steel/Stainless steel - Acier/Inox - Stahl/Edelstahl			
	AIR		LIQUID	
	150 A	250 A	350 A	500 A
original equipment	M6	M6	M8	M8
Ø	Ø 0.8	Ø 1.0	Ø 1.2	Ø 1.2
X % 40°C - ArCO <sub>2</sub>	150A - 60%	200A - 60%	290A - 60%	380A - 100%
GRIP	GRIP	GRIP	GRIP	GRIP
L	3 m	3 m	4 m	4 m
Ref.	043251	040540	040557	040564

For fume Extraction Torches - Pour torches aspirantes

BINZEL  
073715



- 230V / 1 ~, 1100 W
- 230 m<sup>3</sup>/h max
- 190 mbar max
- 25 kg, 590 x 425 x 825 mm
- 76 db
- Filter auto cleaning system - Système de nettoyage automatique du filtre - Automatische Filterabreinigung

Filtre Classe M, EN 60335-2-69

included: 5 m, Ø50

• External evacuation Ø50 (hose not included)  
• Évacuation extérieure Ø50 (tuyau non inclus)

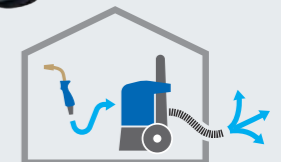

BINZEL

**PROFESSIONAL BOX SET FOR WINDSCREEN REMOVAL** - Coffret de découpe pare-brise  
- Frontscheiben-Trennsystem für Akkuschrauberbetrieb

MADE IN  
HIGH  
QUALITY  
GERMANY

057654

included  
Axe enrouleur  
068100

included  
65 m  
resistance 170 kg  
Ø 0.79 mm  
058125

optional  
65 m  
resistance 190 kg  
Ø 0.92 mm  
069275



**OSCILLATING PNEUMATIC SAW FOR WINDSCREEN REMOVAL** - Couteau pneumatique de découpe pare-brise  
- Druckluft-Trennmesser für Windschutzscheiben

057623



Included  
57 mm  
057845

90 mm  
057852

8 mm  
057876

35 mm  
057838

U  
36 mm  
057869



**REMOVAL TOOL FOR WINDSCREEN WIPER ARMS** - Extracteur d'essuie-glace - Wischerarm-Abzieher

UNIVERSEL  
057630



EXPERT

Accès difficile  
- Difficult access  
057647



**WINDSHIELD CUTTING KIT** - Système de découpe pare-brise à cliquet  
- Set zum Lösen von Windschutzscheiben

054738

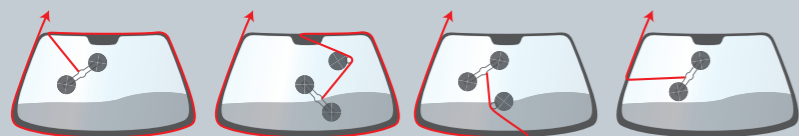

**DASHBOARD PROTECTOR** - Protections tableau de bord  
- Armaturenbrett Schutz

053120

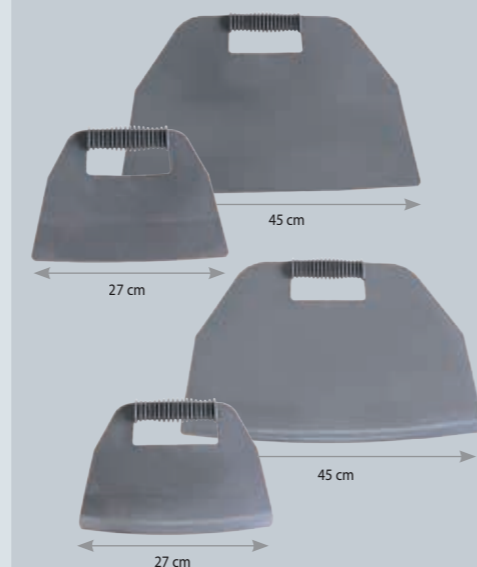

**WINDSHIELD CUTTING TOOL** - Outil découpe pare-brise  
- Windschutzscheiben Demontage-Set

051935



**WINDSCREEN JOINT-CUTTING KIT** - Kit découpe joint de pare-brise - Scheibentrenn-Werkzeug-Set

051898



Corde à piano torsadé (22 m)  
- Windscreen seal cutting wire  
(twisted)  
- Piano-Schneiddraht, gedreht,  
22 m Rolle

051911

Corde à piano carré (50m)  
- Windscreen seal cutting wire  
(square)  
- Vierkant-Draht,  
50 m Rolle

051881

**SUCTION LIFTING PADS** - Ventouses - Saugnapfwerkzeug für Spiegelgläser

056695



051966



x6  
057609

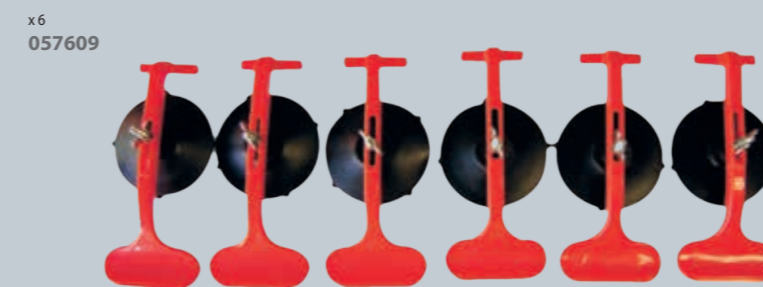

**COMPRESSED AIR POLISHER** - Renov'Polycarbonate - Druckluftpolierer

Complete pack

1 orbital sander  
+ 1 polisher  
- 1 ponceuse orbitale  
+ 1 lustreuse

052086



2 SPEED

+

+

+

+

+

+

+

+

+

+

+

+

+

+

+

+

+

+

+

+

+

+

+

+

+

+

+

+

+

+

Ø 76

P 500 (x 10)  
P 800 (x 10)  
P 1500 (x 10)  
P 3000 (x 10)

polisher Ø75  
058224



P 500 x 50 052017  
P 800 x 50 052024  
P 1500 x 50 052031  
P 3000 x 50 052048



**HOT STAPLER FOR BUMPER REPAIR** - Agrafeuse pour réparation pare-chocs - Stoßstangen Reparatur Kit

052925

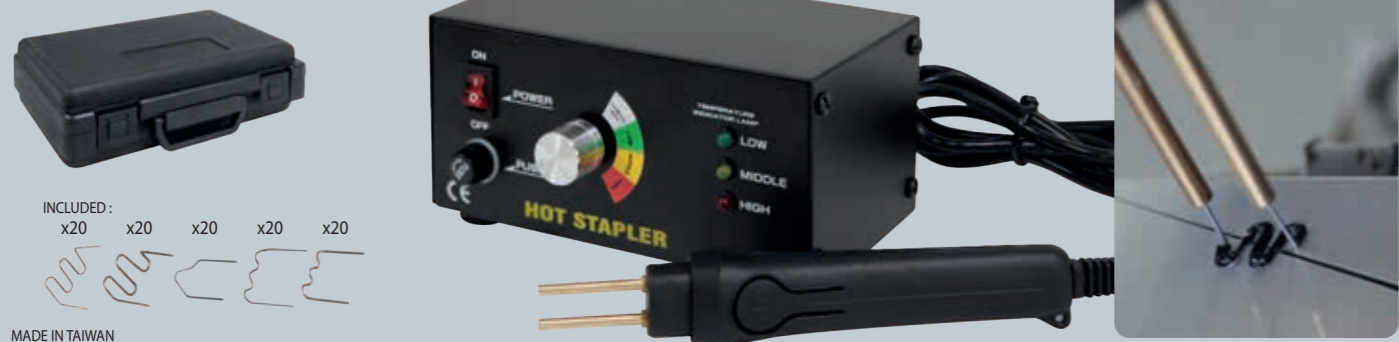

INCLUDED:  
x20 x20 x20 x20 x20

MADE IN TAIWAN

**PORTABLE**  
Battery operated - Sur batterie  
058118

included  
Li-ion battery 3.7 V  
048669  
included adapters:  
EUR, UK, USA & AUS

Charger included  
048652

MADE IN TAIWAN



INCLUDED:  
Ø 0.6, x100 Ø 0.8, x100  
Ø 0.6, x100

Staples - Agrafes	V	U	N	W	M
	Inside corner - Angle interne étroit Ø 0.7 mm	Crack alignment - Alignement de fissure Ø 0.7 mm	Large crack - Fissure importante Ø 0.7 mm	Internal angle - Angle interne Ø 0.7 mm	External angle - Angle externe Ø 0.7 mm
	x 100 047990	x 100 047983	x 100 047976	x 100 047969	x 100 047952
052413	= x 50	+ x 50	+ x 50	+ x 50	+ x 50

**PIERCING KIT FOR BUMPER SENSORS** - Coffret de perçage pare-chocs pour détecteurs - Lochwerkzeug für Stoßfänger



PRO +  
059139

Ø 17-18-18,2  
19-20-22,5-24  
26-26,7-32 mm



**FREEZER**

Freezer spray  
- Spray refroidisseur

-50 °C

400 ml

(x 12)  
048898



**TOOL FOR REMOVING BUMPER** - Outil de déclipsage pare-chocs



076518



x15  
076525

**HAND SEAMER FOR PLASTIC REPAIR** - Pince de serrage pour réparation des plastiques

082014



**PLASTIC WELDING STATION** - Station de soudage des plastiques - Kunststoff-Schweißset



320 W - 230 V, 1-50 Hz  
Temperature: 160 < 480°C  
▲ 3.4 kg  
Length of hose: 1 m  
Air flow: 24 l/min

Station seule  
- Station only  
064072



Ø 5 mm  
066694  
Ø 8 mm  
066700

plastic rods - baguettes plastique 440 mm	PP / EPDM	▲ 4 mm	x 10	066304
		■ 6 mm	x 10	067622
		■ 8 mm	x 10	066298
	ABS	▲ 4 mm	x 10	071322
		■ 8 mm	x 10	071339

Station	PP/EPDM			Pressure wheels	Mini milling machine	Scraper
	4mm (x10)	6mm (x10)	8mm (x10)			
064072	✓					
070974			✓			



Scraper - Grattoir  
068032

Pressure wheels  
- Roulette de  
compression  
058231

Mini milling machine  
- Mini fraiseuse  
063228

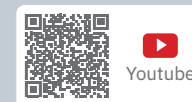

**WELDING KIT FOR PLASTICS** - Kit de soudage des plastiques - Kunststoff-Schweißset



1 600 W - 230V - 50/60 Hz  
max. 230 l/min  
▲ 1.3 kg / -L- Ø100 x 300mm,  
poignée Ø 56mm.

057678

3m



x10  
052956

x1  
25 x 12.5 cm  
052949



Options

TIP Ø5  
061262

TIP insert Ø5  
061279

**BRAZING AUTOMOTIVE PLASTICS REPAIR KIT** - Coffret de réparation des plastiques automobiles - Kunststoff Reparatur Set

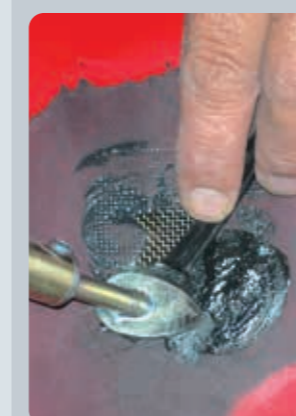

052932

MADE IN BELGIUM



x10  
052956

25 x 12.5 cm  
x2  
052949



057258

052963

**HAND TOOLS - Ausbeulwerkzeug**

**• FULL PACK = 061637**

MADE IN GERMANY

50 mm

15

290 mm

275 mm

390 mm

Ø 50 mm

053311 053298 061309 053335 053342 053328 053281

**MADE IN HIGH QUALITY GERMANY**

**+ • MEDIUM PACK 051133**

051430 051416 051454 051447 051409

051423

(9 dents/pouce - 9 teeth/inch) 062351

(15 dents/pouce - 15 teeth/inch) 062368

0.70 kg 051485

0.95 kg 051478

1.33 kg 051461

**PLANISHING HAMMER BLACKTEC®**

077270

Rubberised gripping - Manche en caoutchouc

MADE IN GERMANY

Corrosion resistant

**BURR REMOVER**

079854

x 10

**CONTOUR GAUGE - Jauges de profil - Konturenlehre**

052840 250 mm

057265 500 mm

**GAPPING GAUGES - Jauges de positionnement - Spaltmaßlehre**

x2 054752

**FENDER ROLLER TOOL SET - Outil de remise en forme passage de roue**

060791

**ALU HAMMERS - Marteaux alu**

020986

**FORMING TOOLS - Outils de forme - Formgebungswerkzeuge**

051195

180 x 70 x 65 mm

280 x 95 mm

280 x 95 mm

75 x 65 mm

**BODY LINE TOOL - Traceur de ligne carrosserie - Markierhilfe für Kanten**

078758

170 mm max

**FIXED HINGE BENDING TOOL - Redresseur de charnière de porte**

051102

Door hinge straightener - Redresseur de charnière de porte - Türgelenkausrichter

40 mm max

**LIP PLIER - Pince à lèvres - Falzzange gebogen**

079649

45 mm

**PLANISHING KIT FOR CAR BODY (SET OF 3 HAMMERS + 4 DOLLYS) - Kit marteaux et tas - Karosseriehammer & Handfaust Kit**

057579

40 x 40 mm 70 x 90 mm 1.4 kg 061408

117 x 57 mm 1.2 kg 061415

117 x 57 mm 1.2 kg 061422

**SET OF 30 TOOLS FOR SCRAPING/SANDING AND PAINT REMOVAL - Outils de dégarnissage et racle - Polster & Schaber Kit**

057616

**HAND CHISEL FOR CAR BODY - Burins - Meißel für Karosserie**

26 x 7 mm 26 mm 230 mm 057586

60 x 11 mm 60 mm 245 mm 057593

**SET OF 4 NYLON CHISELS - Jeu de 4 burins en nylon - 4 Kunststoffmeißel**

054745

273 mm

19 mm (x1) 25 mm (x1)

22 mm (x1) 38 mm (x1)

**SET OF PLIER + 10 STAPLES - Coffret pinces à agrafes**

082175

NEW

5x 5x

0 - 2.5 mm (x10) 082182

2.5 - 5 mm (x10) 082199

**SET OF 3 SCRAPING KNIFES - Couteaux racleurs**

061439

15 mm

20 mm

30 mm

**SET OF 3 CHISELS - Lot de 3 burins de séparation éléments collés - 3 Meißel**

076754

250 mm

300 mm

300 mm

**AXIAL-GRIP PLIERS - Pinces axiales**

050242

Type I Type J Type JJ Type W Type LL Type G

280 mm 061378 x6

610 mm 061354 x2

80 mm

410 mm

460 mm 061361 x4

Flat nose - 610 mm 061347 x2

240 mm

410 mm

**LOCK-GRIP PLIERS - Pinces étau mono serrage**

Flat nose - 460 mm 050112 x6

240 mm

KIT: 050266 x3 x3 x5 x5 = 16

Flat nose 280 mm



### MINI DISC SANDER - Mini-meuleuse - Druckluftschleifer

051829

Speed adjustment

Ø 75 mm

Speed rpm	Power W	dB	Air consumption l/min	Air pressure bar	cm	kg
18000	200	83	171	6.2	12	0.7

Included (x1) 052468

058248

MINI-FLEXIDISC LAMELLES ZIRCON Ø 50 mm

K 40 (x10) 058255  
K 60 (x10) 058262  
K 80 (x10) 058279

x2 Ø  
Ø 50 & 75 mm

Speed rpm	Power W	dB	Air consumption l/min	Air pressure bar	cm	kg
15000	84	91	6.2	10	0.6	

### AIR BELT SANDER - Ponceuse à bande à tête orientable - Druckluft Bandschleifer

060906

360°

520 mm

20 mm

Grain 60 (x 5) 060913  
Grain 80 (x 5) 060920  
Grain 100 (x 5) 060937  
Grain 36 céramique (x 5) 062535

Speed rpm	Air consumption l/min	Air pressure bar	cm	kg
16 000	171	6.3	34	1.2

### AIR BELT SANDER - Ponceuse à bande à tête orientable - Druckluft Bandschleifer

052819

360°

330 mm

10 mm

Grain 80 (x 10) 052833  
Grain 36 céramique (x 20) 062528

Speed rpm	Air consumption l/min	Air pressure bar	cm	kg
16000	171	6.3	26	0.9

### MINI ANGLE MILLING MACHINE - Mini-fraiseuse à renvoi d'angle - Mini-Winkelschleifer

051836

90°

Speed rpm	Power W	dB	Air consumption l/min	Air pressure bar	cm	kg
18000	500	81	85	6.2	18	0.7

### AUTOMATIC MANDREL DRILL - Perceuse mandrin automatique - Druckluftbohrmaschine m. Schnellspannfutter

051799

Ø 13

Speed rpm	Power W	dB	Air consumption l/min	Air pressure bar	cm	kg
800	300	92	170	6.2	18	0.9

### LONG HANDLED ANGLE GRINDER - Meuleuse d'angle - Druckluft-Winkelschleifer

057753

Ø 100 mm

± 1.6 mm, x5 057883  
± 0.8 mm, x5 058217

Speed rpm	Power W	dB	Air consumption l/min	Air pressure bar	cm	kg
14000	84	113	6.2	37	1.7	

### MINI ANGLE GRINDER - Mini-meuleuse à renvoi d'angle - Mini-Druckluftwinkelschleifer geräuschgedämpft

051867

90°

Ø 50 mm

Speed rpm	Power W	dB	Air consumption l/min	Air pressure bar	cm	kg
15000	200	86	85	6.2	18	0.75

(x1) 052772

### SAW FOR STRAIGHT CUT AND FILE - Scie coupe tôle droite et lime - Druckluftsäge und Feile

051805

(x5) 052789

included 058750

Speed rpm	Power W	dB	Air consumption l/min	Air pressure bar	cm	kg
5000	—	85	255	6.2	10	0.8

### PNEUMATIC SURFACE REMOVER KIT - Coffret décapeuse pneumatique - Druckluftentroster-Box inkl. Zubehör

051775

Roue gomme 115 x 14 mm 051874  
Roue à découper 115 x 14 mm 051843  
Adaptateur pour brosse 051768

Brosse souple Brins droits 0.5 mm 103 x 23 mm 052598  
Brosse dure Brins incurvés 0.7 mm 103 x 23 mm 051812  
Brosse souple Brins incurvés 0.5 mm 103 x 23 mm 051850

Speed rpm	Power W	dB	Air consumption l/min	Air pressure bar	cm	kg
4000	500	86	102	6.2	280	1.2

### PNEUMATIC FLANGE / PUNCHING TOOL - Pince à soyer et à trouser, pneumatique - Pneumatische Loch- und Absattzange

079892 Ø 8 mm  
052543 Ø 5 mm

0.8 > 1.2 mm

2 in 1

0.8 > 1.2 mm

### MINI MILLING MACHINE - Mini Fraiseuse - Mini-Schleifer

063228

Option Tungsten drill Ø 6 mm 054172

### PUNCHING TOOL FOR OVAL HOLES - Outil de poinçonnage oblongs - Langlochkarosserieblechzange

2.2 kg

6 mm 20 mm 052437  
8 mm 20 mm 067264

### BODY ZIPPER - Sertisseuse pneumatique - Pneumatic Crimper - Druckluftkantenformer

056930

MADE IN HIGH QUALITY POLAND

1) MINI  
2) initial W  
3) final M x < 2.4mm  
4) final D x > 2.4mm

Air pressure bar	cm	kg
5	28	2.1

### LASER CORD METAL SHEET CUTTER (NIBBLER) - Dépointeuse pour cordon laser ACIER - Trennwerkzeug für Lasernähte

054165

Ø 6 mm

STEEL Included 054172

### SPOT REMOVER - Dépointeuse - Druckluft-Schweißpunktbohrer

SPOT DRILL 050464

360°

Ø 8

Included: Tungsten Carbide Ø 8 for BORON/UHSS (x1)

HIGH QUALITY

Spot remover drill - Forets de dépointage - Schweißpunktfräse Tungsten Carbide for BORON/UHSS

Speed rpm	Power W	dB	Air consumption l/min	Air pressure bar	cm	kg
800	400	85	140	6.5	35	2.3

### PACK SPOT DRILL + 140 mm 061460

140 mm 061453

3-edge Ø 8 mm 053069

4-edge Efficiency ++ Durability ++

3-edge Ø 8 mm 053069  
Ø 9 mm 069763  
Ø 10 mm 053076  
Ø 8 mm 059849  
Ø 9 mm 069770



**FILM COATING THICKNESS GAUGE**  
- Détecteur épaisseur de peinture

059856

Measurement range : 0 - 1.80mm  
Resolution : 0.01mm / 1mm  
Measurement error : +/- 0.03 mm  
Power Supply : 2x 1.5V AAA batteries (included)  
Overall dimensions : 62 x 30.5 x 105 mm



**4 MAGNETIC PANEL EDGE PROTECTIONS**

- 4 protections magnétiques de ponçage pour bord de panneau

082793



**ELECTRIC SANDER & POLISHER**

- Ponçeuse /polisseuse électrique - Elektro-Polier-Schleifer

057999

Orbital 5.0 mm  
↓ 27 x 15 x 10 cm / 1.5 kg  
⊗ 37 x 18 x 12 cm / 1.9 kg

Speed : 4000, 7000, 9000 10000 rpm  
AC-in 220V - 230V / 50 - 60Hz

Light weight  
& Compact

Speed control

(( No vibration ))



**PNEUMATIC ALUMINIUM DUST ATEX VACUUM CLEANER**

- Aspirateur pneumatique pour poussières alu (atex)

058866

Dust container capacity : 25 l  
Working compressed air pressure : 7 bar  
Compressed air consumption at 6 bar : 800 l/min  
Suction connection diameter size : 50 mm  
Max suction capacity : 150 m³/h  
Max vacuum level : 2000 mm H₂O  
Recommended compressor power : 7.5 HP

↓ 74 x 45 x 45 cm / 22.5  
⊗ 78 x 58 x 97 cm / 25 kg



058293

Power supply : 230V / 50Hz  
Power : 1400W (max 2000W)  
Max. vacuum : 170 mbar  
Air flow : 2700 l/mn  
Drum capacity : 30 L  
Drum material : stainless steel

↓ 33 x 33 x 63 cm / 4.9 kg  
⊗ 38 x 38 x 67 cm / 7.8 kg

Manual or automatic



4m  
Input Ø 32 mm  
Mains cable length 4.5m

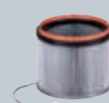

included  
Filtre - Filter  
075405



included  
Sac à poussières - Filter bag  
Capacity 5 kg  
x5  
058880



5 m  
Output Ø 29 mm  
Input Ø 35 mm

**GYS DUST EXTRACTOR** - Pneumatic dust vacuum cleaner for sander

**INNOVATIVE SUCTION SYSTEM**

Depression 1150 mm H₂O  
Air flow 600 l/min  
Air consumption 340 l/min

Adjustable sander pressure - Pression ponçeuse ajustable  
**5 bar max**

↓ 49 x 48 x 88 cm / 21.5 kg  
⊗ 81 x 40 x 49 cm / 24.1 kg



ATEX norm  
Group II - Category 3

EN 60335-2-69 : 2012

- ✓ **ROBUST**
- ✓ **QUICK & SAFE**
- ✓ **LOW AIR CONSUMPTION**  
(5 bar)
- ✓ **NO ELECTRIC MOTOR**
- ✓ **ENERGY SAVING**

Sanding discs box\*  
- Rangement pour disques de ponçage\*  
\* discs box not included - disques de ponçage non inclus

Grande maniabilité et stabilité  
- High maneuverability and stability

**EASY ACCESS**

Maintenance free  
- Aucune maintenance



**Consumables**



Sac à poussières - Filter bag  
Capacity 5 kg  
**Included x1**  
x5  
058880



5 m  
Ø 29 mm

Option :  
10m  
Ø 29 mm  
076013



Included  
Earth clamp  
safety



Grande maniabilité et stabilité  
- High maneuverability and stability



Pneumatic Sander  
- Ponçeuse pneumatique  
**MIRKA PROS 650CV**  
Ø 150 mm  
**071346**

**2 MODELS**

**GYS DUST EXTRACTOR**

**MANUAL**

Manual start  
- Démarrage manuel

071353



**GYS DUST SELF EXTRACTOR**

**AUTOMATIC**

Automatic start  
- Démarrage automatique

077058

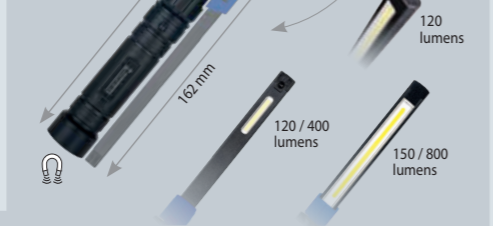
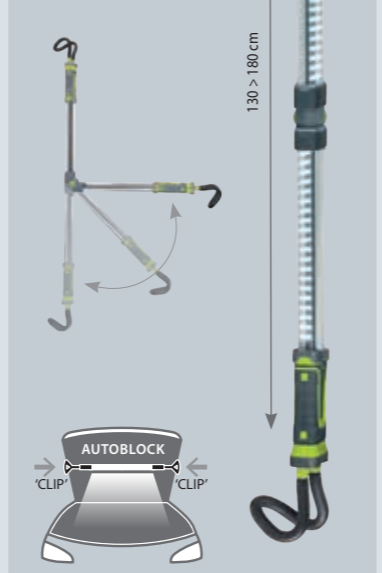
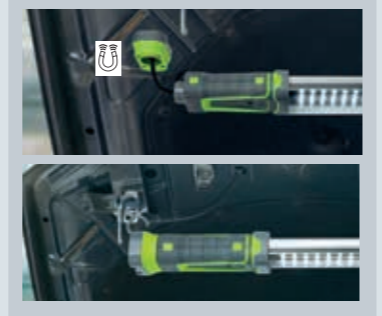

**HAND LAMPS - Lampes baladeuses - Handleuchte****PORTABLE TRIPOD HAND LAMP 250 L**  
**100-250 lumens (x3)**3 x 1 W COB LED  
3 x 3.6 V - 300 mAh  
AAA rechargeable, Ni-MH  
USB charging (6h)  
**operating time**  
High position: 1 h  
Low position: 3 h  
Flashing: 5 h↓ 10 x 10 x 26 cm / 0.6 kg  
⊗ 21 x 11 x 27 cm / 1 kg**PORTABLE HAND LAMP 400 L**  
**400 lumens**COB LED  
Li-ion  
Charging time: 8h  
**operating time**  
High position: 2.5 h  
Low position: 5 h  
Top light (1 W): 6 h↓ 7 x 4 x 23 cm / 0.3 kg  
⊗ 14 x 7 x 24 cm / 0.5 kg**PRO PORTABLE LAMP 600 L**  
**250-600 lumens**COB LED, 80 CRI  
3.7 V - 2200 mAh Li-ion  
micro USB charging (3.5 h)  
**operating time:**  
High position: 1.5 h,  
Mid position: 4.5 h,  
Top light (100 lumens): 10 hIP 54  
↓ 3 x 6 x 19 cm / 0.3 kg  
⊗ 9 x 13 x 24 cm / 0.6 kg**INSPECTION LAMPS - Lampes d'inspection - Inspektionslampen****INSPECTION HEADTORCH 280 L**  
**100-280 lumens**3 W COB LED, 80 CRI+, 6500 K  
3.7 V - 1500 mAh Li-po  
micro USB charging  
mains charger not incl.  
**operating time**  
High position: 2 h  
Low position: 6 h  
IP 65  
↓ 8 x 5 x 4 cm / 0.1 kg  
⊗ 5 x 11 x 18 cm / 0.2 kg**360° PORTABLE WORKSPACE LAMP 1000 L**  
**60-1000 lumens**>80 CRI SMD LED  
6500 K  
3.7 V - 5200 mAh Li-ion  
USB charging (4.5h)  
USB power supply  
**operating time** 2 > 27 hIP 54  
↓ 26 x 7 x 7 cm / 0.5 kg  
⊗ 8 x 8 x 35 cm / 0.7 kg**MINI INSPECTION LAMP 200 L**  
**120-200 lumens**COB LED, 80 CRI, 6500 K  
3.7 V - 700 mAh Li-ion  
micro USB charging (2.5 h)  
mains charger not included  
**operating time**  
High position: 1.5 h  
Low position: 4 h  
Top light: 3.5 h  
IP 20  
↓ 18 x 3 x 3 cm / 0.1 kg  
⊗ 18 x 5 x 3 cm / 0.2 kg**MINI INSPECTION LAMP 350 L**  
**0-350 lumens**COB LED  
3.7 V - 1100 mAh Li-ion  
USB charging (3 h)  
**operating time**  
3 > 6.5 hIP 20  
075894**PRO INSPECTION LAMP 600 L**  
**0-600 lumens**COB LED  
6500 K  
3.7 V - 2600 mAh Li-ion  
USB charging (4 h)  
**operating time**  
1.5 > 15 h↓ 38 x 4 x 5 cm / 0.3 kg  
⊗ 40 x 9 x 6 cm / 0.4 kg**PRO INSPECTION LAMP 800 L**  
**120-800 lumens**COB LED  
3.7 V - 2600 mAh Li-ion  
USB charging (4 h)  
**operating time**  
2.5 > 9 hIP 54  
075900**UNDER BONNET LAMPS - Lampes sous capot - Leuchte für Motorhaube****UNDER BONNET HAND LAMP 600 L**  
**500-1000 lumens**120 COB LED  
3.7 V - 4000 mAh Li-ion  
charging time: 10/12 h**operating time**  
High position: 4 h  
Low position: 8 h↓ 22 x 11 x 68 cm / 1.8 kg  
⊗ 24 x 12 x 70 cm / 2.3 kg**UNDER BONNET LAMP AND TRIPOD 800 L**  
**250-800 lumens**120 COB LED  
3.7 V - 4000 mAh Li-ion  
charging time: 10/12 h**operating time**  
High position: 3 h  
Low position: 6 h↓ 60 x 10 x 7 cm / 1.2 kg  
⊗ 61 x 15 x 12 cm / 2 kg**LED WORKLIGHTS WITH TRIPOD - Projecteurs led sur trépied - LED-Arbeitsleuchte mit Standfuß****TRIPOD LAMP 1800 L**  
**1800 lumens**3 x 55 COB LED  
total 165 LED1.8 m power cord  
059146

⊗ 95 x 15 x 14 cm / 3.2 kg

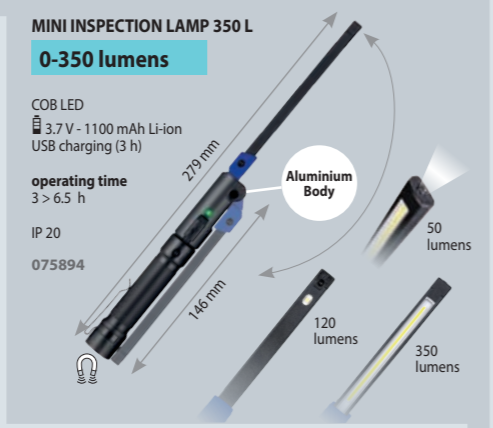
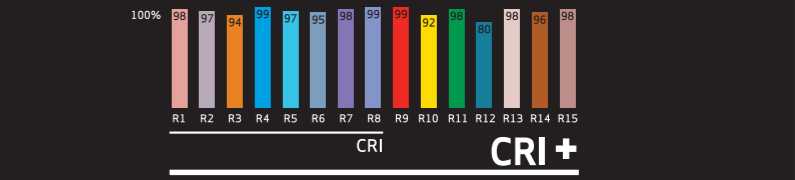
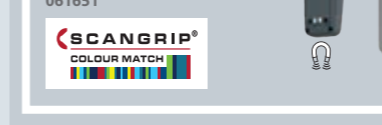
**TRIPOD LAMP 3000 L**  
**3000 lumens**35 W COB LED  
2 m power cordIP 44  
059979↓ 100 x 20 x 9 cm / 3.6 kg  
⊗ 103 x 22 x 10 cm / 4.1 kg**TRIPOD LAMP 4000 L**  
**4000 lumens**3 x 20 COB LED,  
total 60 LED3 m power cord  
059986↓ 21 x 15 x 114 cm / 5.7 kg  
⊗ 22 x 116 x 117 cm / 6.4 kg**DETAILING & COLOUR MATCH - Contrôle des couleurs - Fabnpassung & Aufbereitung****4500 K**  
**400 lumens****SUNCOLOR 1**  
COB LED, CRI > 95, 1100 lux3.7 V - 2600 mAh Li-ion  
USB charging  
**operating time:** 3 h  
↓ 6 x 3 x 19 cm / 0.6 kg  
⊗ 22 x 14 x 10 cm / 0.7 kg  
IP 65**3 COLORS**  
**2700 - 4500 - 6500 K****350-420-450 lumens****SUNCOLOR 3**  
COB LED, 96 CRI+  
3.7 V - 2600 mAh Li-ion  
micro USB charging (4 h)  
**operating time:** 2.5/4 h  
IP 65  
↓ 4 x 6 x 9 cm / 0.3 kg  
⊗ 9 x 13 x 24 cm / 0.6 kg**5 COLORS**  
**2700 - 3500 - 4500 - 5500 - 6500 K****500-1000-2000 lumens****SUNCOLOR 5**  
COB LED, 96 CRI+  
11.1 V - 4400 mAh Li-ion  
charger 110/240 V, 5 m cable, 15 V, 1.5 A  
charging time: 3.5 h  
**operating time**  
High position: 2 h, Mid: 4 h, Low: 8 h  
IP 65  
↓ 7 x 23 x 20 cm / 1.2 kg  
⊗ 9 x 25 x 24 cm / 1.9 kg**5 COLORS**  
**2500-3500-4500-5500-6500 K****50-200-500 lumens****SUNMATCH 4**  
COB LED, 96 CRI+, 700-1400 lux  
3.7 V - 2600 mAh Li-ion, USB charging  
**operating time:**  
High position: 2 h, Low position: 4 h  
IP 65  
↓ 4 x 6 x 19 cm / 0.3 kg  
⊗ 8 x 9 x 21 cm / 0.5 kg**UV CURING - SÉCHAGE UV**  
**UV LED λ 395-400 nm****Irradiance 6-15 mW/cm²****NOVA-UV S**  
3.7 V - 5400 mAh Li-ion  
COB LED, 1 m cable, 5 V, 2 A  
charging time: 3.5 h  
curing area: Ø 20 cm  
**operating time 1.5 h**  
IP 67  
↓ 7 x 17 x 16 cm / 0.9 kg  
⊗ 7 x 17 x 18 cm / 1 kg

**FRAMES SUPPORT - Tréteaux - Klappböcke**



**PREMIUM MASKING MACHINE - Chariot de luxe marouflage - Abdeckpapier-Ständer**

057333  
150 x 133 x 62 cm  
31 kg  
152 x 30 x 18 cm / 31.5 kg

**MASKING MACHINE - Chariot de marouflage - Abdeckpapier-Ständer**

056954  
150 x 62 x 110 cm / 11 kg  
154 x 30 x 19 cm / 12 kg

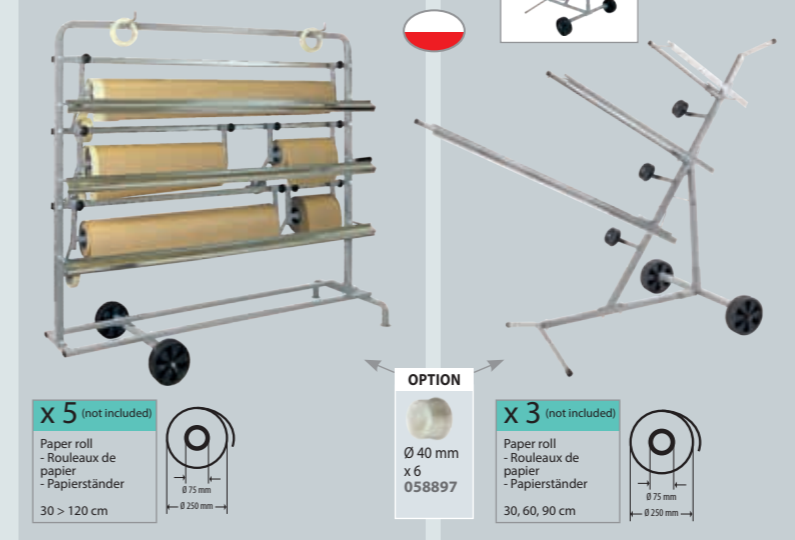

**STORAGE TROLLEY - Chariot de stockage - Lagerrollwagen**

040243  
71 x 90 x 197 cm / 41 kg  
x2: 90 x 6 x 147 cm + 97 x 74 x 24 cm



**FLAP LOCK - Tiges de blocage**

056732  
30 > 115 cm

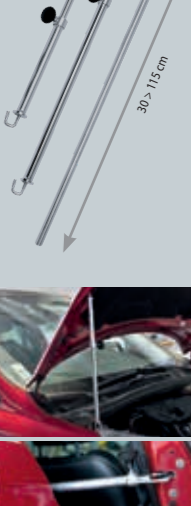

**ROTARY ELEMENT SUPPORT - Support pare-chocs - Lackierständer für Stoßstange, einstellbar**

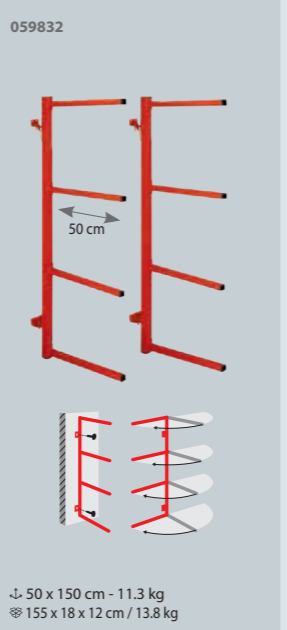

**WHEELS PAINTING SUPPORT - Support de peinture pour 2 jantes**

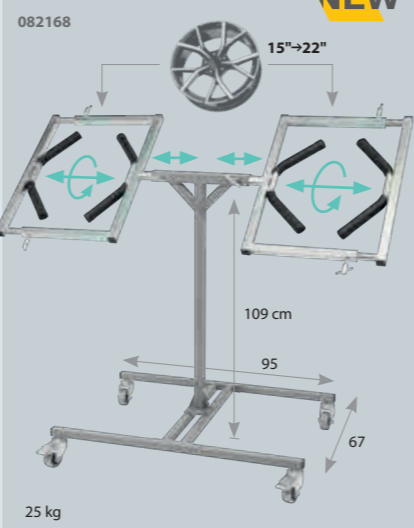

**ROUND STOOL WITH TOOL STORAGE - Tabouret - Werkstatt-Rollhocker**



**MECHANICS CREEPER WITH TILTING HEADREST - Chariot de visite - Werkstatt-Rollliege**



**ROUND STOOL WITH STORAGE - Tabouret d'atelier 3 tiroirs**



**ROTARY ELEMENT SUPPORT - Support élément rotatif - Lackierständer für Stoßstange, einstellbar**

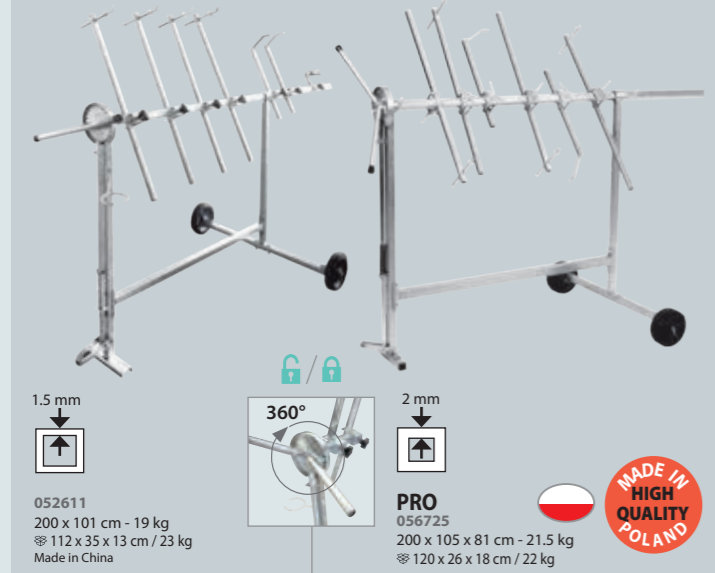

**UNIVERSAL SUPPORT - Chariot pour éléments de carrosserie - Universelle Ständer**

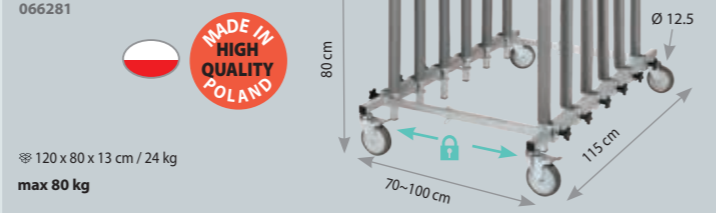

**EXTENDABLE SUPPORT - Chariot extensible pour éléments de carrosserie - Ausziehbarer Wagen**



**2 IN 1 MECHANICS CREEPER - Chariot de visite 3 en 1 - Werkstatt-Rollliege**

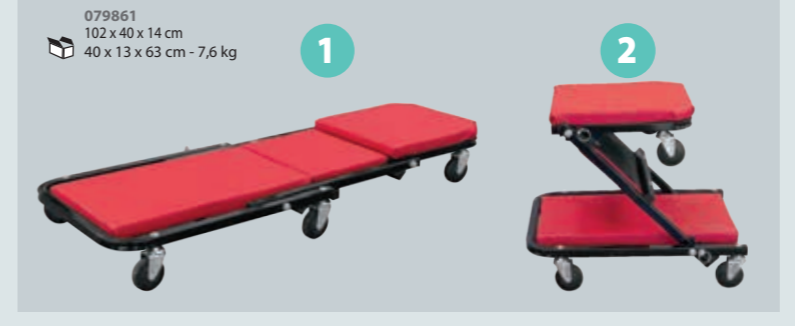

**150 kg ALU**

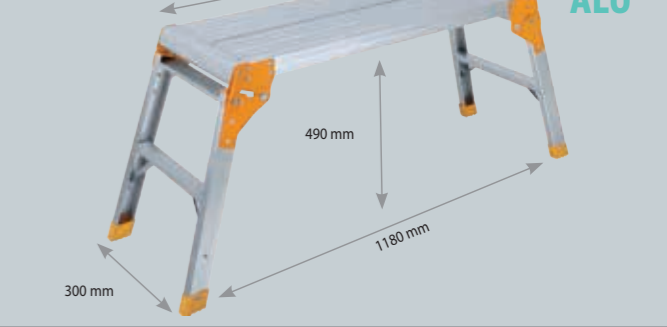

**FOLDING STEP STOOL - Marche pied (Aluminium) - Arbeitspodest klappbar**



**150 kg ALU**

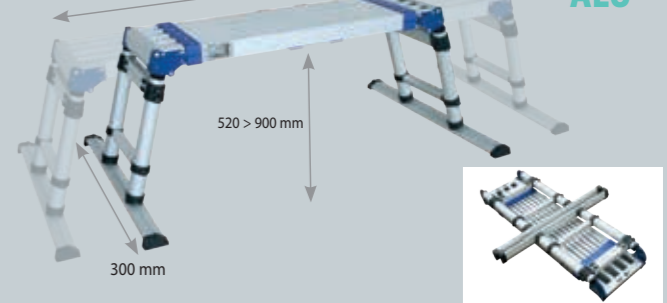

## WORKSTATION PREMIUM 5 DRAWERS - Servante premium 5 tiroirs

Ø 64 kg  
Capacity 320 kg



**NEW**

4 Keys - 4 Clés

### Complete carbody workstation 080119

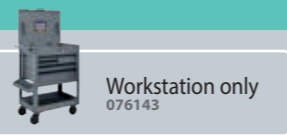

included



## MOBILE WORKSTATION - Table de travail mobile

079465  
Ø 120 x 82 x 18 cm / 40.3 kg



## WORKSTATION 3 SHELVES - Servante 3 plateaux

068056  
Ø 77 x 53 x 21 cm / 18.2 kg



## HEAT COVER - Couverture anti-chaueur - Hitzschutzdecke - Manta anti-calor - Protecção anti-aquecimento



PROTEC 550 550°C/1000°F - Class M0 2 m x 2 m - 580 g/m² 050495  
PROTEC 1200 1200°C/2200°F - Class M0 1.75 m x 1.5 m - 1200 g/m² 050204  
PROTEC 1300 1300°C/2400°F - Class M0 XL: 2 m x 1.8 m 620 g/m² 053595  
PROTEC 1300L 1300°C/2400°F XL: 2 m x 1.8 m 427 g/m² 060500

## SET OF 2 MAGNETS - Jeu de 2 aimants - Schweißmagnet



(x2) 052291

## MAGNETIC COVER - Couverture magnétique - Magnetschutzdecke



1.06 m x 0.6 m 061446

## RIDEAU DE SOUDAGE - Welding curtain and frame - Schweißerschutzwand



OPTI 215.0 Orange CE - 2 x 2.15 m EN 25980 - 2015/01 060470  
OPTI 200G Green T9 - 2 x 2 m EN 25980 - 2015/01 060463

## RESPIRATORY MASKS - Masques respiratoires - Atemschutzmaske - Máscaras respiratorias



FFP3 - EN 140 / EN 143 / EN 166 (x1) Size M/L 037021  
FFP3 - EN 140 / EN 143 (x1) Size M/L 037014  
Étui / Case 037045  
FFP3 - EN 143 : 2000 P3 Anti poussières / Anti odeurs 037038

## PROTECTION GOGGLES - Lunettes de protection - Schutzbrillen



EN 166  
Shade/IR0 042810  
Shade/IR0 042827  
Shade/IR5 042841  
Shade/IR0 047778  
Shade/IR0 047792  
Shade/IR0 042865  
Shade/IR0 047839

## GLOVES - Gants - Handschuhe - Guantes



Anti-cut - Anti coupure T9 045897  
EN388 4342  
✓ touch screen friendly - écran tactile High resistance anti-cut Anti coupure haute résistance EN 420 EN 388:4121 T9: 045910 T10: 045927  
High dexterity anti-cut - Anti coupure haute dextérité EN 420 EN 388:1121 T9: 045903 T10: 045934  
T10 064188 Cuir Leather Leder EN420 2003 Ultra Flexible EN388 2003  
EN388 4244 EN 407 424X4X EN12477 Class : A1 Heavy Duty T10 (MMA - MIG - Plasma) 045101  
Cuir Leather Leder EN388 2122 EN 407 322X2X EN12477 Class : A1 Gants PRO TIG T10 045194  
EN388 4244 EN 407 424X4X EN12477 Class : A1 Reinforced welding gloves - Gants de soudage renforcés T10 045873  
Cuir Leather Leder EN388 2011XX EN 407 41313X EN12477-B EN 420 Gants PRO TIG EXTRA T10 045323  
Cuir Leather Leder PRO 045217

## MULTI-USE LEATHER APRON - Tablier cuir multi-usage - Delantal de cuero multi-uso - Mehrzweck-Lederschürze



PRO 045217

**EQUIPMENT FOR OPERATIONS ON ELECTRIC AND HYBRID VEHICLES** - Équipements pour opérations sur véhicules électriques & hybrides - Ausrüstung für den Betrieb von Elektro- und Hybridfahrzeugen

**FACE SHIELD WITH HEADBAND**  
- ÉCRAN FACIAL AVEC SERRE-TÊTE  
068018



**INSULATING GLOVES (T10)**  
- GANTS ISOLANTS (T10)  
068025



**25 pieces insulated tools 1000V** - Coffret de 25 outils isolés 1000V  
- Box mit 25 isolierten Werkzeugen 1000V  
066489

7/8/10/12/14/15/17/19/22 mm sockets - Douilles 7/8/10/12/14/15/17/19/22 mm	x 9
175 mm universal pliers in chrome vanadium - Pince universelle de 175 mm en chrome vanadium	x 1
Cutting pliers 150 mm in chrome vanadium - Pince coupante 150 mm en chrome vanadium	x 1
3/8" ratchet - Cluqiet en 3/8"	x 1
Extension 100 mm - Rallonge 100 mm	x 1
T-handle - Poignée en T	x 1
Open ended wrenches 7/8/10/12/14/17 mm - Clés plates à fourches 7/8/10/12/14/17 mm	x 6
Cable knife - Couteau pour câble	x 1
Phillips PhH1x100/PhH2x100 mm screwdriver - Tournevis Phillips PhH1x100/PhH2x100 mm	x 2
Flat screwdriver 5.5x125 / 4x100 mm - Tournevis plats 5.5x125/4x100 mm	x 2



**Kit for marking the area of intervention**  
- Kit pour le balisage de la zone d'intervention  
- Kennzeichnungsset für Hochvolt-Bereiche  
064409

Red and white warning pole - Balise de signalisation rouge et blanche	x 4
Red and white bounding line - Chaîne de délimitation rouge et blanche	x 1
Sign board "Danger, working area EHV" - Pancarte de signalisation "Danger, zone de travail VEH"	x 2



**TROUSER** - Pantalon - Hose



EN ISO 11611 Class 2-A1 & A2	98% cotton, 2% antistatic
EN ISO 11612 A1+A2-B1-C1-E3-F1	S (40/42) 046368
IEC 61482-2 Class 1-4kA	M (44/46) 046375
EN 14404 +A1 Type 2	L (48/50) 046382
	XL (52/54) 046399
	XXL (56/58) 046412

**JACKET** - Veste - Jacke



IEC 61482-2 Class 1-4kA	EN ISO 11612 A1+A2-B1-C1-E3-F1	EN 14404 +A1 Type 2
EN ISO 11611 Class 2-A1 & A2	EN 1149-5	
	98% cotton, 2% antistatic	
	S (40/42) 046313	
	M (44/46) 046320	
	L (48/50) 046337	
	XL (52/54) 046344	
	XXL (56/58) 046351	



★★★★★ **THEY TRUST US** ★★★★★

ILS NOUS FONT CONFIANCE

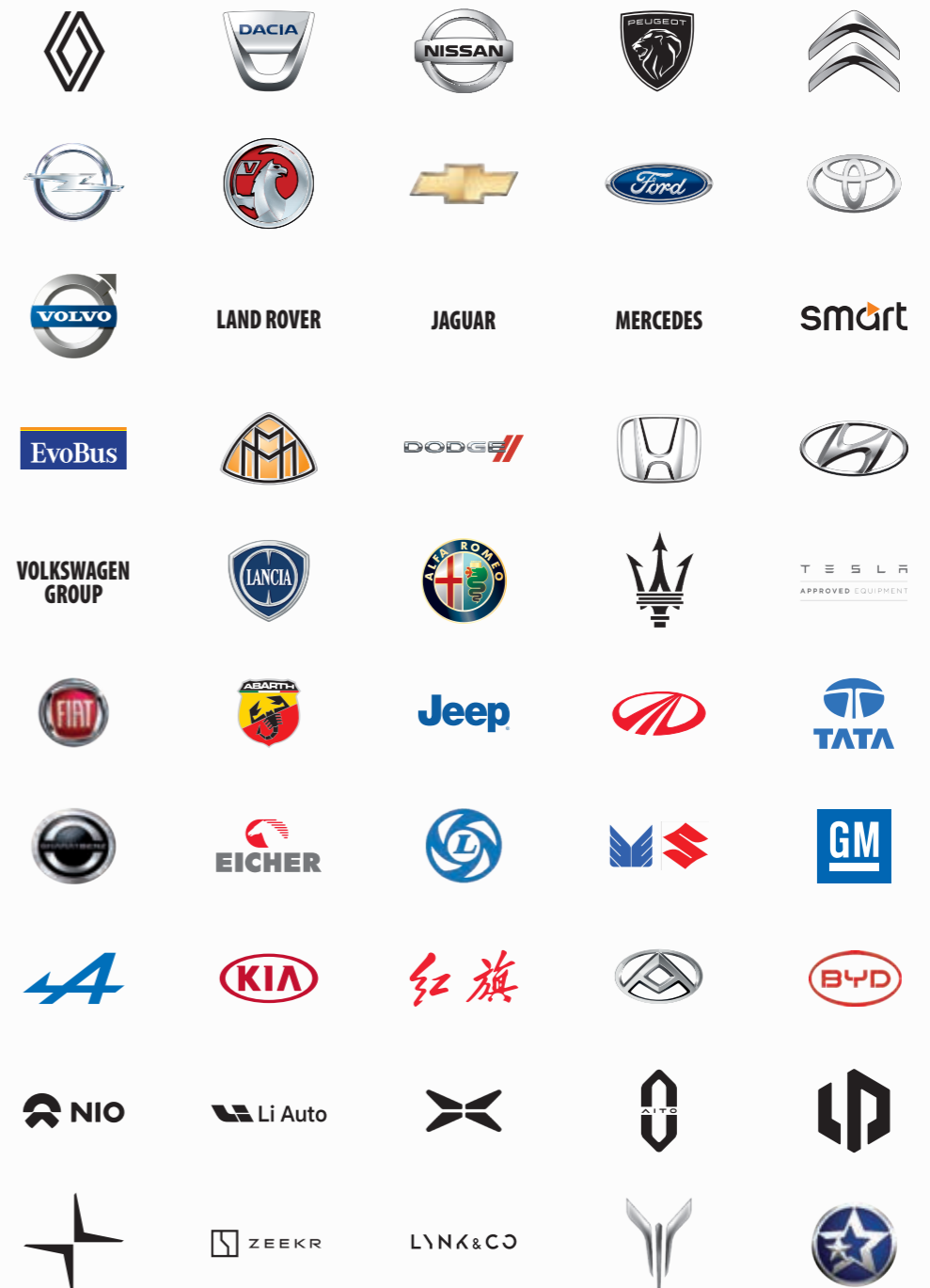



INVEST IN THE FUTURE



French manufacturer  
since 1964

2  
0  
2  
4

# Car Body Welding Systems

Catalogue Carrosserie  
Catalogo Carrozzeria  
Karosserie-Schweißtechnik Katalog  
Catálogo de Soldadura para Carrocería



LinkedIn  
 Youtube  
 WeChat  
 Facebook  
 Instagram

[www.gys.fr](http://www.gys.fr)



## GYS FRANCE

### HEADQUARTERS

1 rue de la Croix des Landes  
CS 54159  
53941 Saint-Berthevin - Cedex  
Laval - France  
Tel +33 2 43 01 23 60  
E-mail [service.client@gys.fr](mailto:service.client@gys.fr)



ZI, 134 bd des Loges  
53941 Saint-Berthevin  
Laval - France

### LOGISTIC CENTER

2 Rue Jean Dausset  
53810 Changé - France  
Tel +33 2 43 01 54 33



## GYS GERMANY

Professor-Wieler  
Straße 11  
52070 Aachen  
Deutschland

Tel +49 241/189-23-710  
Fax +49 241/189-23-719  
E-mail [aachen@gys.fr](mailto:aachen@gys.fr)



## GYS UK

Unit 3 - Great Central Way  
Rugby - Warwickshire  
CV21 3XH  
United Kingdom

Tel +44 1926 338 609  
Fax +44 1926 429 764  
E-mail [uk@gys.fr](mailto:uk@gys.fr)



## GYS ITALIA

Via Porta Est, 7  
30020 Marcon - VE  
Italia

Tel +39 041 53 21 565  
E-mail [italia@gys.fr](mailto:italia@gys.fr)



## GYS IBÉRICA

Avenida Pirineos 31  
Nave 9  
San Sebastian de los Reyes  
28703 Madrid  
España

Tel +34 917 409 790  
E-mail [iberica@gys.fr](mailto:iberica@gys.fr)



## GYS CHINA

Lot N°15  
6666 bd Songze  
201706 Qingpu  
Shanghai  
China

Tel +86 6221 4461  
Fax +86 5226 0067  
[www.gys-china.com.cn](http://www.gys-china.com.cn)  
E-mail  
[contact@gys-china.com.cn](mailto:contact@gys-china.com.cn)

## MARKETING

Podium de  
présentation  
- Display  
stand  
- Podest

**PODIUM 1**  
A : 45 cm  
B : 50 cm  
C : 50 cm  
063204

**PODIUM 2**  
A : 80 cm  
B : 50 cm  
C : 50 cm  
063211

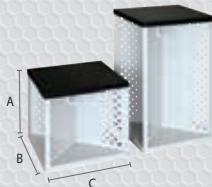

Oriflamme  
- Flag  
3 x 0,50 m  
098015



Barnum 3 x 3 m  
098022



Open barnum  
2 x 2 m  
098039



Linéaire de vente  
avec 2 étagères  
- Retail display  
space  
with 2 shelves  
- Lochwandregal  
mit 2 Böden  
(machines not  
included)  
060784



Distributed by

