

Your success counts

Batch Controller

with two stage control and receipt printer driver

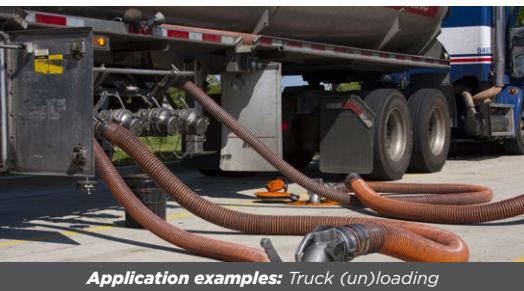

The F-Series is your first and safest choice for field mount indicators in safe and hazardous area applications. Especially in harsh weather conditions like rain, snow, salty atmospheres and temperatures between -40°C up to +80°C (-40°F up to 176°F).

Advantages

- Robust aluminum or stainless steel 316L field enclosure (IP67 / NEMA Type4X). It is so rugged, a truck can even stand on it!
- Intrinsically Safe available - ATEX and IECEx approval for gas and dust applications.
- Programming can be done by your own crew, with the sensible menu-driven structure, saving cost and irritation. Know one, know them all!
- Very diverse mounting possibilities: walls, pipes, panels or directly onto outdoor sensors!

Features

- Receipt printing function after each batch.
- Displays preset and running batch value simultaneously.
- Easy to enter a batch, print a receipt and control the process.
- Count-up and count-down function available.
- Self-learning overrun correction.
- No-flow monitoring.
- Selectable on-screen engineering units; volumetric or mass.
- Ability to process all types of signals: Sine wave (coil), NAMUR, NPN/PNP pulse, Reed-switch, Active pulse signals.
- Remote control input: Start / Pause / Stop.
- Two configurable control outputs: for two-stage control or one-stage control with scaled pulse output according to acc. total.
- Power req.: battery powered, 8 - 30V DC, 8 - 24V AC/DC or 115 - 230V AC.
- Sensor supply 3 / 8.2 / 12 / 24V DC.

Introduction

The F132 is a straight forward two stage batch controller with the unique function to send a “print receipt” command to a printer after every batch. The operator can easily enter a batch quantity, send an extra “print receipt” command or execute repeating batches. During the batch, the preset value is displayed as well as the batched (or remaining) quantity including the units of measurement. The automatic self-learning overrun correction ensures an accurate result after each batch. A wide selection of options further enhances the capabilities of this model, which includes Intrinsic Safety.

Printer communication

The “print receipt” command is processed through the ASCII data communication link (RS232 / RS485). Receipt printing functionality remains available for the Intrinsically Safe version (TTL). More receipt information on page 6.

Configuration

All configuration settings are accessed via a simple operator menu which can be password protected. Each setting is clearly indicated with an alphanumeric description, which avoids confusing abbreviations and baffling codes. Once familiar with one F-series product, you will be able to program all models in the series without a manual. All settings are safely stored in EEPROM memory in the event of sudden power failure.

Display

The display has large 17mm (0.67”) and 8mm (0.31”) digits which show the batched quantity and the preset value simultaneously. On-screen engineering units are easily configured from a comprehensive menu. A seven digit resettable “day total” is available as well as an eleven digit non-resettable accumulated total. All values are backed-up in EEPROM memory every minute.



Control outputs

Two outputs are available which can be configured to operate as two stage control for large batch quantities or as one stage control for smaller batches, where the second output is available as a scaled pulse output. The maximum output frequency is 500Hz. The output signals can be passive NPN, active PNP or isolated electromechanical relays.

No-flow

If there is a predefined time-out in the input signal, the no-flow alarm will be triggered. The F130 goes in pause-mode and the display will show: NO FLOW.

Hazardous areas

This model is ATEX and IECEx certified as Intrinsically Safe for gas applications with an allowed ambient temperature of -40°C to +70°C (-40°F to +158°F) and dust applications with an allowed ambient temperature of -40°C to +50°C (-40°F to +122°F). A flame proof Ex d enclosure with ATEX/IECEx certification is also available.



All info at a glance



Easy to install



Easy to program



Know one know them all!



Reliable



User-friendly

Overview application F132

The F-Series is your first and safest choice for field mount indicators in safe and hazardous area applications. Especially in harsh weather conditions like rain, snow, salty atmospheres and temperatures between -40°C up to +80°C (-40°F up to 176°F). Batching of small and /or large quantities, single or repeating batches where printed information is requested. Alternative models: F030, F130, F131, F136 or the N413 and N414 DIN panel mount batch controllers with numerical keypad.

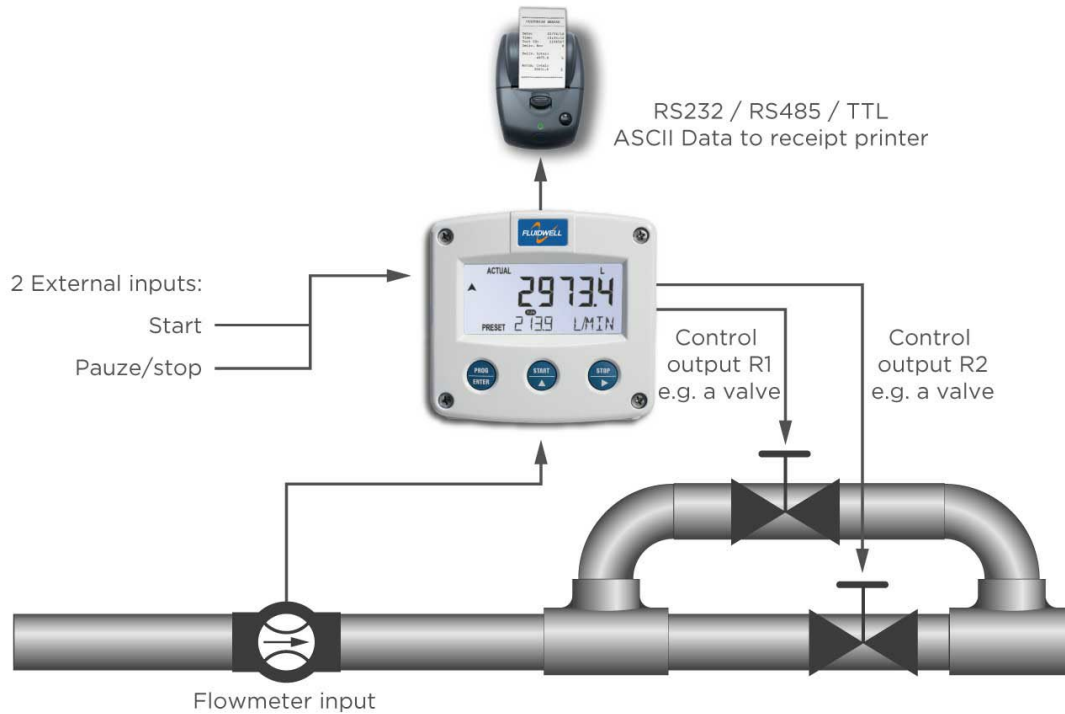

Signal input

The F132 accepts most pulse input signals for volumetric flow or mass flow measurement. For remote control, two inputs are available to start, pause and stop the batch process.

Type of signal	Resistance	Low Pass filter (LP)	Max. frequency	Max. frequency Low Pass filter (LP)	Min. amplitude P-P	Remark
NPN	100kΩ pull-up	100kΩ pull-up	6kHz Threshold 1.2V	1.2kHz		Open collector
REED	1MΩ pull-up	1MΩ pull-up	1.2kHz Threshold 1.2V	120Hz		
PNP	100KΩ pull-down	100KΩ pull-down	6kHz Threshold 1.2V	1.2kHz		
NAMUR	820Ω pull-down	-	4kHz	-		External power required
COIL LO	-	-			80mV _{pp}	Default sensitivity
COIL-HI					20mV _{pp}	Sensitive for interference!
COIL-HI (Type ZF)					10mV _{pp}	
ACTIVE 8.2V DC	3K9Ω		10kHz Threshold 4V			External power required
ACTIVE 12V DC	4KΩ		10kHz Threshold 6V			External power required
ACTIVE 24V DC	3KΩ		10kHz Threshold 12V			External power required

Enclosures

Various types of enclosures can be selected, all ATEX and IECEx approved. The F132 is supplied in an GRP panel mount enclosure as standard, which can be converted to an IP67 / NEMA Type4X GRP field mount enclosure by the addition of a back case. Most popular is our robust aluminum field mount enclosure which is also available with an extended backcover with undrilled preparation for direct meter mounting at the back side. It is so rugged, even a truck can stand on it! For the most challenging environments we have a durable high grade Stainless steel 316L enclosure. All enclosures have a IP67 / NEMA Type4X rating and EU or U.S. cable gland entry threads available.

Dimensions enclosures

Aluminum & GRP panel mount enclosure

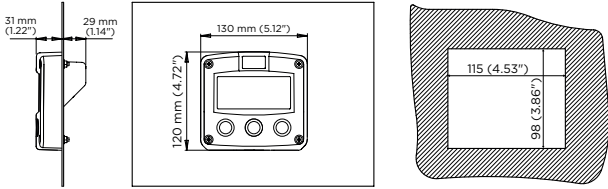

HB & HC enclosures

panel cut-out

Aluminum, GRP & Stainless steel 316L field mount enclosures

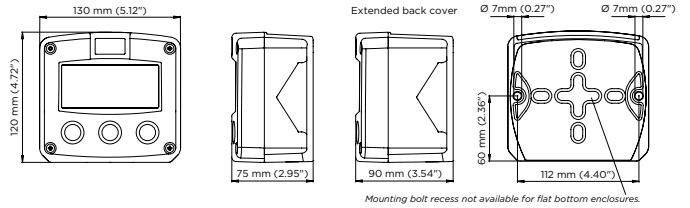

Mounting bolt recess not available for flat bottom enclosures.

Cable entries

Aluminum / Stainless Steel

GRP

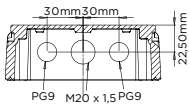

HA

HD

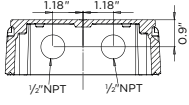

HL

HE

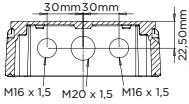

**HM
HSM**

HF

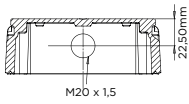

HN

HG

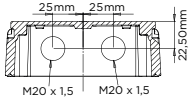

**HO
HSO**

HH

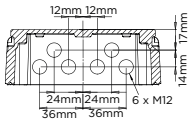

HP

HJ

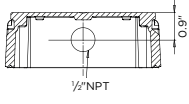

HT

HK

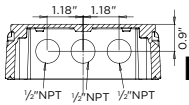

**HU
HSU**

Extended Aluminum

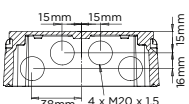

HV

HBM

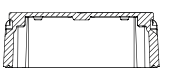

HZ

HBO



HBU

Flat bottom, no holes available.

Terminal connections

00	01	02	03	04	05	06	07	08	09	10	11	12	13	14	15	16	17	18	19	20	21	22	23	24	25	26	27	28	29	30	31				
POWER REQUIREMENT	CONTROL OUTPUT F2	CONTROL OUTPUT F1	POWER REQUIREMENT	FLOWMETER INPUT	ADDITIONAL INPUT	ADDITIONAL INPUT	PRINTER COMMUNICATION																												
PD.S. 24V AC	OK. active 24V DC	OK. active 24V DC	FX. Xi. 8..30V DC	P. spill	FR. Stop	FR. Start	DT.RS. 120V	DT.RS. 24V AC	OT. 12V	OT. 24V	OT. RS. 85.. 2 wire	OT. RS. 85.. 4 wire	OT. T.L. (Intrinsic Safety)	OT. T.L. (Intrinsic Safety)	DT.F. 12V	DT.F. 24V	DT.F. 12V	A	B	A	B	A	B	A	B	Y	Z	RXD	TXD	RXD	TXD				
				P. PNP	P. PNP	P. NPN																													
				P. mech. relay	OR. mech. relay																														

FB / PC battery powered internal long life Lithium battery

Configuration example F132-P-CH-OT-PB-(PX)-XX-ZX

Configuration example F132-P-CI-OR-PM-XX-ZX

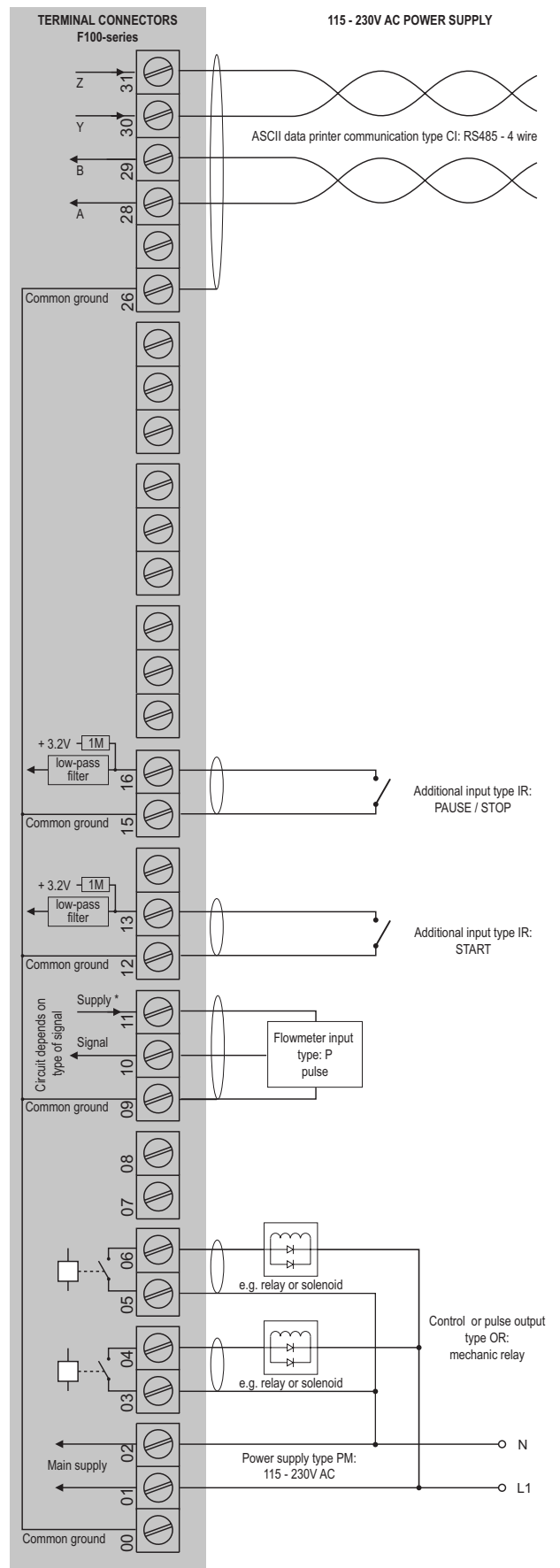
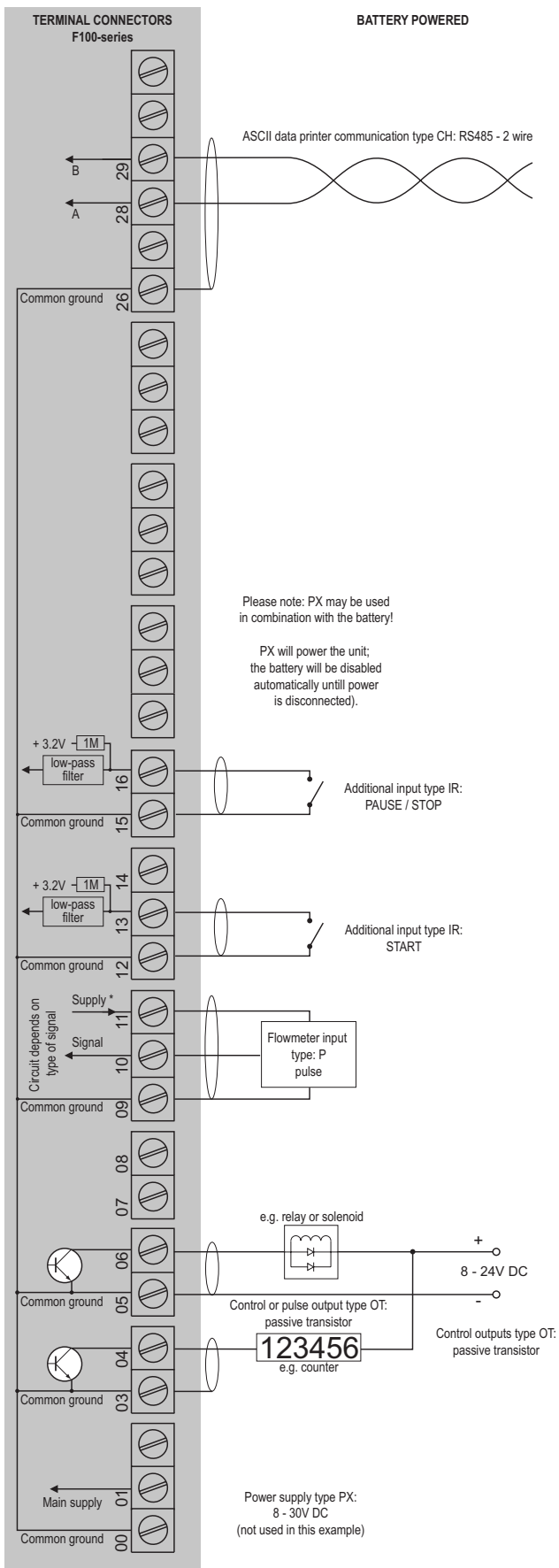

* For pulse type inputs: V_{ref} : 1.2V/3.0V available.- NO power output, available I_{supply} : <1mA. Note: using these ref. voltages at max. load, will reduce battery life significantly.

*Supply voltage: 3.2 / 8.2 / 12 / 24V DC to sensor

Printer accessories

An external printing device is necessary, below handheld and panel printers are optional available as accessory.



Handheld and panel printers

Receipt information

After each completed batch a receipt is printed on an external device. Additional receipts can be printed on demand. No back-up of the latest batch information in case of a power failure.

Standard information printed on the receipt:

- A date- and timestamp.
- Tagnumber.
- Number of completed batches
- Delivered total.
- Accumulated total.

Configurable information printed on the receipt:

- 16 character upper case text header.
- 1 to 9 empty lines before printing the receipt.
- 1 to 9 empty lines after printing the receipt.

Receipt example

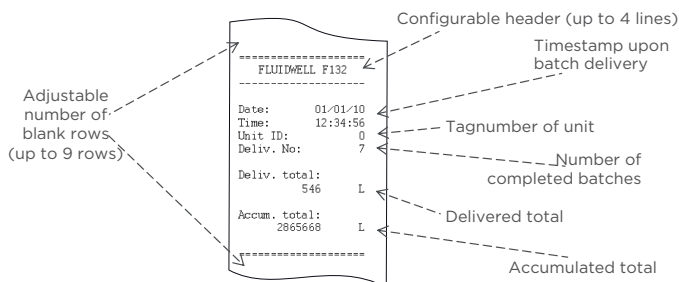

Hazardous area applications

The F132-XI has been certified according to ATEX and IECEx by DEKRA for use in Intrinsically Safe applications with an ambient temperature of -40°C to +70°C (-40°F to +158°F).

For equipment category Dust, zone 20 (1 D / EPL Da), the maximum ambient temperature is limited to 50°C (+122°F) and a maximum dust layer thickness of 200mm.

- The ATEX markings for gas and dust applications are:

Gas: **II 1 G Ex ia IIB/IIC T4 Ga.**
 Dust: **II 1 D Ex ia IIIC T₂₀₀ 100 °C Da.**

- The IECEx markings for gas and dust applications are:

Gas: **Ex ia IIC/IIB T4 Ga.**
 Dust: **Ex ia IIIC T₂₀₀ 100 °C Da.**

Besides the I.S. power supplies for the control outputs, it is allowed to connect up to two I.S. power supplies in IIB/IIIC applications or one in IIC applications. Consult the certificate for the maximum input and output values of the circuits. Full functionality of the F132 remains available, including two stage control and Modbus communication (type CT). Power supply type PD-XI offers a 8.2V sensor supply e.g. for one Namur sensor. An ATEX/IECEx approved flame proof Ex d enclosure is available as well. Please contact your supplier for further details.

Certificate of conformity KEMA 03ATEX1074 X

- IECEx DEK 11.0042X

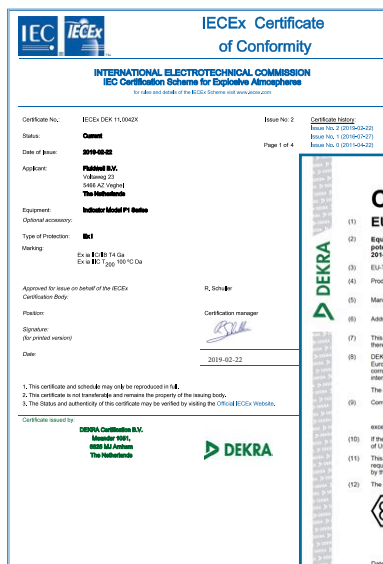

Configuration example IIB / IIIC and IIC - F132-P-(CT)-OT-(PX)-XI - Battery powered unit

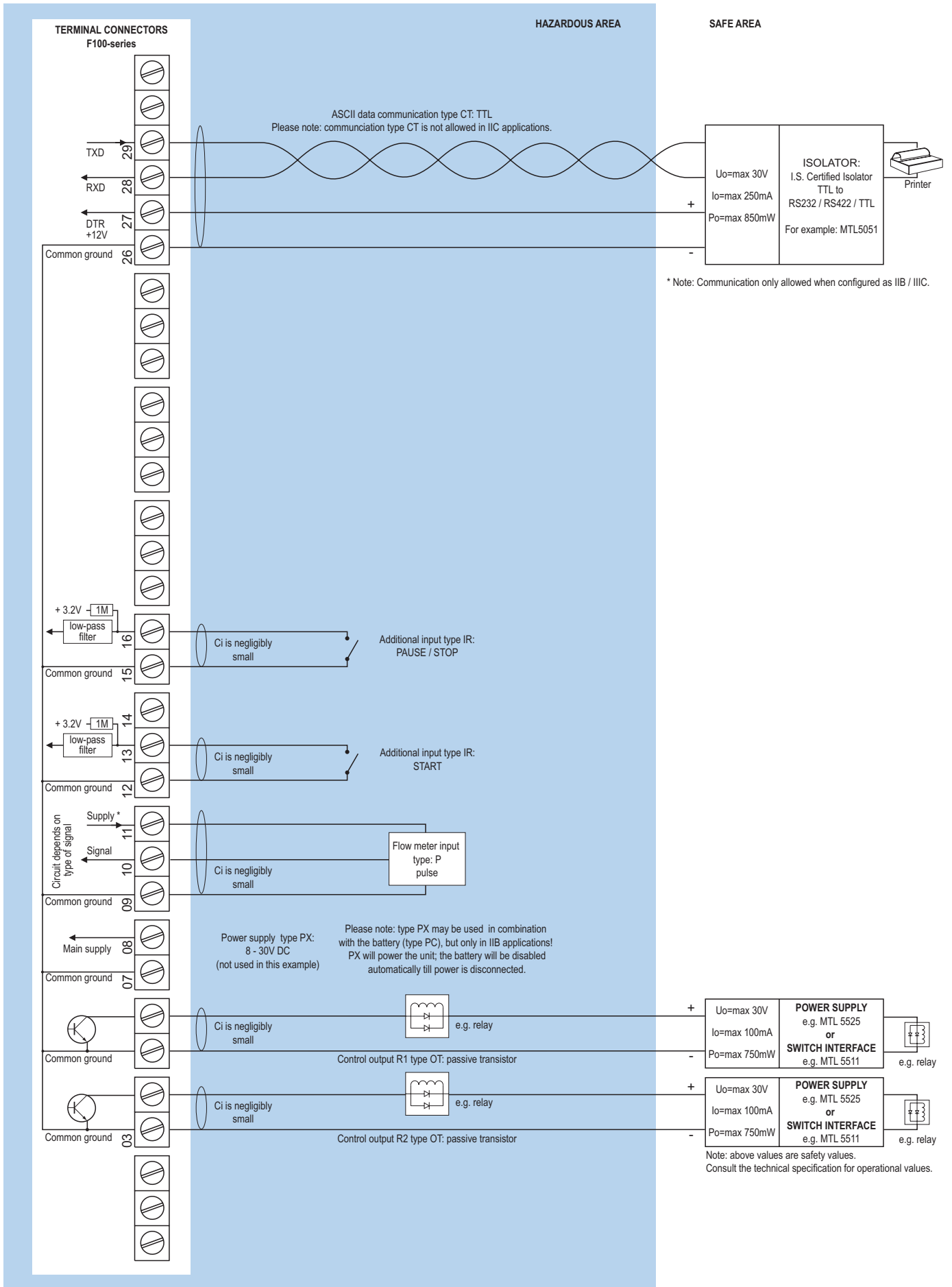

* For pulse type inputs: V_{ref} : 1.2V/3.0V available.- NO power output, available I_{supply} : <1mA.
Note: using these ref. voltages at max. load, will reduce battery life significantly.

Configuration example IIB / IIIC and IIC - F132-P-(CT)-OT-PX-XI - Basic power requirement 8 - 30V DC

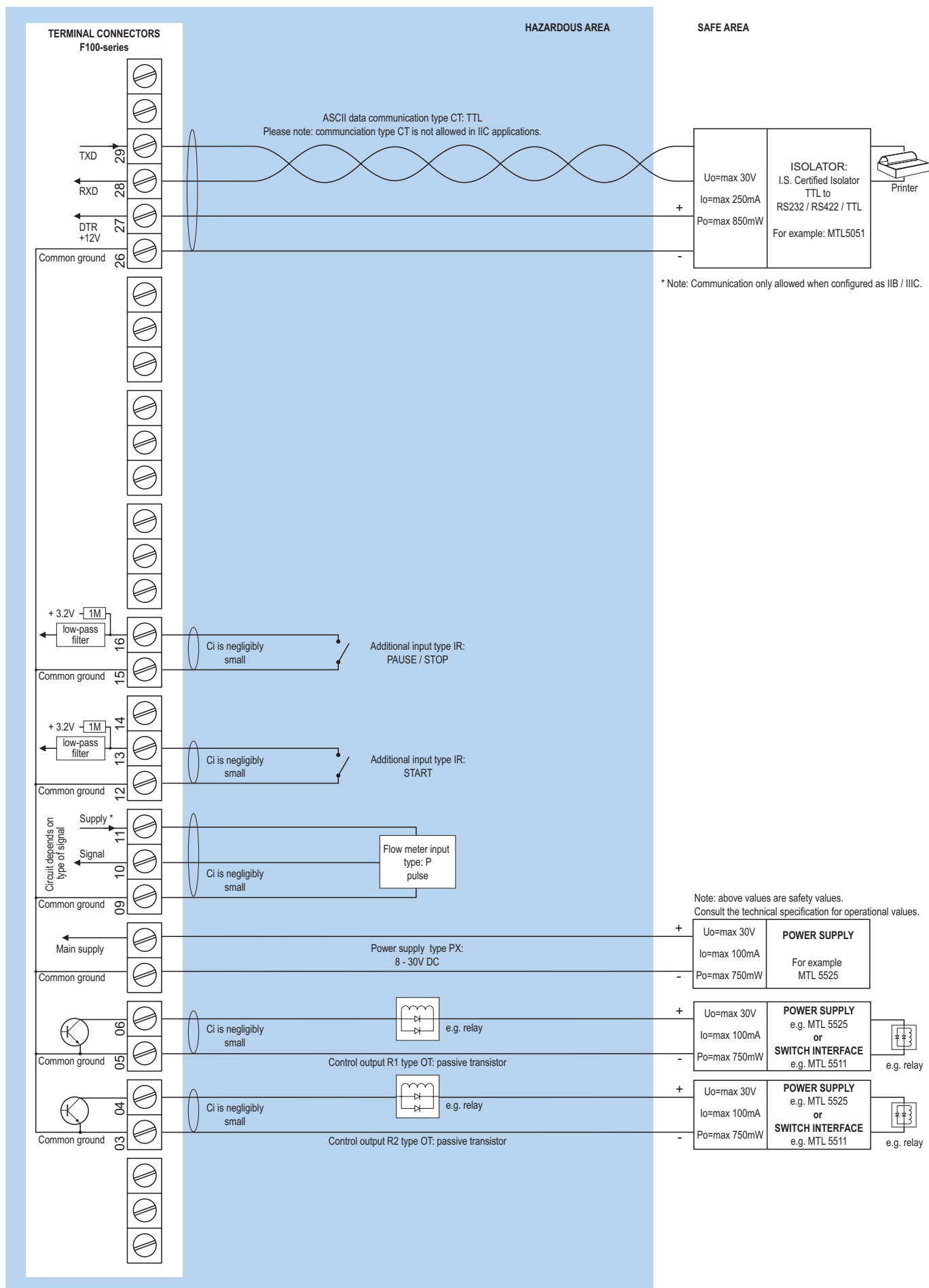

* For pulse type inputs: V_{ref} : 1.2V/3.0V available.- NO power output, available I_{supply} : <1mA.
Note: using these ref. voltages at max. load, will reduce battery life significantly.

Configuration example IIB / IIIC and IIC - F132-P-(CT)-OT-PD-XI - Power requirement 16 - 30V DC

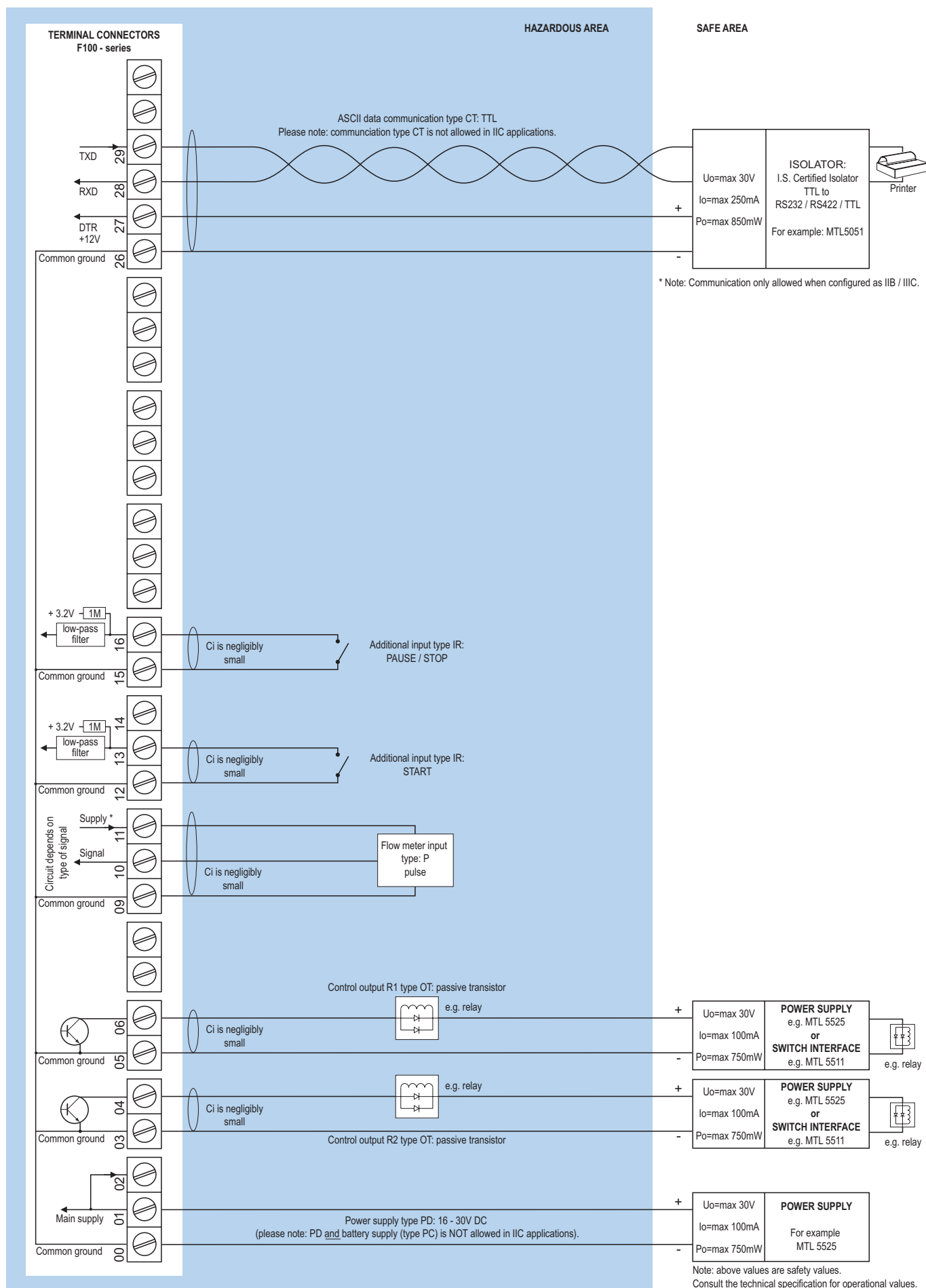

* Note power supply type PD: the supply voltage to pulse sensors is maximum 8.7V (Uo=max 8.7V Io=max 25mA Po=max 150mW).

Display

Type	High intensity reflective numeric and alphanumeric LCD, UV-resistant.
Dimensions	90 x 40mm (3.5" x 1.6").
Digits	Seven 17mm (0.67") and eleven 8mm (0.31") digits. Various symbols and measuring units.
Refresh rate	User definable: fast, 1sec, 3sec, 15sec, 30sec, off.
Option ZB	Transflective LCD with white LED-backlight. Intensity can be adjusted in the configuration menu. Good readings in full sunlight and darkness.
Note ZB	Only available for safe area applications.

Ambient temperature

Safe areas	-40°C to +80°C (-40°F to +176°F).
Intrinsically Safe	-40°C to +70°C (-40°F to +158°F).
Dust, zone 20	-40°C to +50°C (-40°F to +122°F).

Terminal connections

Type	Removable plug-in terminal strip. Wire max. 1.5mm ² and 2.5mm ² .
-------------	---

Data protection

Type	EEPROM backup of all settings. Backup of running totals every minute. Data retention at least 10 years.
Password	Configuration settings can be password protected.

Directives & Standards

EMC	Directive 2014/30/EU, FCC 47 CFR part 15.
Low voltage	Directive 2014/35/EU
RoHS	Directive 2011/65/EU
ATEX / IECEx	Directive 2014/34/EU, IEC 600079-0, IEC 60079-11.
IP & NEMA	EN 60529 & NEMA 250

Intrinsically Safe (Type XI)

ATEX	Gas: II 1 G Ex ia IIB/IIC T4 Ga. Dust: II 1 D Ex ia IIIC T ₂₀₀ 100 °C Da.
IECEX	Gas: Ex ia IIC/IIB T4 Ga. Dust: Ex ia IIIC T ₂₀₀ 100 °C Da.
Ambient Ta	-40°C to +70°C (-40°F to +158°F).
Dust, zone 20	-40°C to +50°C (-40°F to +122°F).

Explosion proof (Type XF)

ATEX/IECEX	Gas: II 2 G Ex db IIB+H2 T5 Gb. Dust: II 2 D Ex tb IIIC T80°C.
Protection	IP66
Type XF	Dimensions of enclosure: 300 x 250 x 200mm (11.8" x 9.9" x 7.9") L x H x D.
Weight	Appr. 15kg.

Enclosure

Window	Polycarbonate window.
Sealing	Silicone.
Control keys	Three industrial micro-switch keys. UV-resistant silicone keypad.

Panel mount enclosures

Dimensions	130 x 120 x 60mm (5.12" x 4.72" x 2.36") - W x H x D.
Panel cut-out	115 x 98mm (4.53" x 3.86") L x H.
Type HB	Die-cast aluminum panel mount enclosure IP65 / NEMA Type4X.
Weight	600 gr.
Type HC	GRP panel mount enclosure IP65 / NEMA Type4X, UV-resistant and flame retardant.
Weight	450 gr.
Type HSB	Die-cast stainless steel 316L IP67 / NEMA Type4X.
Weight	1150gr.

GRP wall / field mount enclosures

General	GRP wall/field mount enclosure IP67 / NEMA Type4X, UV-resistant and flame retardant.
Dimensions	130 x 120 x 75mm (5.12" x 4.72" x 2.95") - W x H x D.
Weight	600 gr.
Type HD	Cable entry: no holes.
Type HE	Cable entry: 2 x Ø 16mm and 1 x Ø 20mm.
Type HF	Cable entry: 1 x Ø 22mm (7/8").
Type HG	Cable entry: 2 x Ø 20mm.
Type HH	Cable entry: 6 x Ø 12mm.
Type HJ	Cable entry: 3 x Ø 22mm (7/8").
Type HK	Flat bottom, cable entry: no holes.

Aluminum wall / field mount enclosures

General	Die-cast aluminum wall/field mount enclosure IP67 / NEMA Type4X with 2-component UV-resistant coating. Extended back cover available with undrilled preparation for direct meter mounting.
Dimensions	130 x 120 x 75mm (5.12" x 4.72" x 2.95") - W x H x D. 130 x 120 x 90mm (5.12" x 4.72" x 3.54") - W x H x D.
Weight	1100 gr. / extended enclosure: 1310 gr.
Type HA	Cable entry: 2 x PG9 and 1 x M20.
Type HL	Cable entry: 2 x 1/2" NPT.
Type HM/HBM	Cable entry: 2 x M16 and 1 x M20.
Type HN	Cable entry: 1 x M20.
Type HO/HBO	Cable entry: 2 x M20.
Type HP	Cable entry: 6 x M12.
Type HT	Cable entry: 1 x 1/2" NPT.
Type HU/HBU	Cable entry: 3 x 1/2" NPT.
Type HV	Cable entry: 4 x M20.
Type HZ	Cable entry: no holes.

Stainless steel 316L wall / field mount enclosures

General	Die-cast stainless steel 316L wall / field mount enclosure with flat bottom. IP67 / NEMA Type4X.
Dimensions	130 x 120 x 75mm (5.12" x 4.72" x 2.95") - W x H x D.
Weight	2700 gr.
Type HSM	Cable entry: 2 x M16 + 1 x M20.
Type HSO	Cable entry: 2 x M20.
Type HSU	Cable entry: 3 x 1/2" NPT.

Signal inputs - Flowmeter

Type P	Coil / sine wave (HI: 20mVpp or LO: 80mVpp - sensitivity selectable), NPN/PNP, open collector, reed switch, Namur, active pulse signals 8 - 12 and 24V DC.
Frequency	Minimum 0Hz - maximum 6kHz for total and flow rate. Maximum frequency depends on signal type and internal low-pass filter. E.g. reed switch with low-pass filter: max. frequency 120Hz.
K-Factor	0.000010 - 9,999,999 with variable decimal position.
Low-pass filter	Available for all pulse signals.
Option ZF	coil sensitivity 10mVpp.

Additional inputs

Function	Remote control: Two terminal inputs to start, pause and stop the batch process.
Type IR	Internally pulled-up switch contact - NPN.
Duration	Minimum pulse duration 100msec.

Signal outputs - Digital output

Function	User defined: batch process one or two stage control - scaled pulse output according the running batch or according accumulated total.
Frequency	Max. 500Hz. Pulse width user definable between 0.001 second up to 9.999 seconds.
Type OA	Two active 24V DC transistor outputs (PNP); max. 50mA per output (requires -PD, PF, PM or PX). Requires min. 24V power supply
Type OR	Two electro-mechanical relay outputs isolated max. switch power 230V AC (N.O.) - 0.5A per relay (requires PF or PM).
Type OT	Two passive transistor outputs (NPN) - not isolated. Max. 50V DC - 300mA per output.

Signal outputs - Communication option

Function	Send a "print receipt" command after every batch.
Protocol	Modbus RTU.
Speed	1200 - 2400 - 4800 - 9600 baud.
Addressing	Maximum 255 addresses.
Type CB	RS232
Type CH	RS485 2-wire
Type CI	RS485 4-wire
Type CT	TTL Intrinsically Safe.

Mounting accessories

ACF02	Stainless steel wall mounting kit.
ACF05	Stainless steel pipe mounting kit (worm gear clamps not included).
ACF06	Two stainless steel worm gear clamps Ø 44 - 56mm.
ACF07	Two stainless steel worm gear clamps Ø 58 - 75mm.
ACF08	Two stainless steel worm gear clamps Ø 77 - 95mm.
ACF09	Two stainless steel worm gear clamps Ø 106 - 138mm.
ACF11	Swivel with 25° movement from center axis for direct flowmeter mounting: 1" NPT to 1/2" NPT.

Cable glands

ACF20	For HA enclosure, includes O-rings.
ACF25	For HE enclosure, includes locknuts and O-rings.
ACF26	For HF enclosure, includes locknuts and O-rings.
ACF27	For HG enclosure, includes locknuts and O-rings.
ACF28	For HH enclosure, includes locknuts and O-rings.
ACF29	For HJ enclosure, includes locknuts and O-rings.
ACF32	For HM enclosure, includes O-rings.
ACF33	For HN enclosure, includes O-rings.
ACF34	For HO enclosure, includes O-rings.
ACF35	For HP enclosure, includes O-rings.
ACF39	For HT enclosure, includes O-rings.
ACF40	For HU enclosure, includes O-rings.

Blind plugs

ACF50	For HA enclosure, includes O-rings.
ACF55	For HE enclosure, includes locknuts and O-rings.
ACF56	For HF enclosure, includes locknuts and O-rings.
ACF57	For HG enclosure, includes locknuts and O-rings.
ACF58	For HH enclosure, includes locknuts and O-rings.
ACF59	For HJ enclosure, includes locknuts and O-rings.
ACF62	For HM enclosure, includes O-rings.
ACF63	For HN enclosure, includes O-rings.
ACF64	For HO enclosure, includes O-rings.
ACF65	For HP enclosure, includes O-rings.
ACF69	For HT enclosure, includes O-rings.
ACF70	For HU enclosure, includes O-rings.

Intrinsically Safe isolators

ACG01	MTL5511 - One channel pulse or switch output transfer from hazardous area to safe area.
ACG02	MTL5525 - One channel power supply from safe area to hazardous area (e.g. to power the unit with PD or to power a switching or analog device in hazardous area).
ACG03	MTL5541 - One channel 4 - 20mA repeater from hazardous area to safe area.
ACG04	MTL 5051 - Bi-direction serial-data-isolator (for Modbus communication).
ACG05	MTL5516C - Two channel pulse or switch output transfer from hazardous area to safe area.
ACG06	MTL5513 - One channel pulse or switch output transfer from hazardous area to safe area.
ACG07	MTL5546Y - One channel isolated driver bringing 4 - 20mA from safe area to hazardous area, HART transparent, OCD.

Power requirements

Type AP	Analog output loop powered, 8 - 30V DC. Power consumption max 0.5 Watt.
Type PB	Long life Lithium battery - life-time depends upon settings and configuration - up to 5 years. (requires PD or PX)
Type PC	Intrinsically Safe long life lithium battery life-time depends upon settings and configuration - up to 5 years. (requires XI and PD or PX)
Type PD	8 - 24V AC / DC \pm 10%. Power consumption max. 5W.
Type PD-XI	16 - 30V DC power consumption max. 1W.
Type PF	24V AC / DC \pm 10%. Power consumption max. 15W.
Type PM	115 - 230V AC \pm 10%. Power consumption max. 15W.
Type PX	8 - 30V DC. Power consumption max. 0.75W.
Type ZB	12 - 30V DC \pm 10%. Power consumption max. 1.5W.
Note PB/PF/PM	Not available Intrinsically Safe.
Note PF/PM	The total consumption of the sensors and outputs may not exceed 400mA @ 24V.
Note XI	For Intrinsically Safe applications, consult the safety values in the certificate.

Sensor excitation

Type PB/PC/PX	3V DC for pulse signals and 1.2V DC for coil pick-up.
Note PB/PC/PX	This is not a real sensor supply. Only suitable for sensors with a very low power consumption like coils (sine wave) and reed-switches.
Type PD	1.2 / 3 / 8.2 / 12 / 24V DC - max. 50mA @ 24V DC. U_{max} sensor is 2V below U_{supply}
Type PD-XI	1.2 / 3 / 8.2V DC - max. 7mA @ 8.2V DC and mains power supply voltage (as connected to terminal 1).
Note PD-XI	In case PD-XI and signal A: the sensor supply voltage is according to the power supply voltage connected to terminal 1. Also terminal 2 offers the same voltage.
Type PF / PM	1.2 / 3 / 8.2 / 12 / 24V DC - max. 400mA @ 24V DC.

Operator functions

Displayed info	<ul style="list-style-type: none"> • Preset value - can be entered by the operator. • Batched quantity or remaining quantity.. • Total and accumulated total • Nr. of batches. • Reprint the last receipt. • No-flow alarm.
-----------------------	---

Preset and total

Digits	7 digits.
Units	L, m ³ , GAL, USGAL, kg, lb, bbl, no unit.
Decimals	0 - 1 - 2 or 3.
Note	Total can be reset to zero.

Accumulated total

Digits	11 digits.
Units / decimals	According to selection for total.
Note	Can not be reset to zero.

Printer ordering information

ACP01	Ap 1300 - Thermal portable printer (incl. cables and battery charger).
ACP02	Ap 1400 - Thermal panel printer with standard 9V DC to 36V DC power supply (incl. cables).
ACP03	Ap 1400 - Thermal panel printer with external 100 - 240V AC power supply (incl. cables).

		Description	
Model	F132	Batch controller with two stage control and receipt printer driver.	
Input	P	Pulse input, e.g., coil, npn, pnp, namur, reed-switch.	
Communication	CB	Printer driver RS 232 - ASCII data - requires XX.	
	CH	Printer driver RS 485 - 2wire - ASCII data - requires XX.	
	CI	Printer driver RS 485 - 4wire - ASCII data - requires XX.	
	CT	Intrinsically Safe TTL - ASCII data - requires XI.	
	CX	No communication, ticket printing is not possible.	
Enclosures	HB	Aluminum panel mount enclosure.	
	HC	GRP panel mount enclosure.	
	HSB	Stainless steel 316L panel mount enclosure.	
	HD	GRP field mount - Cable entry: no holes.	
	HE	GRP field mount - Cable entry: 2 x Ø 16mm & 1 x Ø 20mm.	
	HF	GRP field mount - Cable entry: 1 x Ø 22mm (7/8").	
	HG	GRP field mount - Cable entry: 2 x Ø 20mm.	
	HH	GRP field mount -Cable entry: 6 x Ø 12mm.	
	HJ	GRP field mount - Cable entry: 3 x Ø 22mm (7/8").	
	HK	GRP field mount - Flat bottom, cable entry: no holes.	
	HA	Aluminum field mount - Cable entry: 2 x PG9 + 1 x M20.	
	HL	Aluminum field mount - Cable entry: 2 x 1/2"NPT.	
	HM	Aluminum field mount - Cable entry: 2 x M16 + 1 x M20.	
	HN	Aluminum field mount - Cable entry: 1 x M20.	
	HO	Aluminum field mount - Cable entry: 2 x M20.	
	HP	Aluminum field mount - Cable entry: 6 x M12.	
	HT	Aluminum field mount - Cable entry: 1 x 1/2"NPT.	
	HU	Aluminum field mount - Cable entry: 3 x 1/2"NPT.	
	HV	Aluminum field mount - Cable entry: 4 x M20.	
	HZ	Aluminum field mount - Cable entry: no holes.	
	HBM	Extended Alu. field/meter mount - Cable entry: 2 x M16 + 1 x M20.	
	HBO	Extended Alu. field/meter mount - Cable entry: 2 x M20.	
	HBU	Extended Alu. field/meter mount - Cable entry: 3 x 1/2"NPT.	
	HSM	Stainless steel 316L field mount - Cable entry: 2 x M16 + 1 x M20.	
	HSO	Stainless steel 316L field mount - Cable entry: 2 x M20.	
	HSU	Stainless steel 316L field mount - Cable entry: 3 x 1/2"NPT.	
	Additional	IR	Remote control input to start, pause or stop.
	Digital output	OA	Two active transistor outputs- requires XX and PD, PF, PM or PX.
OR		Two mechanical relay outputs - requires XX and PF or PM.	
OT		Two passive transistor outputs.	
Power	PD	8 - 24V AC/DC + sensor supply - with XI: 16 - 30V DC.	
	PF	24V AC/DC + sensor supply - requires XX.	
	PM	115 - 230V AC + sensor supply - requires XX.	
	PX	Basic power supply 8 - 30V DC.	
Battery	PB	Additional lithium battery powered (optional) - requires XX and PD or PX.	
	PC	Additional lithium battery powered (optional) - Intrinsically safe - requires XI, and PD or PX.	
Hazardous	XI	Intrinsically safe, according ATEX and IECEx.	
	XF	Ex d enclosure - 3 keys according ATEX and IECEx.	
	XX	Safe area only, according CE / UKCA.	
Options	ZB	Backlight - requires XX.	
	ZF	Coil input 10mVpp.	
	ZX	No options.	

The **bold** marked text contains the standard configuration: F132-P-CX-HC-IR-OT-PX-XX-ZX.