



O & M Manual



E12-15

High Level NH₃ Gas Transmitter

Home Office

Analytical Technology, Inc.
6 Iron Bridge Drive
Collegeville, PA 19426
Phone: 800-959-0299
610-917-0991
Fax: 610-917-0992
Email: sales@analyticaltechnology.com
Web: www.Analyticaltechnology.com

European Office

ATI (UK) Limited
Unit 1 & 2 Gatehead Business Park
Delph New Road, Delph
Saddleworth OL3 5DE
Phone: +44 (0)1457-873-318
Fax: + 44 (0)1457-874-468
Email: sales@atiuk.com

TABLE OF CONTENTS

TABLE OF FIGURES	2
SPECIFICATIONS	3
INTRODUCTION	4
Features.....	4
MEASUREMENT PRINCIPLE	5
INSTALLATION	6
Warm-up.....	12
Normal Operation	12
Calibration.....	13
MAINTENANCE	14
SPARE PARTS LIST	15

TABLE OF FIGURES

FIGURE 1 - SENSOR DIMENSIONAL / CONNECTION DIAGRAM	7
FIGURE 2 - SENSOR DIMENSIONAL DRAWING - FLOWCELL TYPE	8
FIGURE 3 - TYPICAL WIRING DIAGRAM E12-15 TO B14 RECEIVER	9
FIGURE 4 - TYP. DIAGRAM E12-15 TO 24V UNIVERSAL P/S TO B14 RECEIVER	10
FIGURE 5 - E12-15 W/12V TO 24V CONVERTER AND BATTERY BACKUP	11

SPECIFICATIONS

Detection Method:	Diffusion Optional sample draw
Output (analog):	4-20 mA (Source type), max. 1000 Ohm load at 24 VDC supply voltage
Response Time:	T50 < 15 seconds T90 < 30 seconds
Construction:	Sensor housing is stainless steel. (SEC 5000) Class 1, Division 1, Groups B, C and D Ingress rating: NEMA 4X (IP66)
RFI/EMI Protection:	Tested to operate correctly in the presence of a 5 watt radio operated within 3 feet
Accuracy:	+/- 3% LFL, 0 to 50% of full scale +/- 5% LFL, 51 to 100% of full scale
Operating Temp.	-40° to +70°C at 0 to 99% RH (non-condensing)
Operating Voltage:	18 – 32 VDC
Power Consumption:	Maximum 5.1 W
Current Draw:	Average: 210 mA at 24 VDC Peak: 400 mA

INTRODUCTION

The E12-15 Infrared gas transmitter is a microprocessor based intelligent gas sensor that continuously monitors ammonia gas in the % level up to the Lower Explosive Limit (LEL). It is ideally suited for use in harsh environments and where the cost of required maintenance for conventional catalytic sensors is prohibitive. The Infrared gas sensor will perform reliably in the presence of silicone and other catalytic poisoning agents and can also operate in oxygen free environments or where high background gas levels are present. There are no known poisons that affect this technology.

The E12-15 is a stand-alone device providing a continuous 4 to 20 mA output.

Features

- Requires no routine calibration to ensure proper operation.
- Continuous self-test automatically indicates a fault, with fail to safe operation.
- A multi-layered filtering system protects optics from dirt and water ingress.
- Straight optical path eliminates the need for reflective surfaces, such as mirrors or beam splitters.
- Performs well in the presence of high concentrations or constant background levels of hydrocarbons and in oxygen depleted atmospheres.
- Immune to poisoning and etching.
- Standard 4 to 20 mA output (current source)
- Explosion proof housing designed for harsh environments.
- Smart Calibration AutoAC™ circuit.

MEASUREMENT PRINCIPLE

The E12-15 gas transmitter uses infrared absorption technology for detecting Ammonia gas. Gases absorb infrared light only at certain wavelengths. The concentration of a gas can be measured by the difference of two channels (wavelengths), a reference and a measurement channel. The E12-15 uses a collimated infrared light source that passes through a waveguide. At the end of the waveguide is a dual channel receiver. The dual channel receiver measures the intensity of two specific wavelengths, one at an absorption wavelength and another outside of the absorption wavelength. The gas concentration is determined by a comparison of these two values.

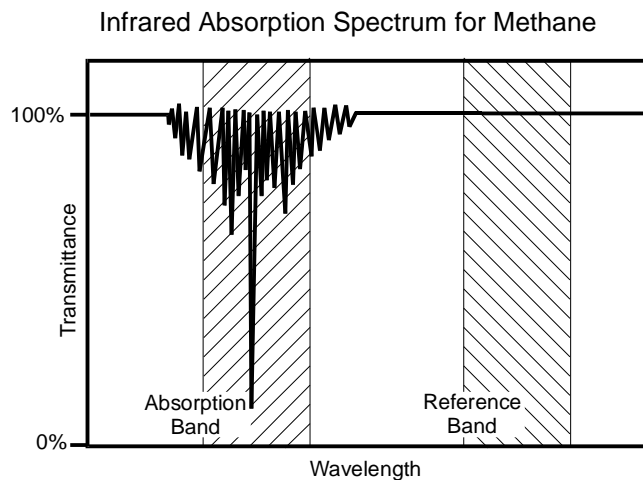

The dual channel receiver is a single wafer, double filtered, dual receiver with an internal optical barrier. The elements are perfectly matched resulting in overall stability and superior performance throughout the entire temperature range. Using a dual channel receiver there is no need to use any special lenses or beam splitters to achieve the different measurement bands.

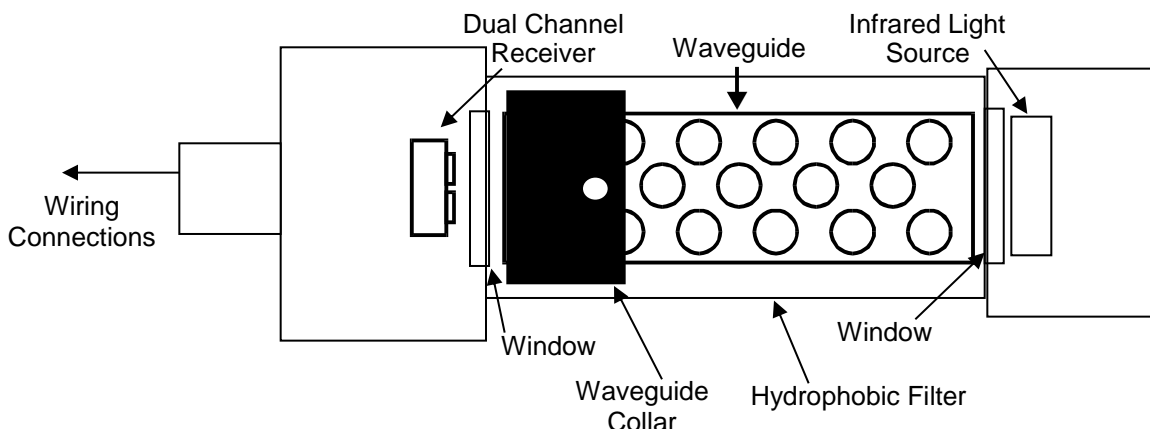

INSTALLATION

The first step in the installation process is to establish a mounting location for the transmitter. Select a location that is typical of the atmosphere to be monitored or close to the anticipated source of a dangerous gas.

It is very important that the E12-15 be properly located to enable it to provide maximum protection. The most effective number and placement of sensors vary depending on the conditions of the application. When determining where to locate sensors the following factors should be considered.

- What are the characteristics of the gas that is to be detected? Is it lighter or heavier than air? If it is lighter than air the sensor should be placed above the potential gas leak. Place the sensor close to the floor for gases that are heavier than air or for vapors resulting from flammable liquid spills. Note that air currents can cause a gas that is heavier than air to rise. In addition, if the temperature of the gas is hotter than ambient air or mixed with gases that are lighter than air, it could also rise.
- How rapidly will the gas diffuse into the ambient air? Select a location for the sensor that is close to the anticipated source of a gas leak.
- Wind or ventilation characteristics of the immediate area must also be considered. Movement of air may cause gas to accumulate more heavily in one area than in another. The transmitter should be placed in the areas where the most concentrated accumulation of gas is anticipated. For outdoor applications with strong wind conditions, it may require the sensors to be mounted closer together and on the down wind side, to the anticipated area of a gas leak. Also take into consideration for indoor applications, the fact that many ventilation systems do not operate continuously.
- The sensor should be accessible for maintenance.
- Excessive heat or vibration can cause premature failure of any electronic device and should be avoided if possible.
- Follow all national and local installation codes and practices.

The transmitter has a $\frac{3}{4}$ " NPT threaded connector for mounting to a junction box. ATI can provide a junction box with terminals for this purpose.

A user-supplied junction box can be used providing it has the appropriate sized NPT conduit entries. The junction box must be suitable for use in the application and location in which it is being installed. After the device has been installed, a calibration is required. Refer to the Calibration section of this manual.

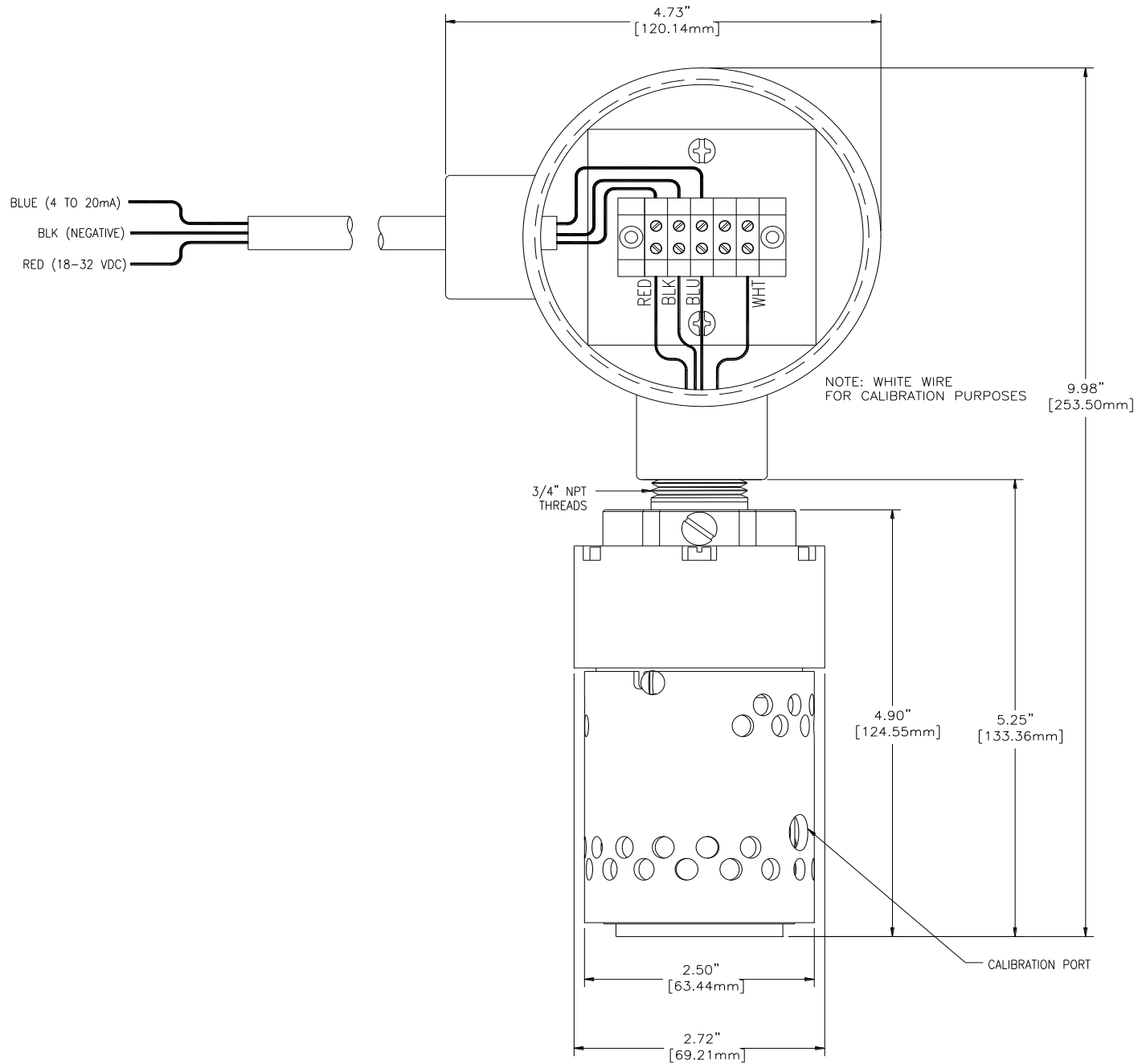

Figure 1 - Sensor Dimensional / Connection Diagram

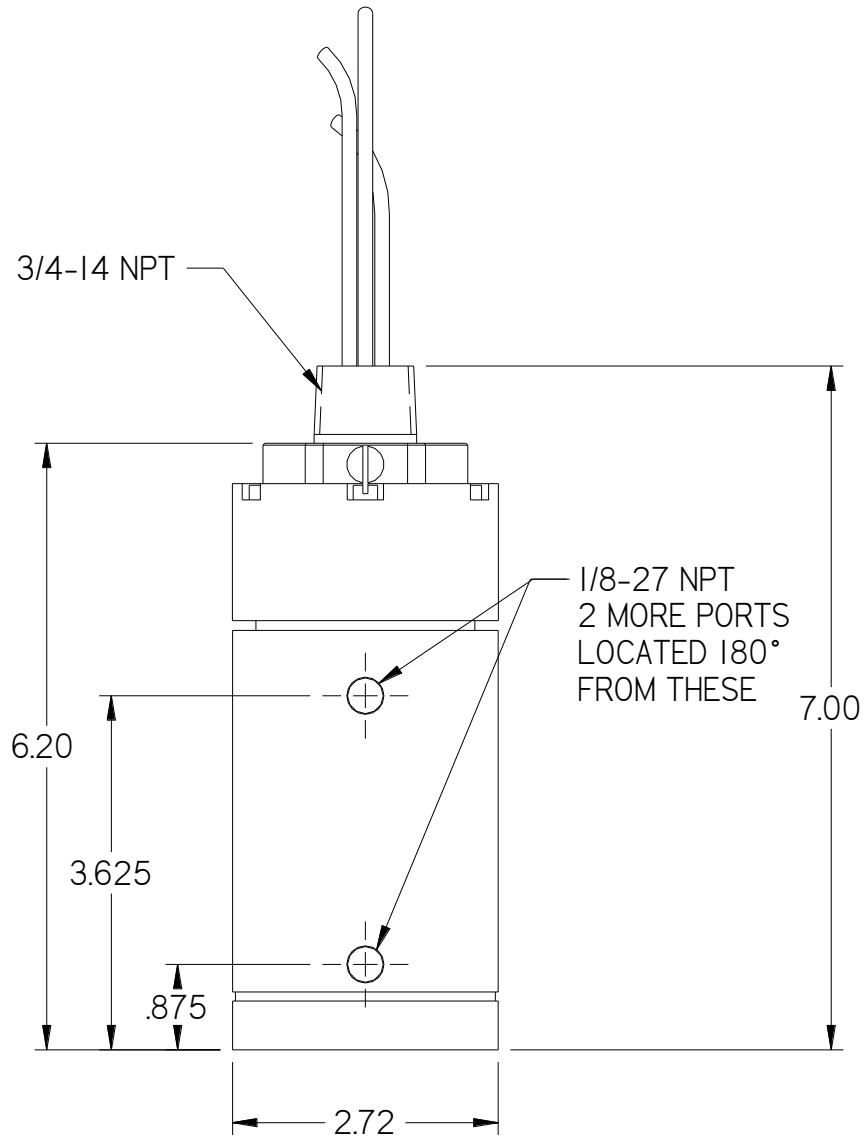

Figure 2 - Sensor Dimensional Drawing - Flowcell Type

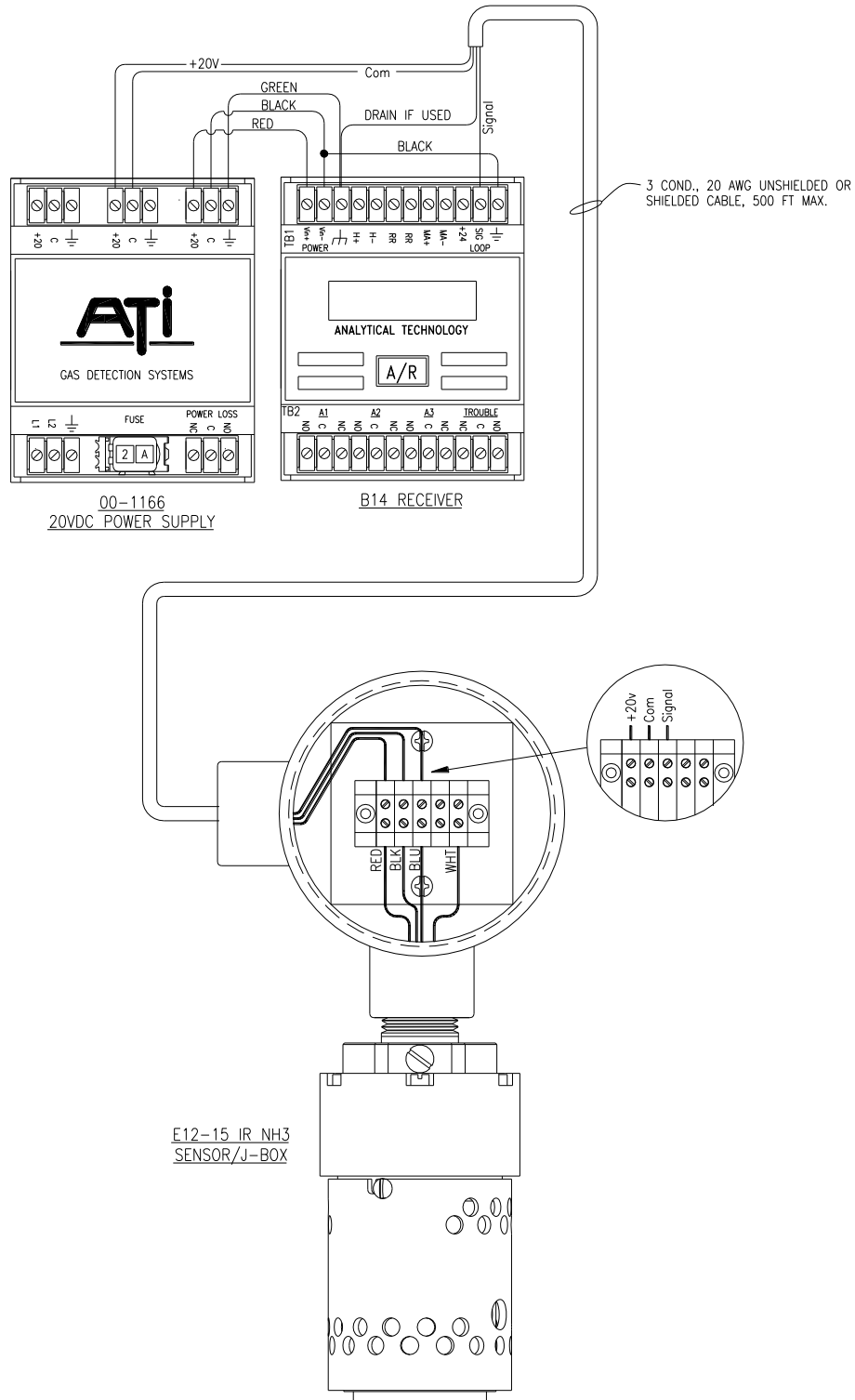

Figure 3 - Typical Wiring Diagram E12-15 to B14 Receiver

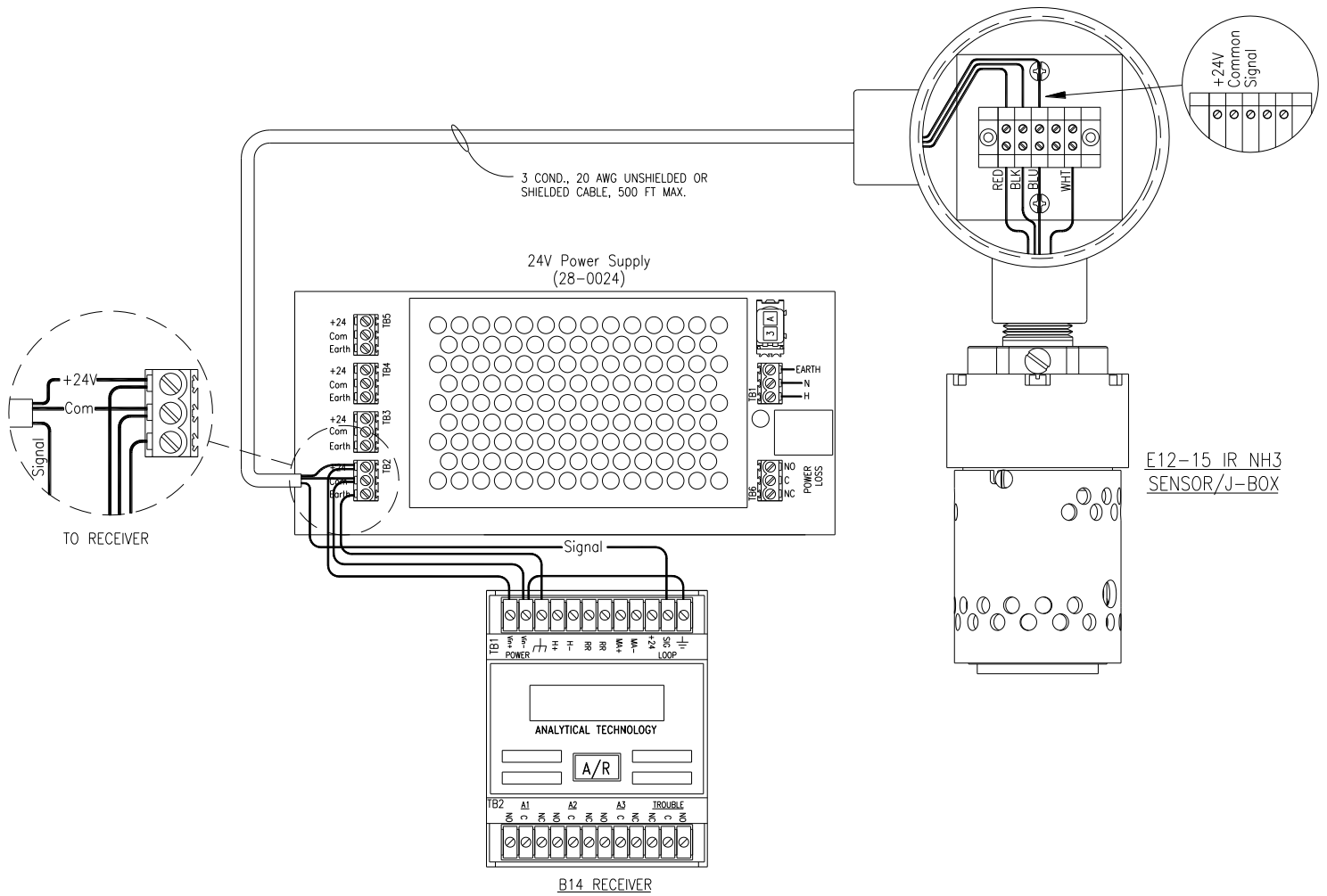

Figure 4 - Typ. Diagram E12-15 to 24V Universal P/S to B14 Receiver

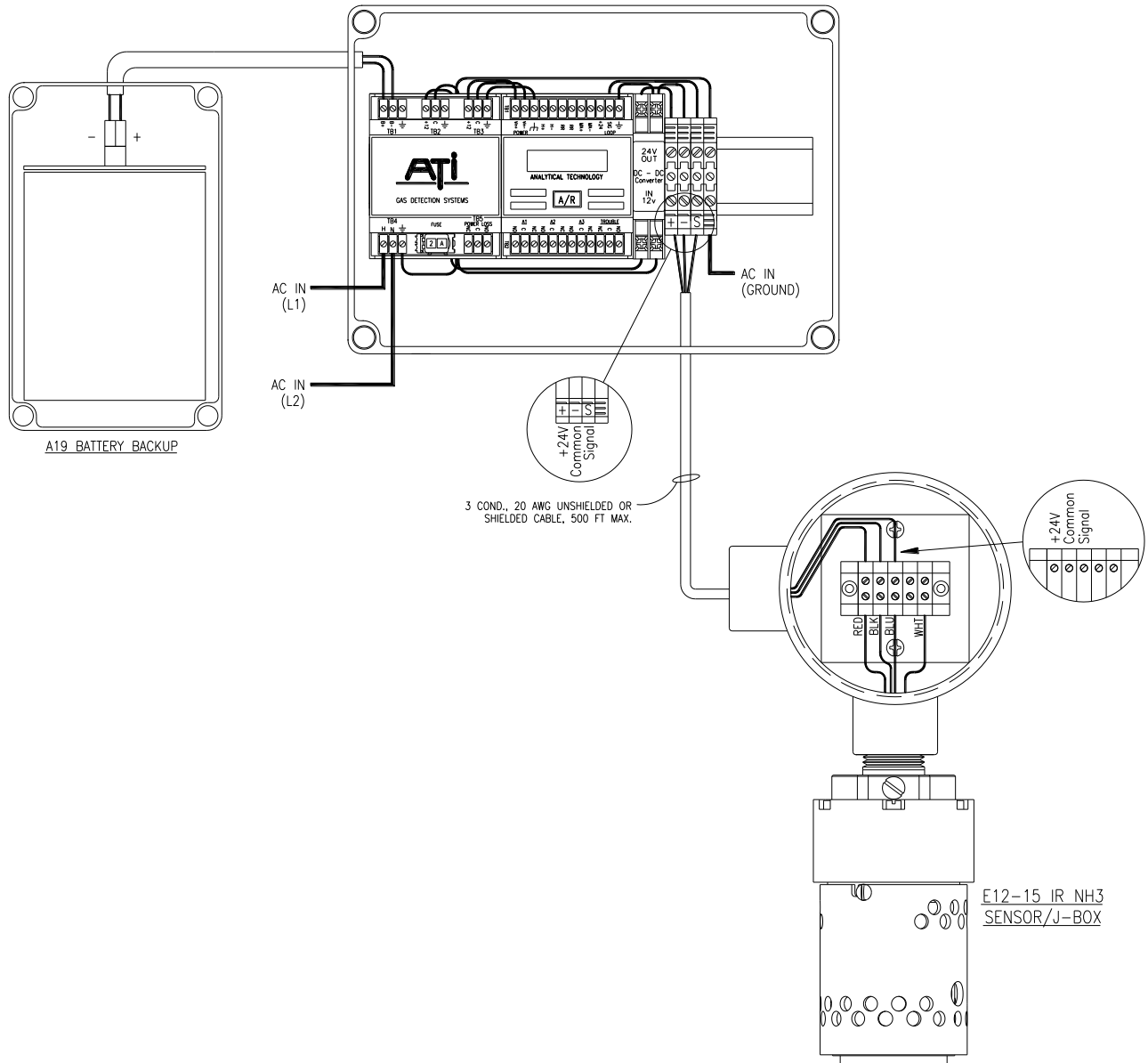

Figure 5 - E12-15 w/12V to 24V Converter and Battery Backup

Warm-up

When power is applied to the transmitter, it enters a one (1) minute warm-up mode. The output current will be 0.8 mA during the warm up time period. At the end of the warm-up period with no faults present, the transmitter automatically enters the normal operating mode (4 mA). If a fault is present after warm-up, the transmitter current output will indicate a fault. See the following chart for fault code status.

Normal Operation

In the normal operating mode, the 4 to 20 mA signal levels correspond to the detected gas concentration. The transmitter continuously checks for system faults or initiation of calibration and automatically changes to the appropriate mode.

The 4 to 20 mA output of the E12-15 is a non-isolated current source.

Current Output and Corresponding Status

<u>Current Output</u>	<u>Status.</u>
0-20 mA	Normal measuring mode
0.6 mA	Unit Fault
0.2 mA	Reference channel fault
0.8 mA	Unit warm up
1.0 mA	Optics fault
1.2 mA	Zero drift fault
1.6 mA	Calibration fault
2.6 mA	Analytical channel fault
2.0 mA	Unit spanning
2.2 mA	Unit zeroing
4.0 mA	Zero gas level (0% LEL)
20 mA	Full scale (100% LEL)
20.1- 23 mA	Over-range (> 100% LEL)



Calibration

The E12-15 is factory calibrated for zero and span. *Unlike catalytic sensors it does not require routine span gas calibration to ensure proper operation.*

The unit must be spanned with cal gas only one time with the target gas. Typically this is done at the factory, but it is possible to field span the device by connecting the unit to a computer and using a software package provided by ATI. Please contact the factory for further details.

A typical field calibration only requires the use of zero air (or 99.99% nitrogen). *If the sensor is located in an area that is known to be free of ammonia then ambient air can be used as a zero reference.* If zero air is used for the calibration, there is a fitting on the bottom of the sensor for a 1/8" ID tubing connection.

Before beginning calibration, use the Insulation Tube to cover outer cylinder holes and connect a clean air source to the sensor's calibration port for a minimum of 3 minutes. To enter into the calibration mode, the calibration wire must be connected to common of the power supply (touch the white wire to the black wire) for ten (10) seconds. Upon release, the sensor will automatically enter the zero calibration routine. The electronics will automatically adjust the sensor's signal to the new zero reference level. During the zero calibration routine, the current output of the E12-15 will go to 2.2 mA. Although this can be accomplished manually, installation of a switch (contact closure) can accomplish the zeroing procedure. It is recommended that this switch be a momentary type switch to prevent it from inadvertently being left in the calibrate position. If after 20 seconds the calibration lead has not been removed from common, the transmitter will ignore the signal and continue operation as normal.

MAINTENANCE

The E12-15 transmitter is continuously monitoring for gas concentrations and faults. If an optical fault is indicated, first try to calibrate the device. If calibration does not correct the fault condition, try to clean the device. The outer barrel (tube with two sets of holes) can be removed (unscrewed) to inspect the cleanliness of the hydrophobic filter. The hydrophobic filter is a Teflon coated stainless steel mesh that keeps moisture out of the optical path. A setscrew holds the filter to the housing. Once the hydrophobic filter is removed, the internal waveguide tube should be inspected for cleanliness. The waveguide and waveguide collar can be removed by inserting rigid tools such as Allen wrenches into one hole of the waveguide and one hole of the collar. Turning the two tools in opposite directions will loosen the waveguide, allowing the collar to be screwed down on to the waveguide until it can be removed from the housing. This will allow the windows of the sensor to be cleaned.

Isopropyl alcohol and cotton tipped swab will provide the best results to clean the windows. Wipe any residue or film left by the alcohol on the windows with a clean dry cotton swab. The internal electro polished wave-guide tube can be cleaned the same way. Be careful not to leave any particles of the cleaning swab in the waveguide. The waveguide holes can collect pieces of the cleaning swab. After reassembling the unit (the waveguide and collar should be very tight to both ends of the housing after installation. Once the unit is completely reassembled and power is reapplied, the transmitter must be calibrated. Refer to the calibration section of this manual.



SPARE PARTS LIST

<u>Part Number</u>	<u>Description</u>
60-0059	Complete IR LEL Gas Transmitter
03-0182	Junction Box Assembly
	Replacement Hydrophobic Filter
	PC IR Link Kit

PRODUCT WARRANTY

Analytical Technology, Inc. (Manufacturer) warrants to the Customer that if any part(s) of the Manufacturer's products proves to be defective in materials or workmanship within the earlier of 18 months of the date of shipment or 12 months of the date of start-up, such defective parts will be repaired or replaced free of charge. Inspection and repairs to products thought to be defective within the warranty period will be completed at the Manufacturer's facilities in Collegeville, PA. Products on which warranty repairs are required shall be shipped freight prepaid to the Manufacturer. The product(s) will be returned freight prepaid and allowed if it is determined by the manufacturer that the part(s) failed due to defective materials or workmanship.

This warranty does not cover consumable items, batteries, or wear items subject to periodic replacement including lamps and fuses.

Gas sensors, except oxygen sensors, are covered by this warranty, but are subject to inspection for evidence of extended exposure to excessive gas concentrations. Should inspection indicate that sensors have been expended rather than failed prematurely, the warranty shall not apply.

The Manufacturer assumes no liability for consequential damages of any kind, and the buyer by acceptance of this equipment will assume all liability for the consequences of its use or misuse by the Customer, his employees, or others. A defect within the meaning of this warranty is any part of any piece of a Manufacturer's product which shall, when such part is capable of being renewed, repaired, or replaced, operate to condemn such piece of equipment.

This warranty is in lieu of all other warranties (including without limiting the generality of the foregoing warranties of merchantability and fitness for a particular purpose), guarantees, obligations or liabilities expressed or implied by the Manufacturer or its representatives and by statute or rule of law.

This warranty is void if the Manufacturer's product(s) has been subject to misuse or abuse, or has not been operated or stored in accordance with instructions or if the serial number has been removed.

Analytical Technology, Inc. makes no other warranty expressed or implied except as stated above.

WATER QUALITY MONITORS

Dissolved Oxygen
Free Chlorine
Combined Chlorine
Total Chlorine
Residual Chlorine Dioxide
Potassium Permanganate
Dissolved Ozone
pH/ORP
Conductivity
Hydrogen Peroxide
Peracetic Acid
Dissolved Sulfide
Residual Sulfite
Fluoride
Dissolved Ammonia
Turbidity
Suspended Solids
Sludge Blanket Level
MetriNet Distribution Monitor

GAS DETECTION PRODUCTS

NH ₃	Ammonia
CO	Carbon Monoxide
H ₂	Hydrogen
NO	Nitric Oxide
O ₂	Oxygen
CO	Cl ₂ Phosgene
Br ₂	Bromine
Cl ₂	Chlorine
ClO ₂	Chlorine Dioxide
F ₂	Fluorine
I ₂	Iodine
H _x	Acid Gases
C ₂ H ₄ O	Ethylene Oxide
C ₂ H ₆ O	Alcohol
O ₃	Ozone
CH ₄	Methane (Combustible Gas)
H ₂ O ₂	Hydrogen Peroxide
HCl	Hydrogen Chloride
HCN	Hydrogen Cyanide
HF	Hydrogen Fluoride
H ₂ S	Hydrogen Sulfide
NO ₂	Nitrogen Dioxide
NO _x	Oxides of Nitrogen
SO ₂	Sulfur Dioxide
H ₂ Se	Hydrogen Selenide
B ₂ H ₆	Diborane
GeH ₄	Germane
AsH ₃	Arsine
PH ₃	Phosphine
SiH ₄	Silane
HCHO	Formaldehyde
C ₂ H ₄ O ₃	Peracetic Acid
DMA	Dimethylamine