



O & M Manual



B14 Monitor System

Home Office

Analytical Technology, Inc.
6 Iron Bridge Drive
Collegeville, PA 19426
Phone: 800-959-0299
610-917-0991
Fax: 610-917-0992
Email: sales@analyticaltechnology.com
Web: www.Analyticaltechnology.com

European Office

ATI (UK) Limited
Unit 1 & 2 Gatehead Business Park
Delph New Road, Delph
Saddleworth OL3 5DE
Phone: +44 (0)1457-873-318
Fax: + 44 (0)1457-874-468
Email: sales@atiuk.com

TABLE OF CONTENTS

INTRODUCTION	4
B12 SENSOR/TRANSMITTER	5
B14 RECEIVER MODULE.....	5
A17 POWER SUPPLY MODULE.....	5
NEMA 4X ENCLOSURE.....	5
EXPLOSION-PROOF ENCLOSURES	5
AUDIBLE HORN	6
STROBE LAMP	6
A19 BATTERY BACK-UP.....	6
MECHANICAL INSTALLATION.....	7
ELECTRICAL INSTALLATION	12
B14 RECEIVER MODULE.....	24
ELECTRICAL CONNECTION	24
FACTORY CONFIGURATION	26
CONFIGURATION SWITCHES	27
OPERATING RANGE CHART	28
SETPOINT SELECTION	29
RANGE SELECTION	30
RELAY CONFIGURATION.....	30
EXTERNAL HORN RELAY.....	31
OPERATION	32
ALARM ACKNOWLEDGE AND RESET	32
TROUBLE ALARM AND RELAY.....	33
LAMP AND HORN TEST.....	33
INHIBIT MODE	33
REMOTE RESET.....	34
ANALOG OUTPUT	34
TROUBLESHOOTING.....	34
RECEIVER MODULE PARTS LIST.....	35
UNIVERSAL POWER SUPPLY	36
CAUTION	36
POWER SUPPLY PARTS LIST	38
BATTERY BACK-UP UNIT.....	39
INSTALLATION.....	39
OPERATION.....	40
REMOVAL FROM SERVICE.....	40
BATTERY BACK-UP PARTS LIST	41
STROBE LIGHT.....	42
STROBE PARTS LIST.....	43

TABLE OF FIGURES

Figure 1 - Single Module System Enclosure Dimensions (80-0005).....	8
Figure 2 - Two Module System Enclosure Dimensions (80-0006).....	9
Figure 3 - Three Module System Enclosure Dimensions (80-0007)	10
Figure 4 - Six Module System Enclosure Dimensions (80-0008).....	11
Figure 5 - Single Point Receiver Internal Wiring (ATI-0172)	12
Figure 6 - Dual Point Receiver Internal Wiring (ATI-0173).....	13
Figure 7 - Four Point Receiver Internal Wiring (ATI-0174).....	14
Figure 8 - Receiver Connection to 65W Power Supply (ATI-0545).....	15
Figure 9 - Typical System Wiring, Nemz-4 Transmitter Version (ATI-0175)	16
Figure 10 - Typical System Wiring, Explosion-Proof B12 Sensor/Transmitter (ATI-0176)	17
Figure 11 - Typical System Wiring, B12-17 Combustible Sensor/Transmitter (ATI-0215).....	18
Figure 12 - Typical System Wiring, C12-17 Combustible Sensor/Transmitter (ATI-0609)	19
Figure 13 - Typical System Wiring, A12 2-Wire Transmitter (ATI-0179).....	20
Figure 14 - Typical System Wiring, A12-17 Combustible Transmitter (ATI-0355)	21
Figure 15 - Typical System Wiring, D12 Transmitter (2-Wire Hookup) (ATI-0610).....	22
Figure 16 - Typical System Wiring, D12 Transmitter (3-Wire Hookup) (ATI-0611).....	23
Figure 17 - Front Panel Controls & LEDs (ATI-0177).....	24
Figure 18 - Receiver Module Terminals (ATI-0178)	25
Figure 19 - Configuration Board Switch Location.....	28
Figure 20 - Power Supply Terminal Connections (ATI-030).....	37
Figure 21 - Battery Back-up Mounting Dimensions.....	39
Figure 22 - External Strobe Light Connections (ATI-0202)	42

INTRODUCTION

The B14 is an on-line monitoring system for the detection of hazardous gases in ambient air. It is designed to detect and alarm gas leaks from storage cylinders, process piping, or gas feed equipment in virtually any type of industrial plant environment. Systems are available for monitoring a variety of gases as shown in Table 1-1.

TABLE 1-1

GAS	CODE NO.	STD. RANGE	MIN. RANGE	MAX. RANGE
GENERAL GASES				
Ammonia	15	0-100 PPM	0-50 PPM	0-500 PPM
Carbon Monoxide	16	0-100 PPM	0-50 PPM	0-500 PPM
Hydrogen	18	0-4 %	0-2000 PPM	0-10 %
Nitric Oxide	25	0-100 PPM	0-25 PPM	0-500 PPM
Oxygen	19	0-25%	0-10%	0-100%
Phosgene	20	0-2 PPM	0-1 PPM	0-100 PPM
OXIDANT GASES				
Bromine	10	0-2 PPM	0-1 PPM	0-100 PPM
Chlorine	11	0-10 PPM	0-1 PPM	0-100 PPM
Chlorine Dioxide	12	0-2 PPM	0-1 PPM	0-100 PPM
Fluorine	13	0-2 PPM	0-1 PPM	0-100 PPM
Hydrogen Peroxide	34	0-10 PPM	0-10 PPM	0-100 PPM
Ozone	14	0-2 PPM	0-1 PPM	0-100 PPM
Iodine	35	0-2 PPM	0-1 PPM	0-100 PPM
ACID GASES				
Hydrogen Chloride	21	0-20 PPM	0-10 PPM	0-200 PPM
Hydrogen Cyanide	22	0-20 PPM	0-10 PPM	0-200 PPM
Hydrogen Fluoride	23	0-20 PPM	0-10 PPM	0-200 PPM
Hydrogen Sulfide	24	0-50 PPM	0-10 PPM	0-500 PPM
Nitrogen Dioxide	26	0-20 PPM	0-5 PPM	0-200 PPM
Sulfur Dioxide	27	0-20 PPM	0-10 PPM	0-200 PPM
HYDRIDE GASES				
Arsine	28	0-1000 PPB	0-1000 PPB	0-100 PPM
Diborane	29	0-1000 PPB	0-1000 PPB	0-100 PPM
Germane	30	0-1000 PPB	0-1000 PPB	0-100 PPM
Hydrogen Selenide	31	0-1000 PPB	0-1000 PPB	0-100 PPM
Phosphine	32	0-1000 PPB	0-1000 PPB	0-100 PPM
Silane	33	0-10 PPM	0-1000 PPB	0-100 PPM

The B14 system consists of modular components that can be used in a variety of configurations to fit specific application requirements. A description of the major system components follows:

B12 Sensor/Transmitter

Consists of an electrochemical gas sensor closely coupled to a NEMA 4X transmitter. This component measures gas concentration and converts the measurement to 4-20 mA current for transmission to a receiver module. It must be mounted in the area where gas leakage or buildup is expected, and can either be wall mounted or supported by electrical conduit carrying interconnecting wiring. For hazardous areas, explosion-proof sensor/transmitters are available.

B14 Receiver Module

Receives current data from the sensor/transmitter and provides an LED display of gas concentration, three gas alarm setpoints, three gas alarm relays, an isolated 4-20 mA output, and a trouble alarm and relay. The receiver is packaged in a compact DIN rail mount housing, and fits easily into NEMA 4X enclosures suitable for one, two, three, or six modules. Each module is switch programmable for full scale range, alarm setpoints, relay latch/non-latch operation, and relay normal/fail-safe operation. A single switch (marked A/R) on the front panel provides alarm acknowledge and reset functions, and can also be used to test front panel LED indicators and to inhibit alarm relays. LED bars on the front panel provide visual indication of alarm status.

A17 Power Supply Module

Provides 12 VDC power to one or two receiver modules plus power for an audible horn and for charging an external battery. Packaged in the same compact DIN rail mount module used for the receiver, the power supply is designed for use throughout the world. Input to this module may be any AC (50 or 60 Hz.) or DC voltage between 85 and 270 volts. The supply is self-regulating, meaning no jumper changes, no changes in switch settings, and no variation in wiring pattern. A power failure alarm relay is included in the module to signal the loss of input power.

NEMA 4X Enclosure

Four standard enclosures are available for housing receiver and power supply modules. Polystyrene enclosures are suitable for outdoor environments, and digital displays and alarm indicators are clearly visible through a clear polycarbonate window on the front. The window hinges open to gain access to the receiver A/R control switch, and the entire front section of the enclosure can be removed for ease of mounting and wiring. Enclosures are provided with knockouts on all four sides to facilitate wiring, and ½" FNPT conduit hubs are provided with each enclosure.

Explosion-proof Enclosures

Two versions are available to allow use of the receiver and power supply modules in hazardous areas. One version is suitable for a single receiver module, while the second is large enough to contain both a power supply and a receiver. Enclosures are rated for Class 1, Division 1, Groups C & D. Group B enclosures are also available if required. All explosion-proof enclosures can be supplied with an external acknowledge and reset switch.

Audible Horn

A 12 VDC piezoelectric alarm horn is available for mounting into any of the NEMA 4X enclosures. The horn is wired to the receiver module and will sound intermittently when the warning setpoint is reached, and continuously when the alarm setpoint is reached. The horn can be silenced by pushing the A/R switch on the receiver front panel. A single horn can be wired through multiple receivers and will sound if any receiver goes into alarm.

Strobe Lamp

Provides a bright visual indication of an alarm condition. The strobe uses a xenon flash lamp to give a high intensity flash approximately 70 times a minute. The strobe is wired to one of the alarm relays, with power for the strobe supplied from the power supply module. Mounting is by ½" MNPT nipple, making it convenient to mount directly to a NEMA enclosure.

A19 Battery Back-up

Provides a 12 VDC, 4 AH battery and charging control circuitry in a separate NEMA 4X enclosure. The battery backup connects directly to the A17 power supply module to provide standby power to the detection system. If AC power is lost, the battery insures that detection continues uninterrupted.

B14 components allow simple assembly of either single or multipoint detection systems. Each point of detection requires one sensor/transmitter and one receiver. The sensor/transmitter is mounted in the hazard area, and the receiver is located anywhere within 1000 feet. If the user has a regulated 12-28 VDC power supply and an enclosure to house the receiver, nothing else is required. If not, one power supply for every two receivers is needed for power, and an enclosure of a size to contain the modules is needed for environmental protection. An optional horn and strobe may be added if desired.

MECHANICAL INSTALLATION

System enclosures, battery back-up units, and sensor transmitters are all designed for surface mounting using screws or bolts inserted through the recessed mounting holes at each corner of the enclosures. Included with each system enclosure is a template with mounting hole dimensions for two and three module system enclosures, battery back-up enclosure, and sensor/transmitter enclosure. The template can be used to mark hole centers on walls or mounting panels.

Mounting recesses are suitable for #6 or #8 machine screws or wood screws. Screw length will vary with specific site conditions.

Two and three module system enclosures provide knockouts on all four sides to allow wiring conduit to be connected in the most convenient way. Enclosures are shipped with all knockouts in place except for the larger knockout on the bottom, where the audible horn is installed if ordered. See Pages 1-6 through 1-9 for dimensional drawings of the one, two, three and six module enclosures.

Each enclosure is supplied with conduit hubs for connection of ½" NPT threaded conduit. Also included is a seal ring for each hub. **Seal rings are required to provide a water tight conduit hub connection to the enclosure.** The following lists the number of hubs that should be included with each enclosure type.

- Two module Enclosure - 4 hubs
- Three module Enclosure - 6 hubs
- Six Module Enclosures - 6 hubs
- Battery back-up Enclosure - 2 hubs
- Sensor/Transmitter Enclosure - 1 hub

Conduit hubs are installed in any enclosure knockout labeled PG16. Note that some knockouts have more than one designation, such as PG11/16. Those with two designations will have concentric circles for knockouts. The inner circle marks the lower PG number while the outer circle marks the higher number. Place a thin bladed screwdriver into the circular slot or the desired knockout size and tap firmly with a hammer. To install the hub, place the seal ring over the threaded part of the hub. Locate the hub nut on the inside of the enclosure and screw the hub into the hub nut from the outside. Tighten firmly to insure that the seal ring provides a good seal between the hub and the outside of the enclosure.

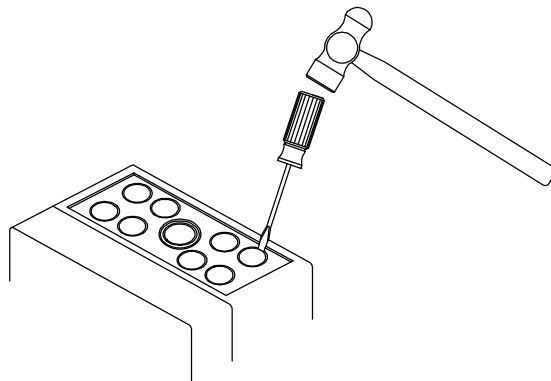

For installations where conduit will not be used, cable gland seal fittings must be installed in the conduit hubs. Plastic cable glands are available from most electrical supply stores. Gland seals with ½" NPT threads will screw directly into the conduit hub. Gland seals are also available from ATI for installation directly into the enclosures in place of the conduit hubs. Refer to the parts list for the correct part number of the cable gland seals.

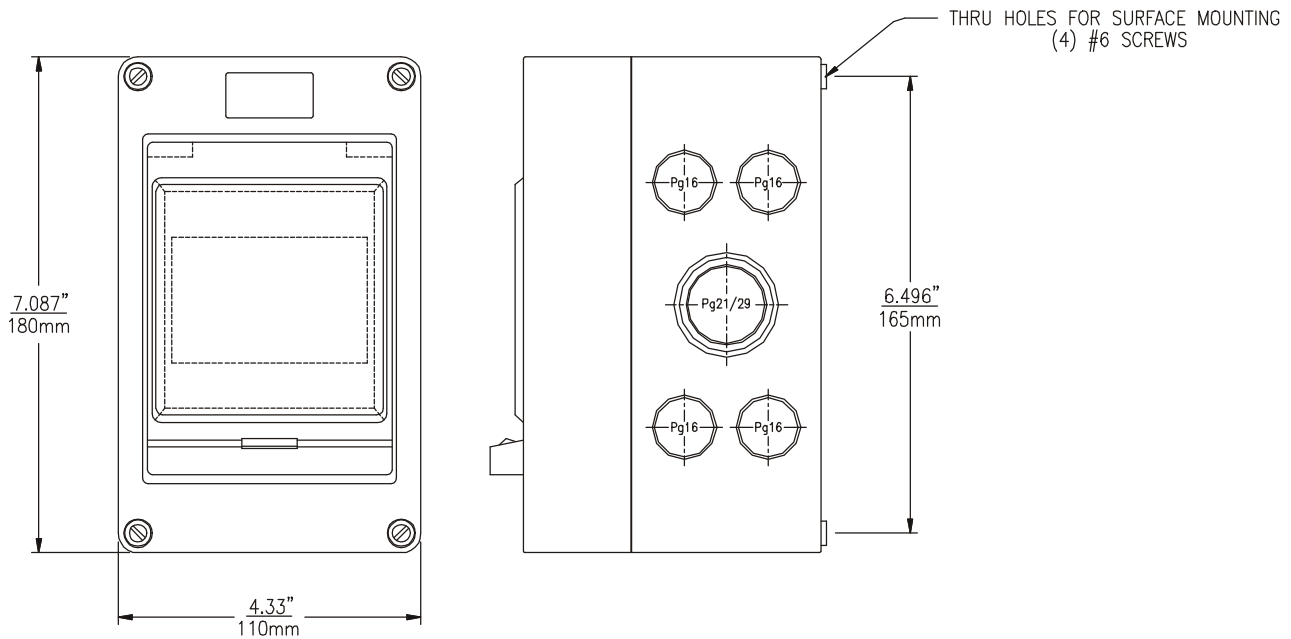

Figure 1 - Single Module System Enclosure Dimensions (80-0005)

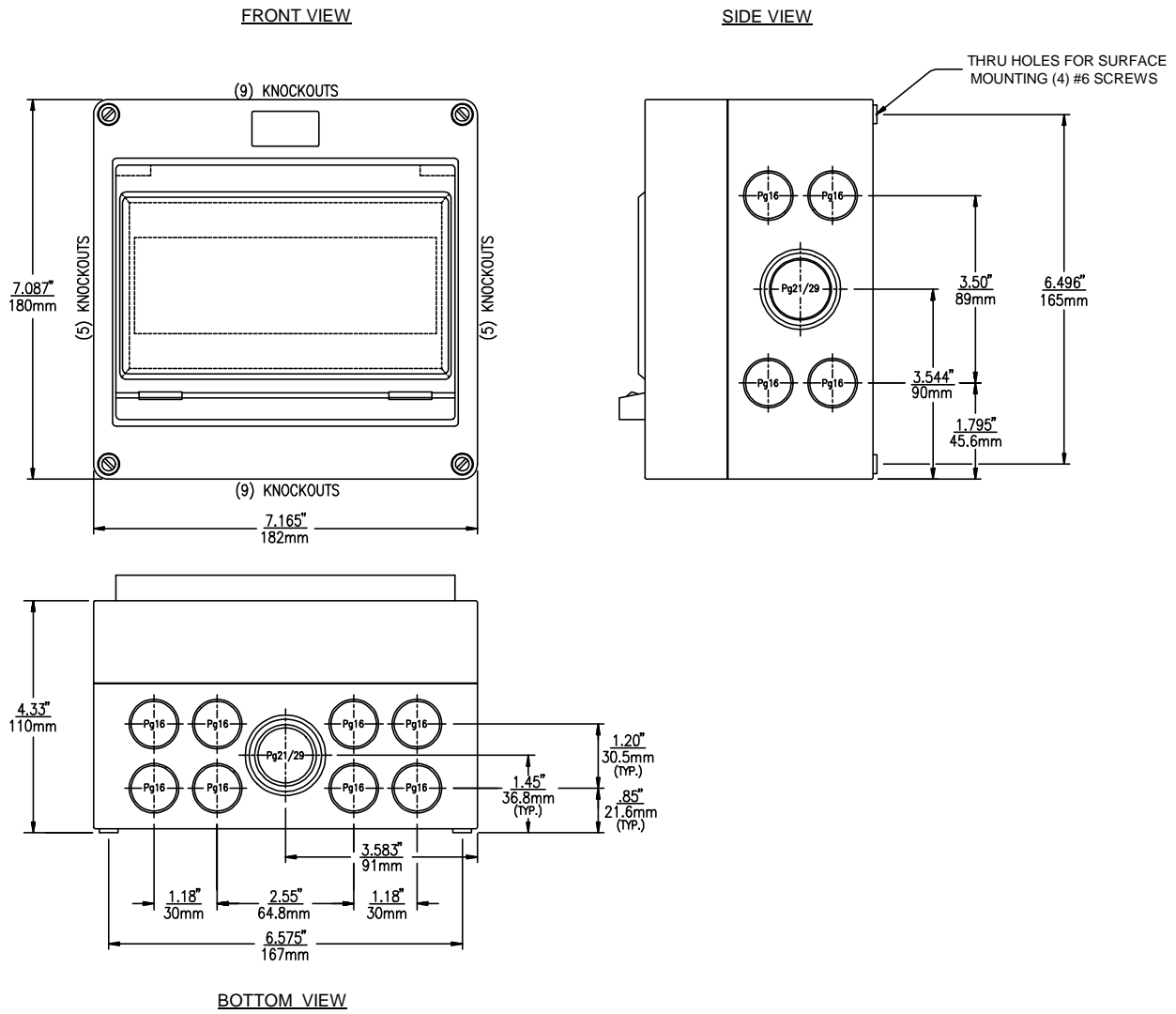

Figure 2 - Two Module System Enclosure Dimensions (80-0006)

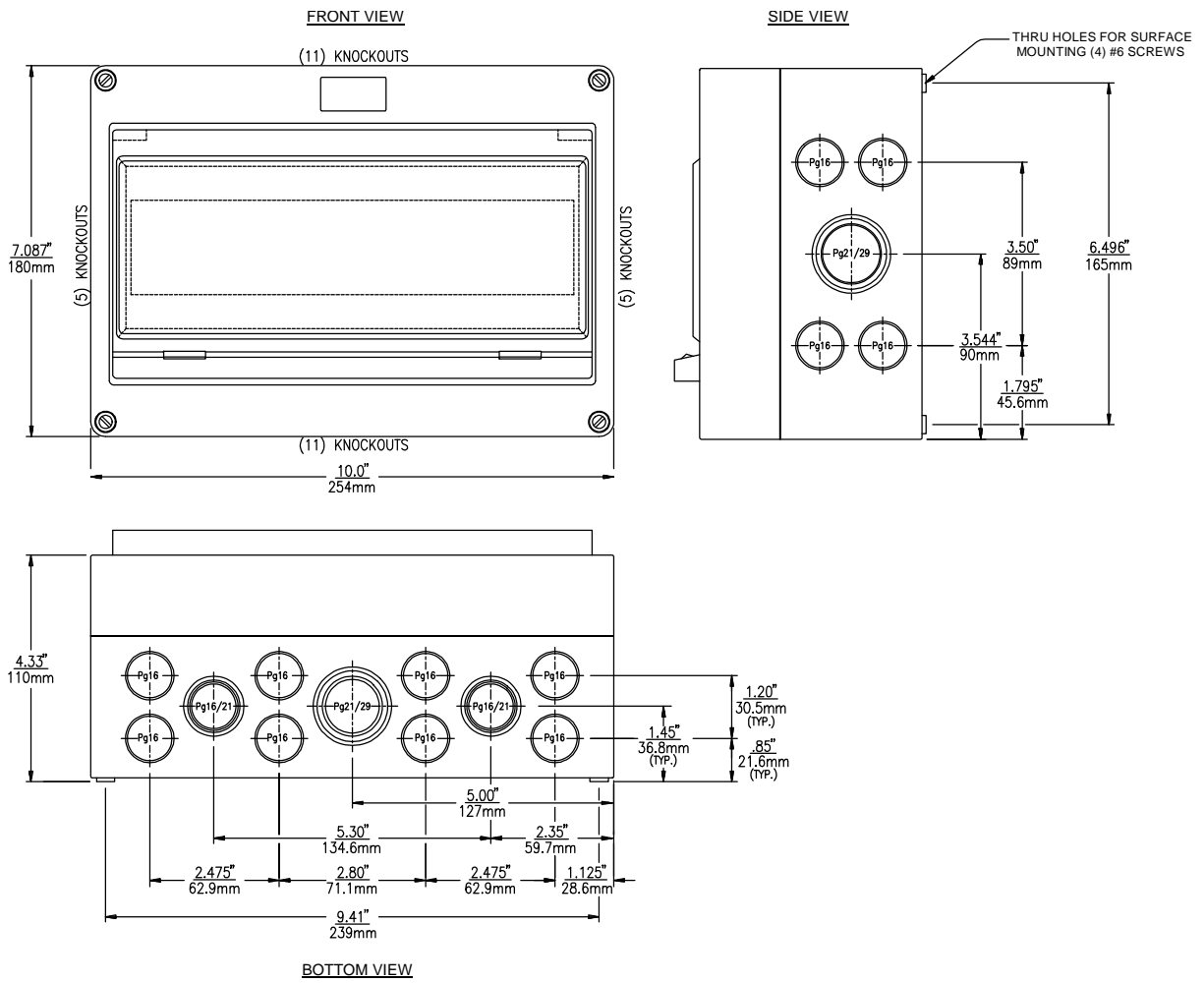

Figure 3 - Three Module System Enclosure Dimensions (80-0007)

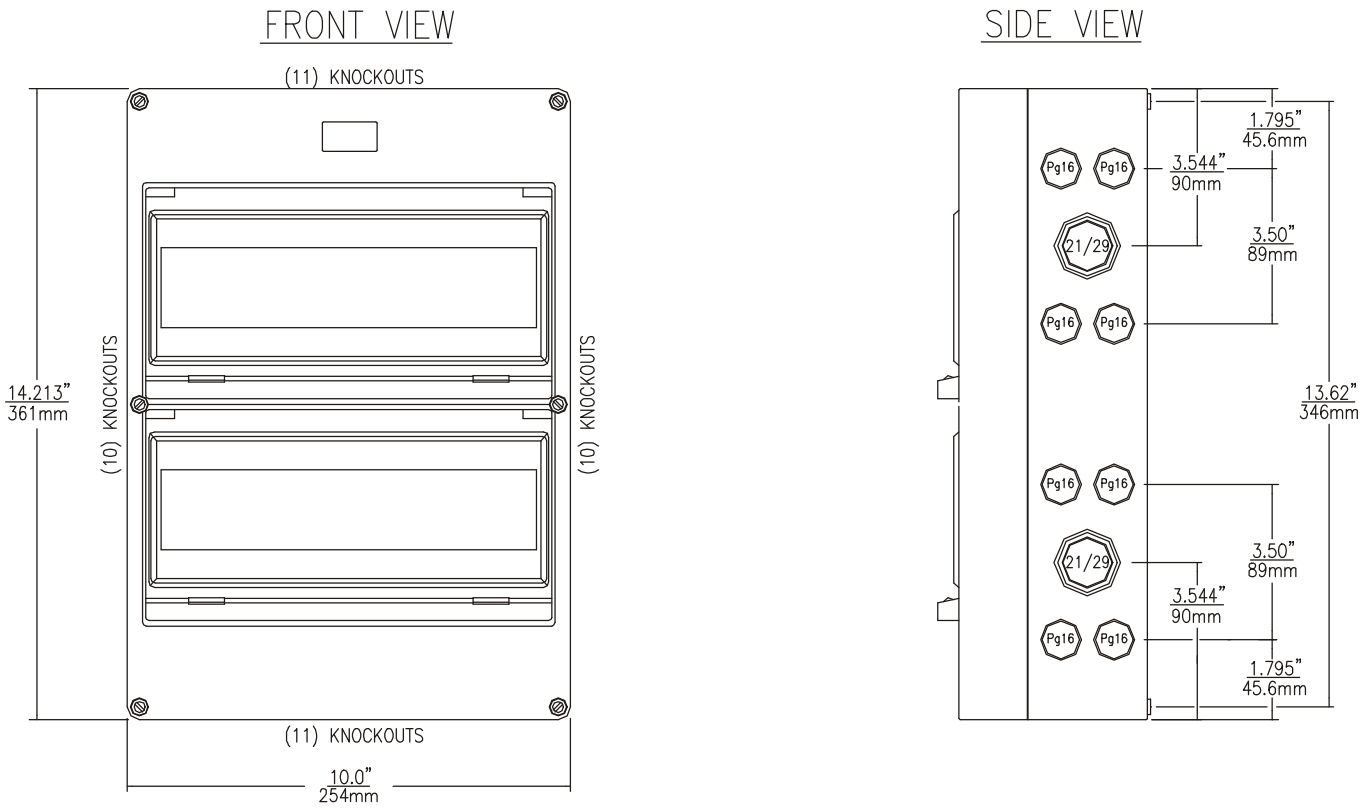

Figure 4 - Six Module System Enclosure Dimensions (80-0008)

ELECTRICAL INSTALLATION

Field wiring required for a detection system includes connection of AC power, connection of two conductor cable between the receiver and the sensor/transmitter, and connection of the battery back-up unit if it was purchased with the system. ATI does not supply an AC power cord with the system. A 25 foot length of 2 conductor interconnect cable is supplied for connection of the sensor/transmitter to the receiver. Longer lengths up to 1000 feet may be used when required.

Single point detection systems are supplied with the power supply, receiver, and optional horn factory wired as shown in Figure 5 below.

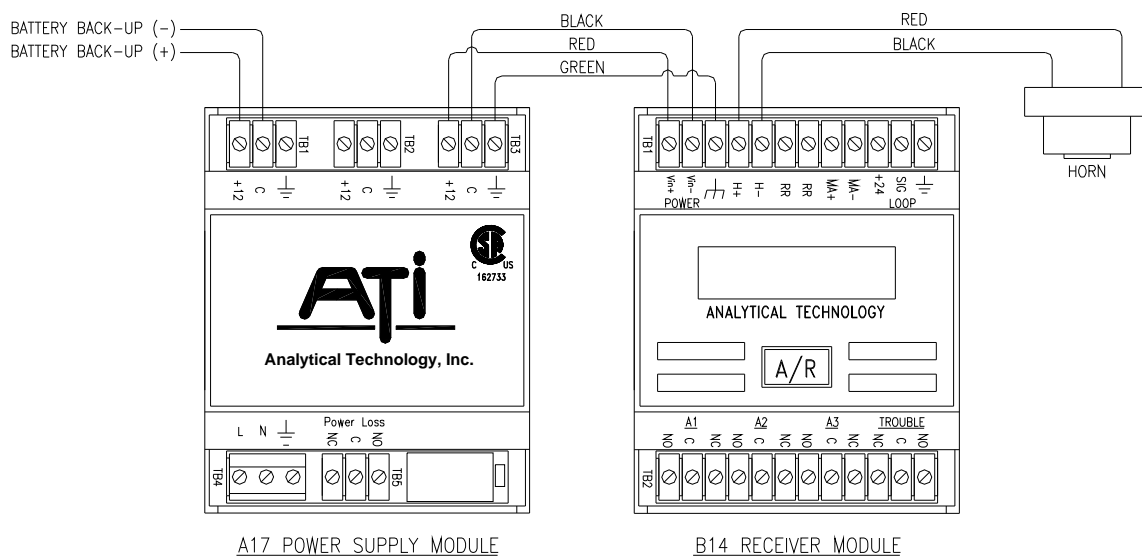

Figure 5 - Single Point Receiver Internal Wiring (ATI-0172)

Figure 18 on page 24 of this manual shows a detailed terminal wiring drawing for the Receiver module. Figure 20 on page 36 shows a detailed terminal wiring drawing for the Power supply module.

A B14 gas detection system will always contain a B14 Receiver and either a B12 Sensor/Transmitter, or an A12 **UniSens** 2-Wire Transmitter. Normally, an A17 Power supply module will also be included, and an A19 Battery Back-up Unit will often be used to provide standby power for the system. Figures 8 and 9 provide interconnecting wiring diagrams for a typical single channel system connected to a B12 Sensor/Transmitter. Figure 13 provides an interconnect wiring diagram for a typical single channel system connected to an A12 2-Wire Transmitter.

Two point detectors include one power supply and two receivers. These systems are shipped factory wired as shown in Figure 1-6 below.

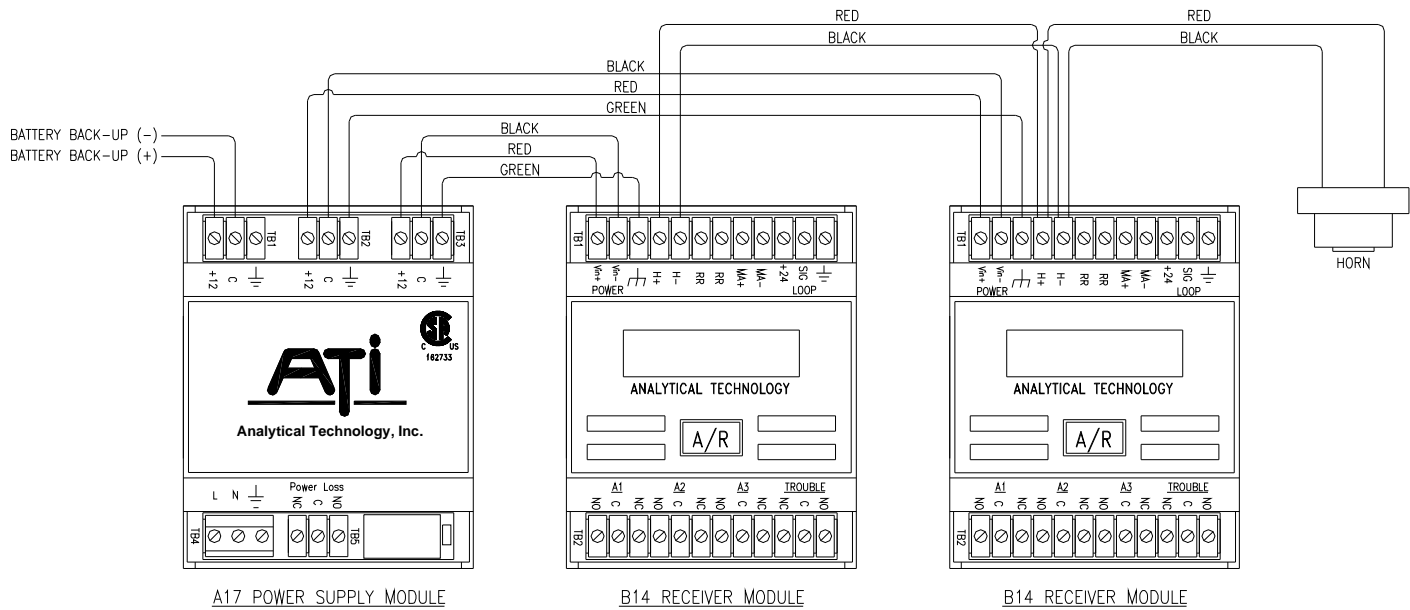

Figure 6 - Dual Point Receiver Internal Wiring (ATI-0173)

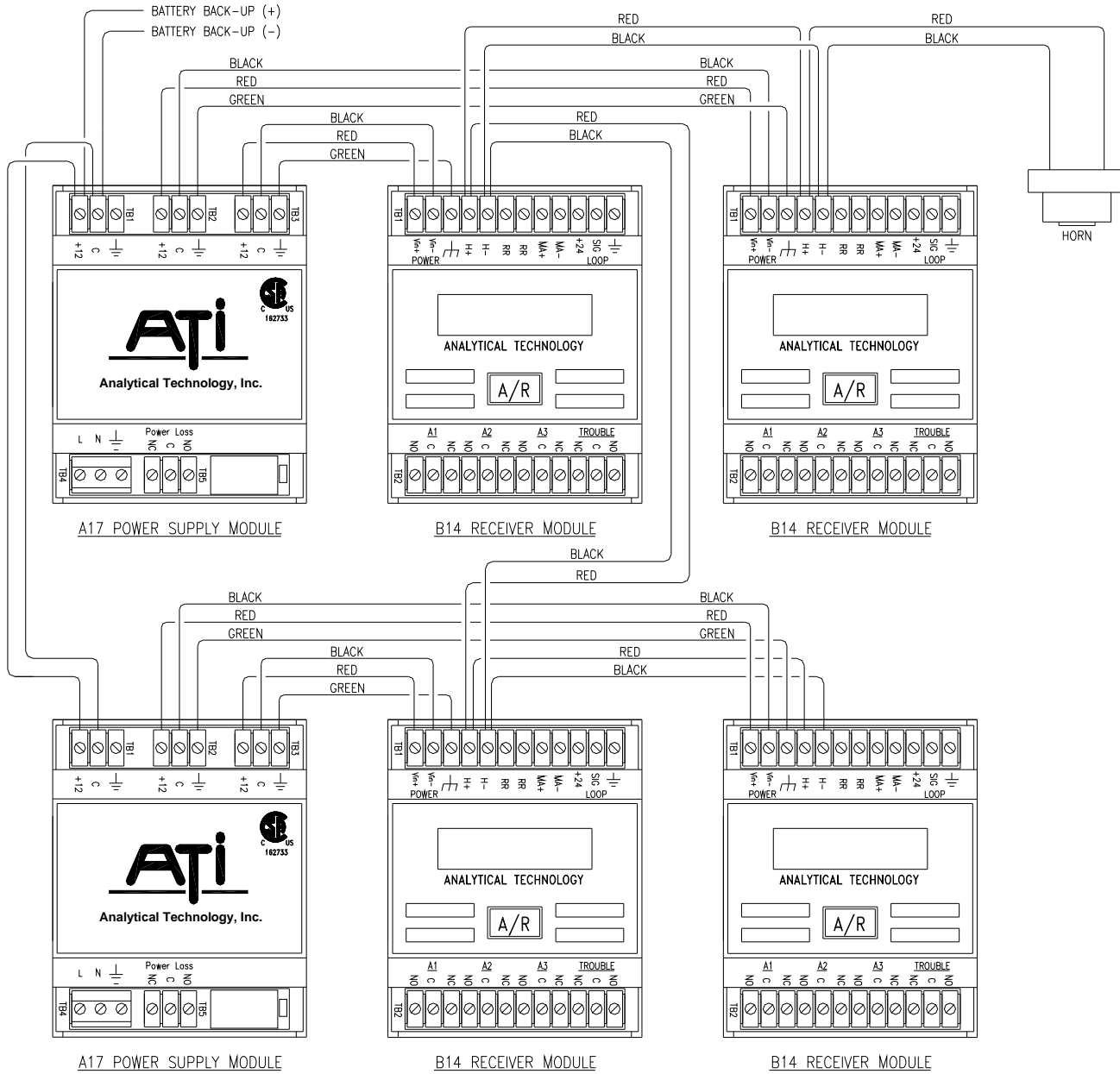

Figure 7 - Four Point Receiver Internal Wiring (ATI-0174)

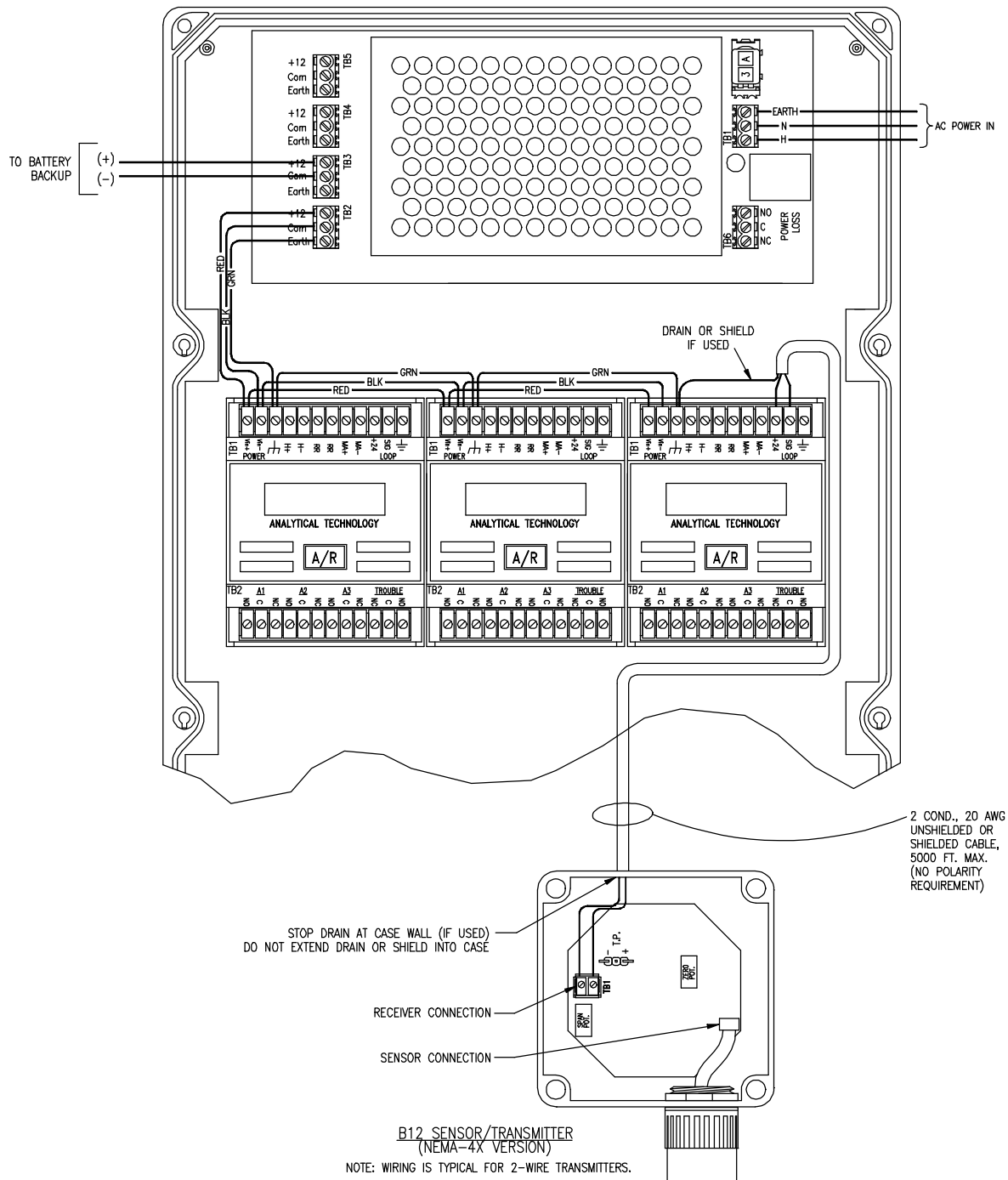

Figure 8 - Receiver Connection to 65W Power Supply (ATI-0545)

Sensor/transmitters contain a terminal block for receiver connection. Connection of the two wires from the receiver is not polarity sensitive. These wires can be connected without regard to terminal position. Multi-channel systems will duplicate the 2 conductor cable wiring between the Receiver and Sensor/Transmitter.

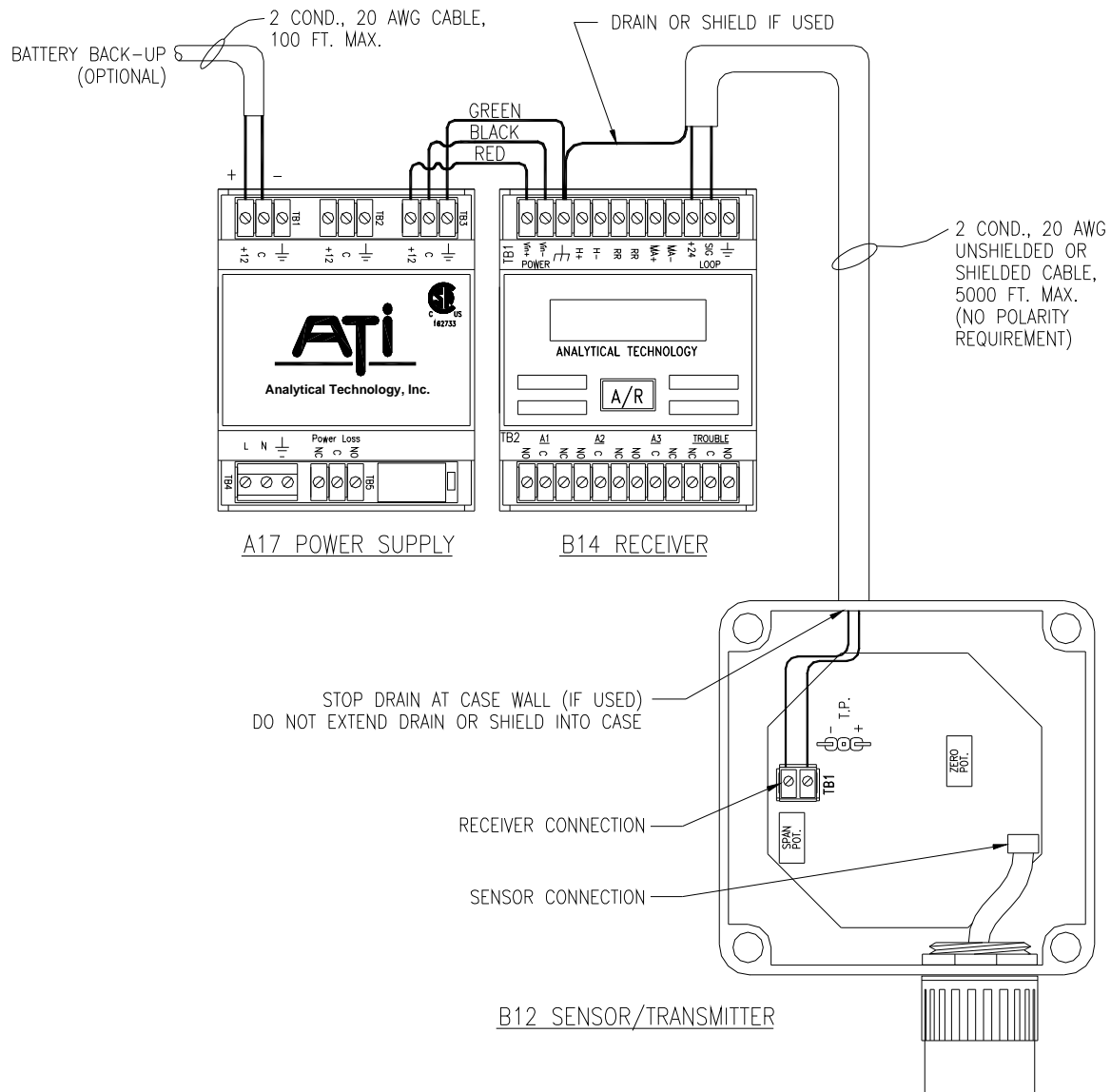

Figure 9 - Typical System Wiring, Nemz-4 Transmitter Version (ATI-0175)

CAUTION: Be very careful when removing the knockouts on the sensor/transmitter enclosure. A small bladed screwdriver tapped firmly in the knockout recess is all that is necessary. Do not drive the screwdriver blade into the transmitter enclosure or it may strike the circuit board and cause component damage.

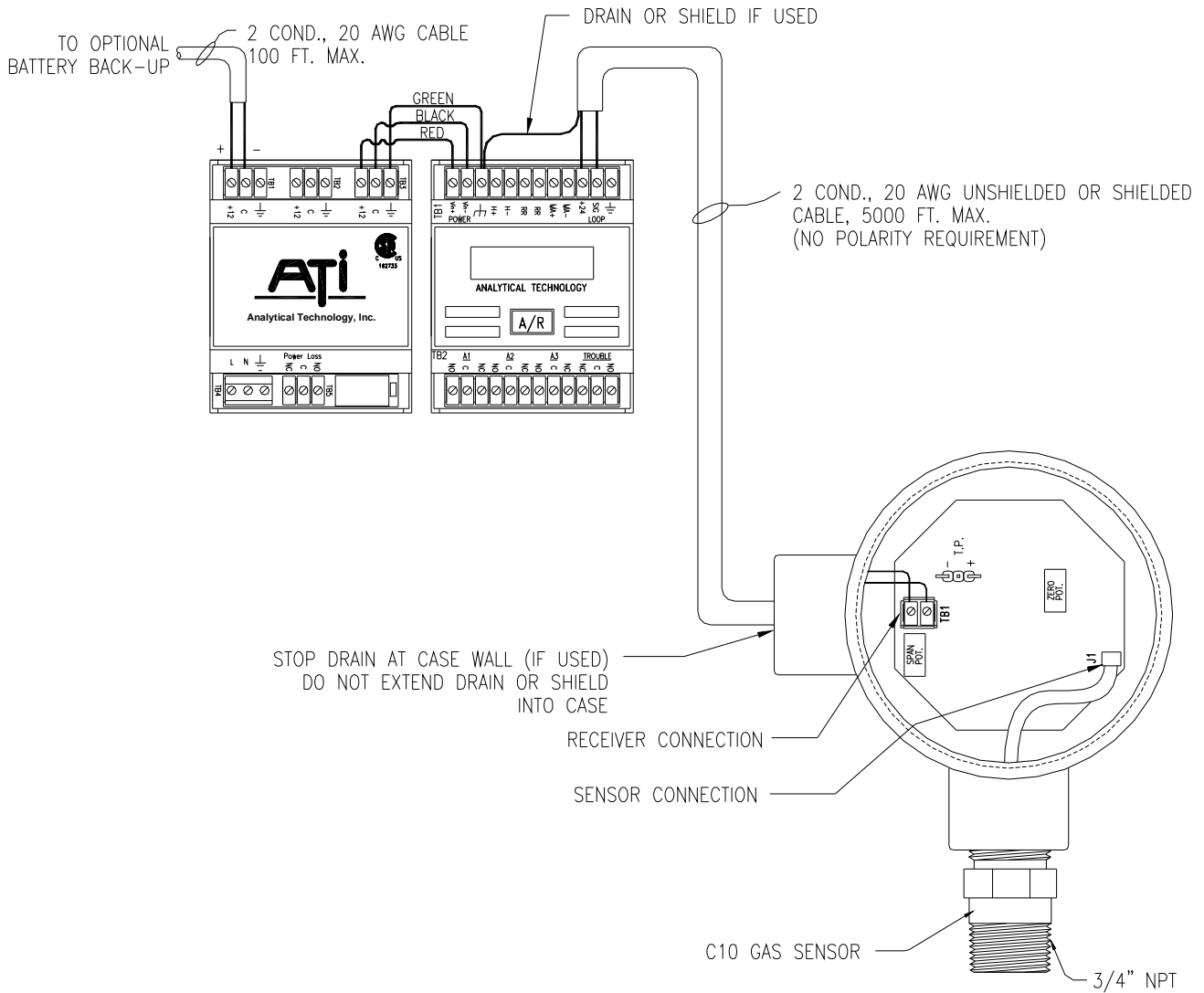

Figure 10 - Typical System Wiring, Explosion-Proof B12 Sensor/Transmitter (ATI-0176)

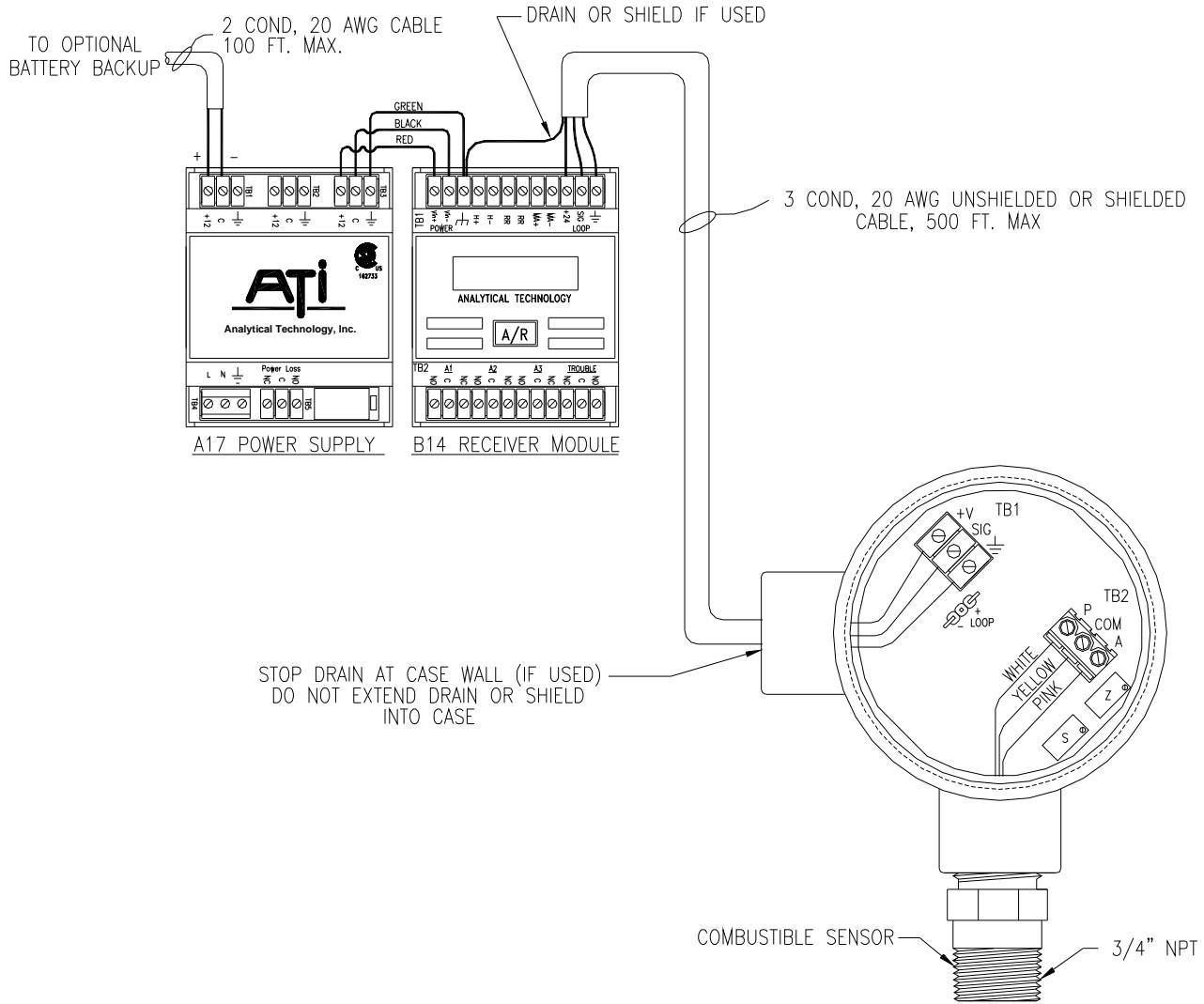

Figure 11 - Typical System Wiring, B12-17 Combustible Sensor/Transmitter (ATI-0215)

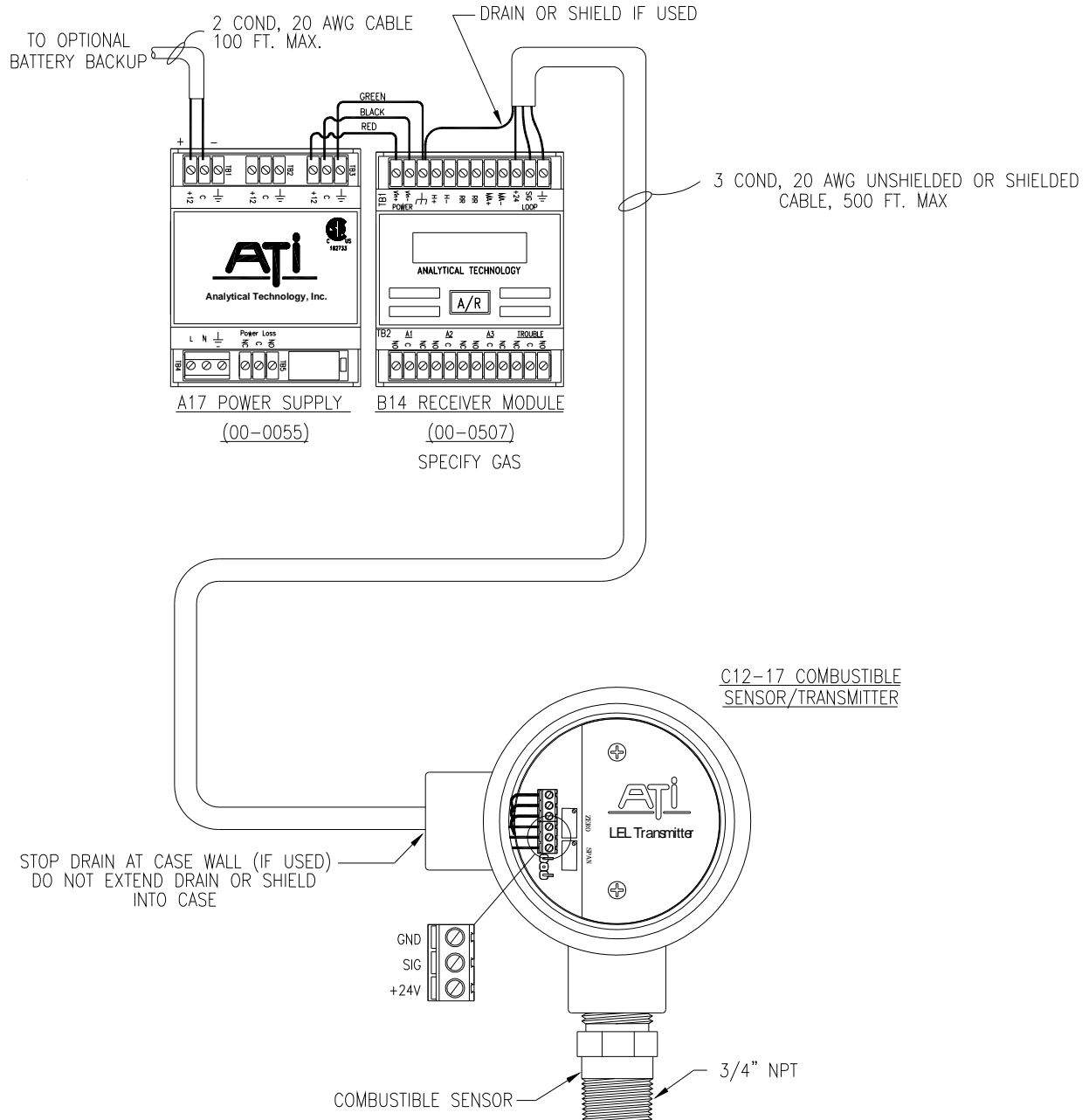

Figure 12 - Typical System Wiring, C12-17 Combustible Sensor/Transmitter (ATI-0609)

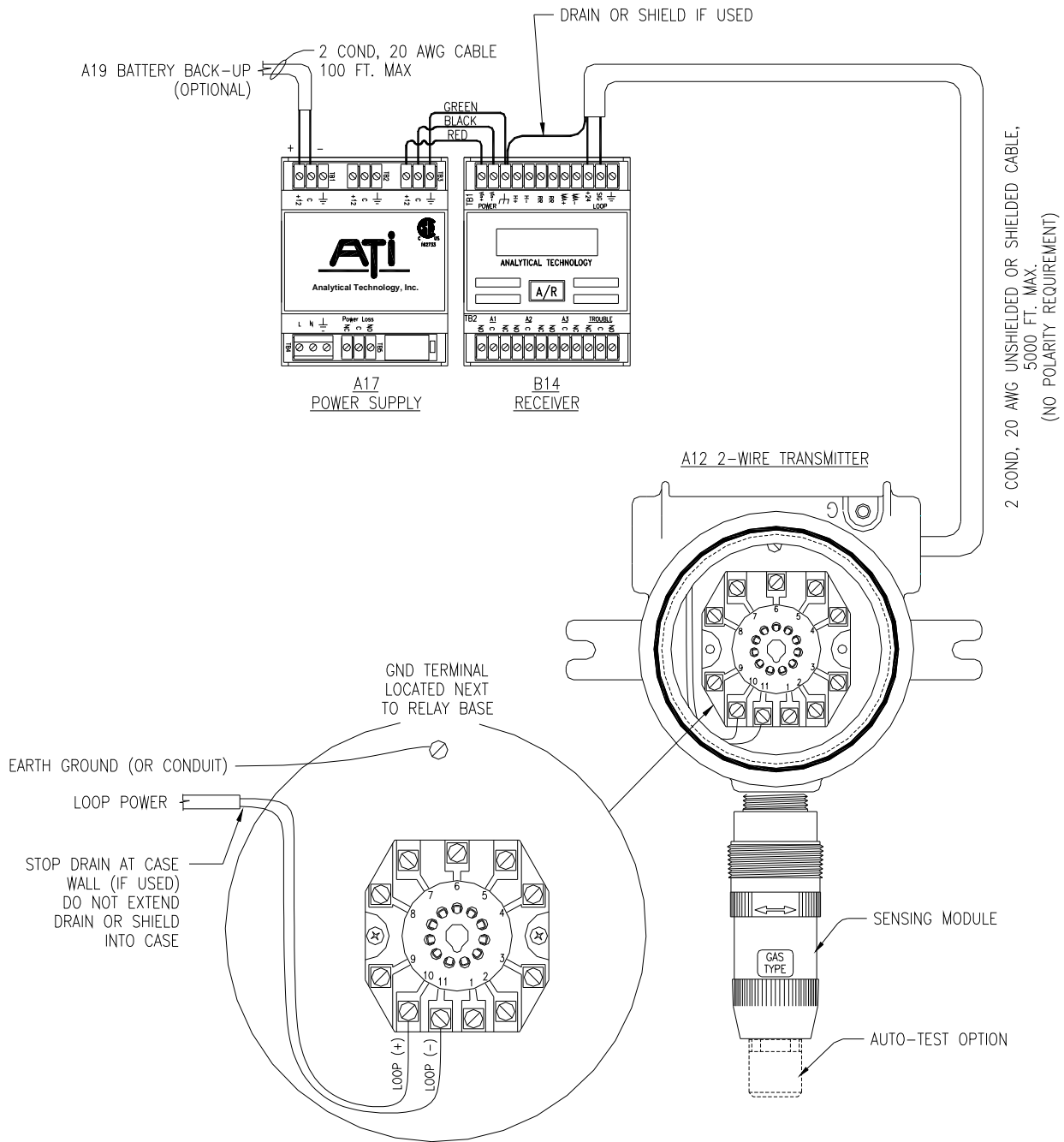

Figure 13 - Typical System Wiring, A12 2-Wire Transmitter (ATI-0179)

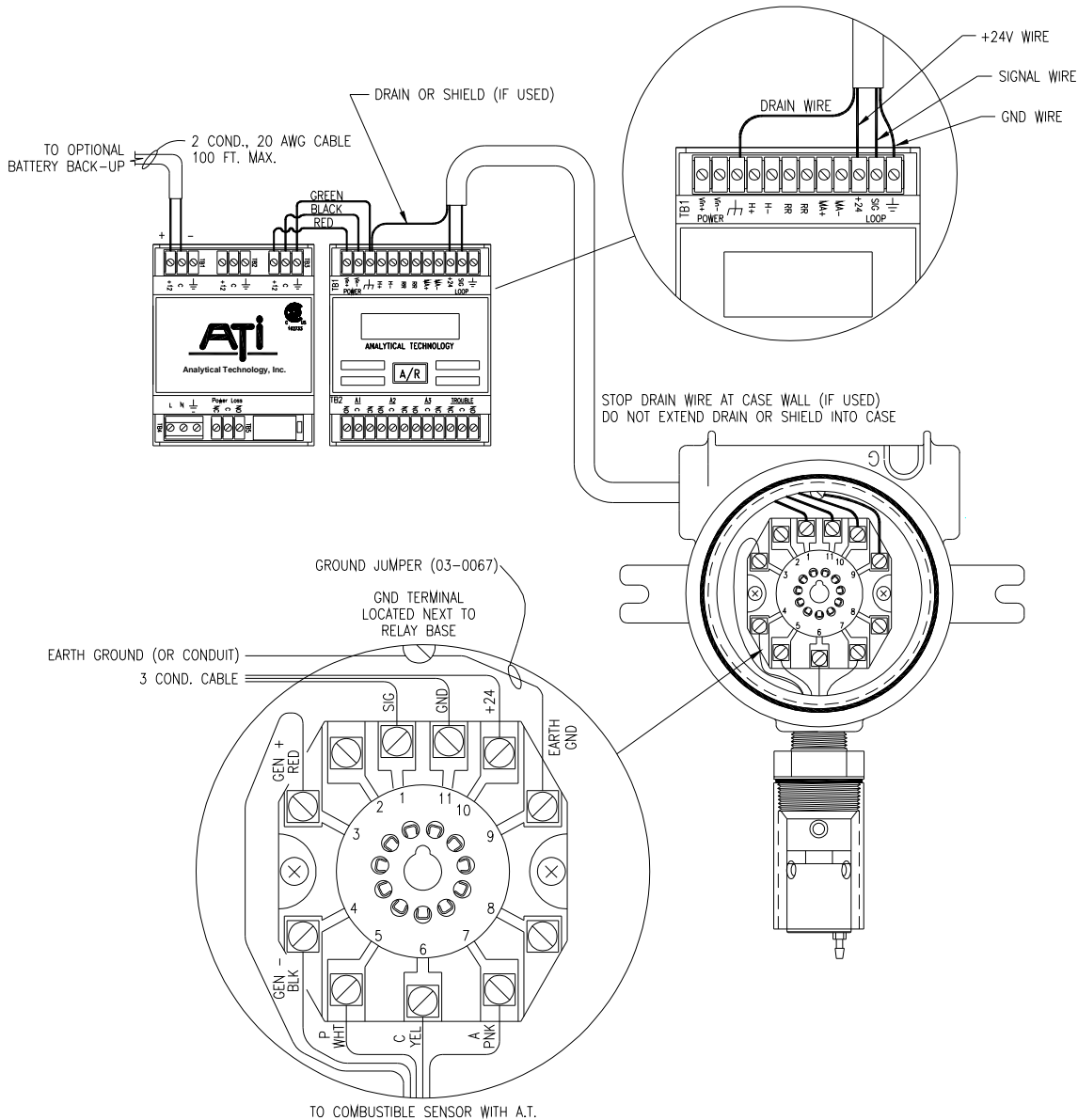

Figure 14 - Typical System Wiring, A12-17 Combustible Transmitter (ATI-0355)

The remainder of this manual is divided into sections that describe each component of the system. Mechanical and electrical installation are the only requirements to provide a workable system. Power supply modules and battery back-up units require no adjustments. Receiver modules are factory set to the range specified on the order, and alarm setpoints will be set to default values unless otherwise specified on the order. Sensor/transmitters are factory calibrated, and should require no adjustments when placed in service. Calibration can be checked if desired according to the instructions in the Sensor/transmitter section of this manual.

Normal operation of the system uses the switch on the Receiver module. The “Operation” portion of the Receiver section (section 2) should be read and understood before placing the detection system into operation.

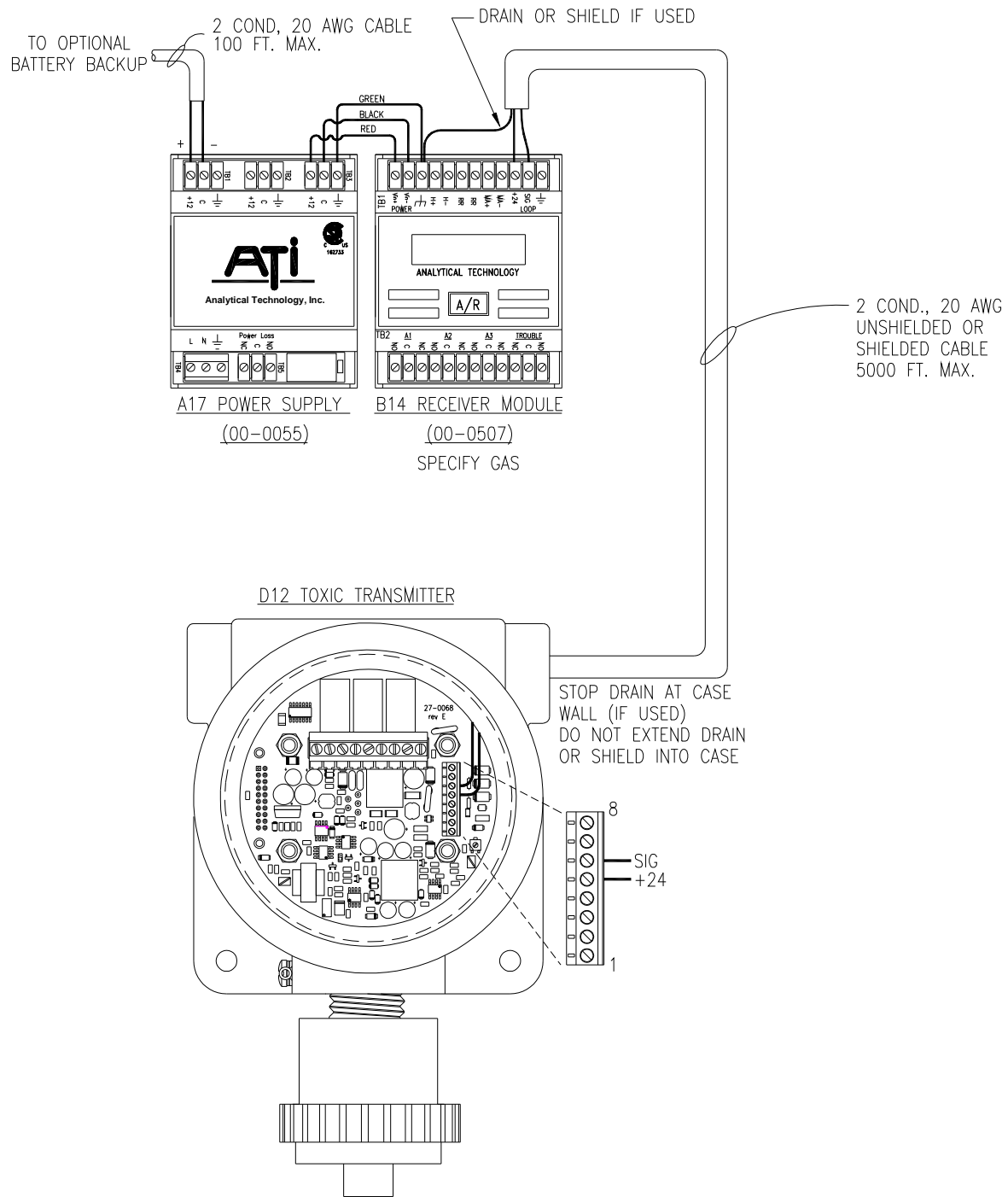

Figure 15 - Typical System Wiring, D12 Transmitter (2-Wire Hookup) (ATI-0610)

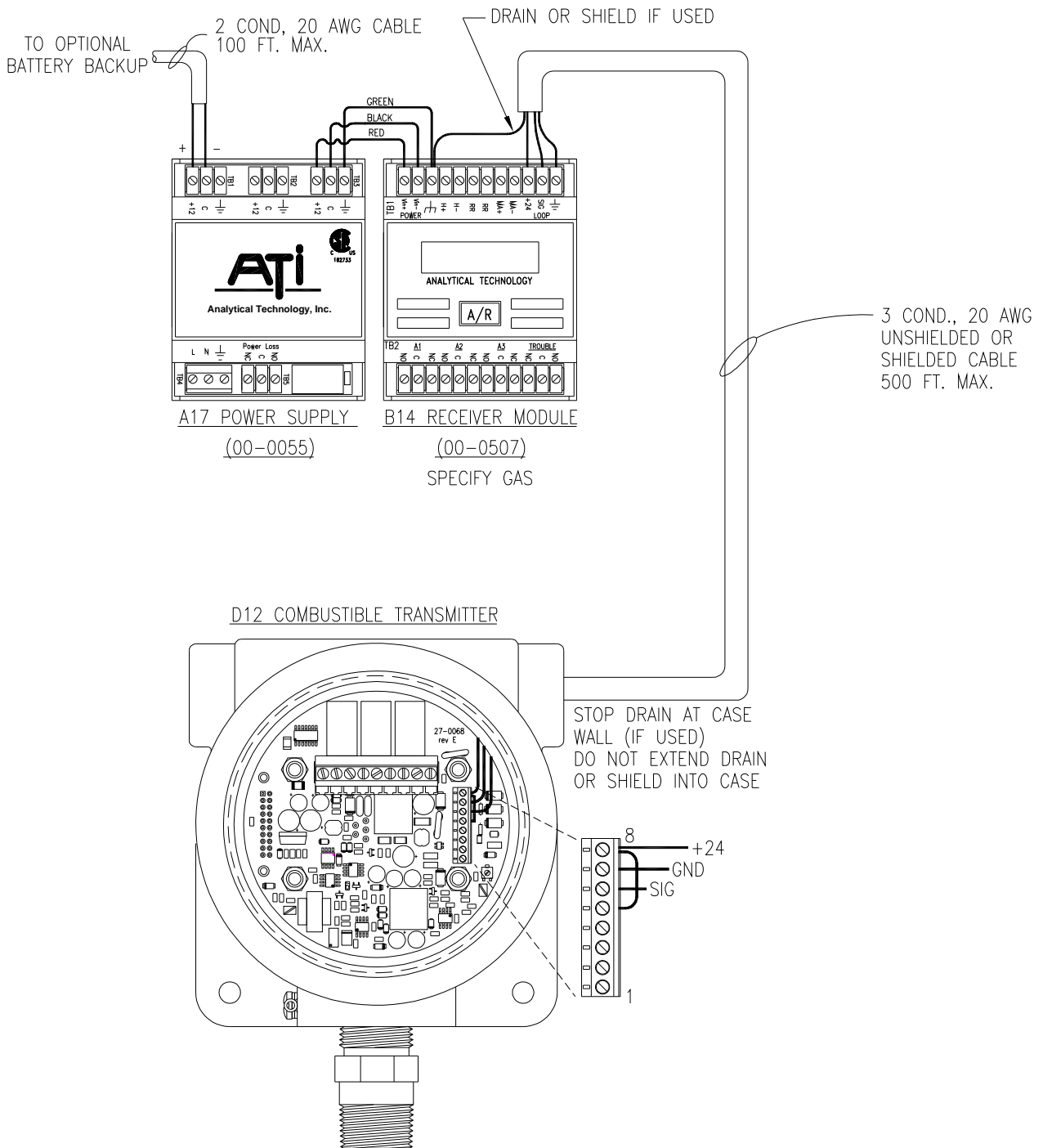

Figure 16 - Typical System Wiring, D12 Transmitter (3-Wire Hookup) (ATI-0611)

B14 RECEIVER MODULE

Series B14 Receivers provide alarm relay and display functions for the gas detection system. Each receiver is connected to one 2 or 3 wire sensor/transmitter, and displays information on the gas concentration in the sensor area. Receivers are powered by a separate 12 VDC power supply (part no. 00-0055) supplied as part of the system, or by a power supply furnished by the user (12-28 VDC only).

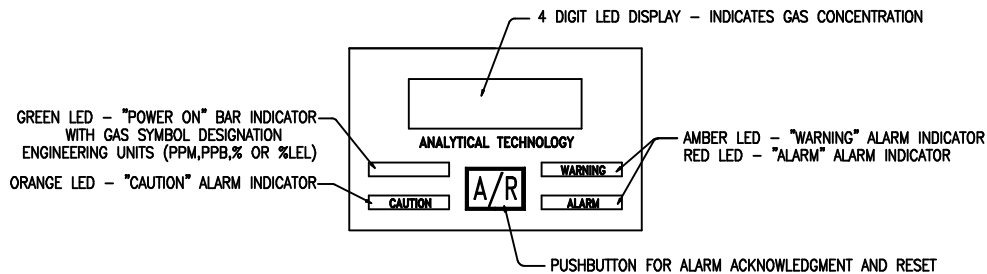

Figure 17 - Front Panel Controls & LEDs (ATI-0177)

Receiver modules also include the following standard features:

1. Three SPDT alarm relays, switch programmable for operating configuration.
2. One SPDT trouble relay, for remotely indicating that the TROUBLE alarm is activated.
3. Isolated 4-20 mA output signal proportional to gas concentration.
4. Isolated remote reset input terminals for remote alarm acknowledgment.
5. 24 VDC power for operation of either 2 or 3 wire transmitters.

Receivers are housed in a compact polystyrene case designed for mounting to a 35 x 7.5 mm DIN rail. The rails are supplied in standard ATI system enclosures, or can be supplied by a system integrator as part of a custom panel arrangement. A spring clip on the back of the enclosure holds the module to the rail. To remove from a rail, slide a thin bladed screwdriver through the black loop at the top of the module and pull outward until the module releases from the rail. To mount to the rail, reverse the procedure. When mounting, slide the bottom of the module against the bottom of the rail before extending the spring clip.

Electrical Connection

Electrical connections to the receiver are made to two pluggable terminal blocks as shown in Figure 18. Transmitter connections must be made at the time of installation, while power and horn connections are factory wired when the receiver is part of a complete system. Connections should be made and checked before power is applied to the module. Never connect or alter connections while power is on.

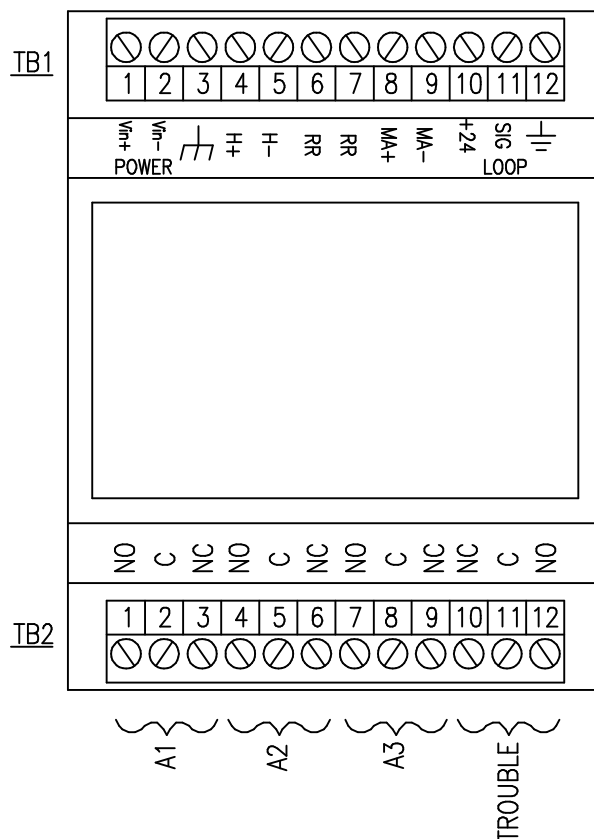

- | <u>TB1</u> | <u>TB2</u> |
|--------------------------------|--|
| 1: POWER Vin + | 1: A1 NO Alarm 1 normally open contact |
| 2: POWER Vin - | 2: A1 C Alarm 1 common |
| 3: Earth Ground (REQUIRED) | 3: A1 NC Alarm 1 normally closed contact |
| 4: H+ Audible Horn positive | 4: A2 NO Alarm 2 normally open contact |
| 5: H- Audible Horn negative | 5: A2 C Alarm 2 common |
| 6: RR Remote Reset | 6: A2 NC Alarm 2 normally closed contact |
| 7: RR Remote Reset | 7: A3 NO Alarm 3 normally open contact |
| 8: MA+ 4-20 mA output positive | 8: A3 C Alarm 3 common |
| 9: MA- 4-20 mA output negative | 9: A3 NC Alarm 3 normally closed contact |
| 10: +24 24V Loop Supply | 10: TROUBLE NC Trouble normally closed contact |
| 11: SIG Milliamp (+) Input | 11: TROUBLE C Trouble common |
| 12: Ground Milliamp (-) Input | 12: TROUBLE NO Trouble normally open contact |

NOTE: Relay contact designation is shown for relays in normal mode of operation for relays A1, A2, A3. If fail-safe relay operation is selected, NO and NC designations are reversed for that relay. The TROUBLE relay is set to fail-safe operation at the factory, and the designation shown above is for the trouble relay in fail-safe mode.

Figure 18 - Receiver Module Terminals (ATI-0178)

CAUTION: Receiver modules **MUST** be connected to a secure earth ground. Terminal 3 of TB1 in Figure 18 above must be connected to the earth ground terminal of ATI's power supply module as shown in the connection diagram in Figure 19. If the user is providing another power supply, be sure that the receiver is properly grounded.

Factory Configuration

All receivers are identical except for the gas symbol attached to the green power LED. Operating range, alarm relay configuration, and Fail setpoint are selectable using 6 banks of DIP switches located on the configuration circuit board inside the module.

Receivers are factory configured for the operating range specified on the customer order. Factory configuration of the relays is as follows:

Relay 1 - Configured to trip at the Caution setpoint (10% of Full Scale) and set for normal, non-latching operation.

Relay 2 - Configured to trip at the Warning setpoint and set for normal, non-latching operation.

Relay 3 - Configured to trip at the Alarm setpoint and set for normal, latching operation.

Alarm Delay - Configured for 2 second delay.

Caution, Warning and Alarm setpoints are factory set to standard values depending on the operating range. Except for oxygen systems, alarms are set to activate above the setpoints. Oxygen alarms are set to activate below the setpoints. Each alarm relay may be configured to activate either above or below the setpoint through proper DIP switch selection.

Configuration Switches

Figure 19 indicates the location of each bank of DIP switches labeled S1 thru S6 on the configuration P.C. board and Table 2-1 below, provides a description of the function of each switch on each bank.

TABLE 2-1

Bank A (S1) - Range

1	2	3	4	5	6	7	8
0=no 1=yes	0=no 1=yes	0=2 Sec. 1=10 Sec.	bit4	bit3	bit2	bit1	bit0
Blanking enabled	Horn on Trouble	CWA delay	Operating Range (see chart)				

Bank B (S2) - Caution

1	2	3	4	5	6	7	8
0=above 1=below	bit6	bit5	bit4	bit3	bit2	bit1	bit0
trip direction	Caution setpoint (% of full scale)						

Bank C (S3) - Warning

1	2	3	4	5	6	7	8
0=above 1=below	bit6	bit5	bit4	bit3	bit2	bit1	bit0
trip direction	Warning setpoint (% of full scale)						

Bank D (S4) - Alarm

1	2	3	4	5	6	7	8
0=above 1=below	bit6	bit5	bit4	bit3	bit2	bit1	bit0
trip direction	Alarm setpoint (% of full scale)						

Bank E (S5) - Relay Options

1	2	3	4	5	6	7	8
00=Caution 01=Warning 10=Alarm 11=Horn		0=NonLat. 1=Latching	0=Normal 1=FailSafe		00=Caution 01=Warning 10=Alarm 11=Horn	0=NonLat. 1=Latching	0=Normal 1=FailSafe
Relay 1 (A1) definition				Relay 2 (A2) definition			

Bank F (S6) - Relay Options

1	2	3	4	5	6	7	8
00=Caution 01=Warning 10=Alarm 11=Horn		0=NonLat. 1=Latching	0=Normal 1=FailSafe	00=below 3.7mA (-1.9%) 01=below 3.1mA (-5.6%) 10=below 2.4mA (-10%) 11=none		0=NonLat. 1=Latching	0=Normal 1=FailSafe
Relay 3 (A3) definition				Trouble detection		Relay 4 (Trouble) definition	

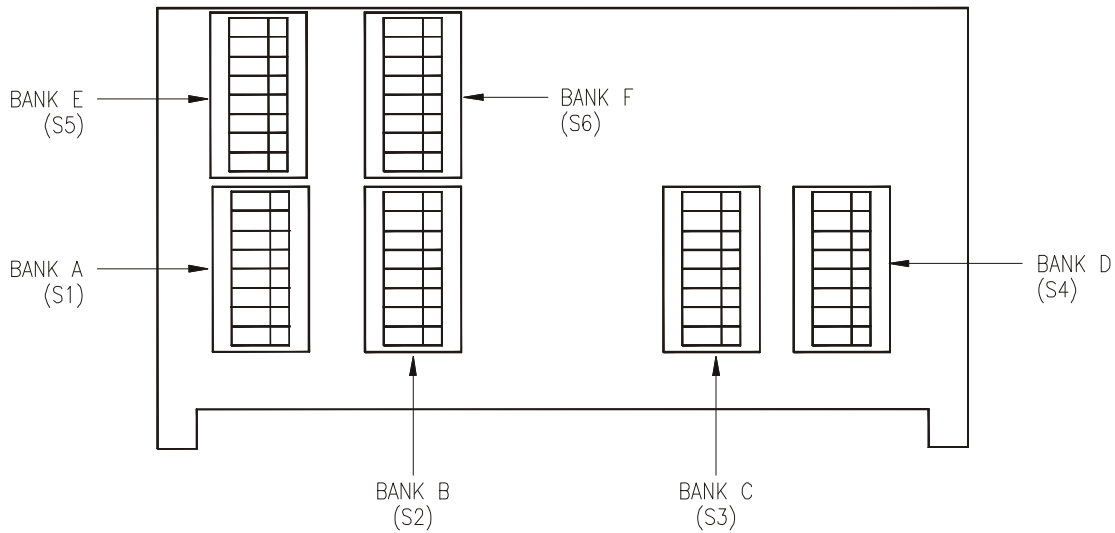

Figure 19 - Configuration Board Switch Location

Operating Range Chart

TABLE 2-2

Operating Range	bits 43210		Operating Range	bits 43210
0 - 1.00	00000		0 - 500	10000
0 - 2.00	00001		0 - 1000	10001
0 - 3.00	00010		0 - 1000 LSD Fixed	10010
0 - 4.00	00011		0 - 2000	10011
0 - 4.0	00100		0 - 2000 LSD Fixed	10100
0 - 5.0	00101		0 - 3000	10101
0 - 10.0	00110		0 - 3000 LSD Fixed	10110
2.0 - 12.0	00111		0 - 5000	10111
0 - 14.0	01000		0 - 5000 LSD Fixed	11000
0 - 20.0	01001		0 - 5.00	11001
0 - 25.0	01010		0 - 25.0 Oxygen (O ₂)	11010
0 - 30.0	01011		0 - 1.00 LSD Fixed	11011
0 - 50	01100		Reserved Display reads ' -- '	11100
0 - 100	01101			11101
0 - 200	01110			11110
0 - 300	01111		4.0 - 20.0	11111

Setpoint Selection

The operating range and the Caution, Warning and Alarm setpoints can be changed, if desired, by using the configuration switches identified in Table 2-1 on page 2-5. The Caution setpoint is set using switches B2-B8 labeled (S2), the Warning setpoint is set using switches C2-C8, labeled (S3) and the Alarm setpoint is set using switches D2-D8, labeled (S4). A binary number is used to select setpoints as a percent of operating range. For example, if you have a receiver range of 0-10 PPM and want to adjust a setpoint for 3 PPM, set the appropriate DIP switches to the binary number for 30% from Table 2-3 below. Switches can be set using a tool with a small point on one end. Viewed with the switch in the vertical position as shown in Figure 19, a switch to the left side indicates 'on' or a value of '1' and to the right indicating 'off' or a value of '0'. Caution, Warning, and Alarm can be disabled by setting switches 2-8 of the corresponding bank to the 'OFF' position.

TABLE 2-3

%	SWITCH POS.	%	SWITCH POS.	%	SWITCH POS.
disable	0000000				
d					
5	0000101	37	0100101	69	1000101
6	0000110	38	0100110	70	1000110
7	0000111	39	0100111	71	1000111
8	0001000	40	0101000	72	1001000
9	0001001	41	0101001	73	1001001
10	0001010	42	0101010	74	1001010
11	0001011	43	0101011	75	1001011
12	0001100	44	0101100	76	1001100
13	0001101	45	0101101	77	1001101
14	0001110	46	0101110	78	1001110
15	0001111	47	0101111	79	1001111
16	0010000	48	0110000	80	1010000
17	0010001	49	0110001	81	1010001
18	0010010	50	0110010	82	1010010
19	0010011	51	0110011	83	1010011
20	0010100	52	0110100	84	1010100
21	0010101	53	0110101	85	1010101
22	0010110	54	0110110	86	1010110
23	0010111	55	0110111	87	1010111
24	0011000	56	0111000	88	1011000
25	0011001	57	0111001	89	1011001
26	0011010	58	0111010	90	1011010
27	0011011	59	0111011	91	1011011
28	0011100	60	0111100	92	1011100
29	0011101	61	0111101	93	1011101
30	0011110	62	0111110	94	1011110
31	0011111	63	0111111	95	1011111
32	0100000	64	1000000	96	1100000
33	0100001	65	1000001	97	1100001
34	0100010	66	1000010	98	1100010
35	0100011	67	1000011	99	1100011
36	0100100	68	1000100	100	1100100

Range Selection

Display range selection sets the full scale operating range of the receiver. Table 2-2 on page 2-6, provides the proper switch settings for the ranges available on each receiver. Range selection is made using switches A4-A8, labeled (S1). The 4-20 mA output signal is proportional to the selected range. Ranges marked with 'LSD Fixed' indicate that the least significant digit on the display always reads zero.

Relay Configuration

Receivers contain 3 SPDT alarm relays that actuate based on gas concentration. Alarm setpoint relays can be set to actuate when the gas concentration either goes above or falls below the setpoint. Most gas leak detection applications require alarms to activate above a specific setpoint, but alarms for oxygen deficiency require relay actuation below the setpoints. Each contains a switch that selects whether that activates above or below the setpoint. Switch B1 labeled (S2), controls Caution, switch C1, labeled (S3) controls Warning, and switch D1 labeled (S4), controls Alarm as shown in Figure 19 on page 27.

Each relay can be assigned to the caution, warning or alarm setpoint. As shown in Figure 19, switches E1-2, E5-6, labeled (S5), and F1-2 labeled (S6), can be used to assign the relays to a particular setpoint. When caution is selected, the relay will activate when the caution lamp on the front panel lights. When warning is selected, the relay will activate when the warning lamp on the front panel lights. When alarm is selected, the relay will activate with the alarm lamp on the front panel.

Relays may be either Latching or Non-latching. A latching relay activates when gas concentration exceeds the setpoint, but will only deactivate when the **A/R** button is pressed, and then only if the gas concentration has fallen below the setpoint. A non-latching relay will automatically deactivate when the gas concentration falls below the setpoint without **A/R** button being pressed. Selection of the latch/non-latch function uses switches E3, E7, labeled (S5), F3, and F7 labeled (S6).

Relays may be configured for either Fail-safe or Normal operation. The designation of normal or fail-safe refers to the operation of the relay coil during normal operation. A relay configured for Normal operation will have the relay coil energized when an event occurs and de-energized during normal operation. A relay configured for Fail-safe operation has the relay coil energized when conditions are normal and de-energizes when an event occurs. A fail-safe relay will change state if power to the receiver is interrupted. Selection of the fail-safe function uses switches E4, E8, labeled (S5), F4, and F8 labeled (S6).

A short time delay precedes the activation of caution, warning, and alarm relays when a setpoint is exceeded. This brief delay of 2 seconds eliminates false alarms due to transients that might be encountered in a particular installation. The 2 second delay is the factory default and is selected with switch A3 labeled (S1). A 10 second delay may be selected if required in a specific application. The delay time of either 2 or 10 seconds affects the caution, warning, and alarm lamps and their associated relays.

External Horn Relay

Relays in the B14 receiver provide an additional configuration option for external horn activation. Switches E1-2, E5-6 labeled (S5), and F1-2, labeled (S6), allows relays to be configured for “HORN” mode of operation. When a relay is configured for this mode, it will operate in parallel with the internal horn. This means that any external horn tied to that relay will sound intermittently when the warning setpoint is exceeded or trouble is detected and will go to steady on when the alarm setpoint is exceeded. The relay will deactivate when the **A/R** switch is pressed, silencing the external horn. Neither the internal or an external horn will sound when the caution setpoint is reached.

Using a relay in the horn configuration eliminates the need for additional relay logic to silence an external horn. This can provide significant cost savings in the installation of a complete alarm system.

OPERATION

Receiver front panels contain four LED bar indicators and a 4 digit LED display. The digital display indicates gas concentration in either PPM, PPB, or percent. The green LED bar is marked with the gas symbol and units of measurement (PPM, PPB, % or % LEL) specified on the customer order. LED bars also indicate CAUTION, WARNING, and ALARM conditions.

When power is first applied, the LED display will turn on and will step through four information displays. The first number displayed is the full scale range. A 0-10 PPM unit will be indicated by "10.0" on the display. After 3 seconds, the display will indicate the caution setpoint, with the CAUTION lamp illuminated. After 3 seconds, the display will indicate the warning setpoint, with the WARNING lamp illuminated. After 3 seconds, the display will indicate the alarm setpoint, with the ALARM lamp illuminated. After 3 seconds, the display will indicate the software revision level, (r x.x). At the end of this sequence, the display will begin to indicate gas concentration. However, all alarm functions and 4-20mA output will be inhibited for 5 minutes while the system is allowed to stabilize. This is indicated by CAUTION, WARNING and ALARM lamps flashing in an sequential pattern. During this period, alarms will not function, but the display will indicate the presence of any gas that might be in the area of the sensor. Normally, the display will spike when power first comes on, and will slowly recover to zero over the 5 minute period in which alarms and 4-20mA output are inhibited. The 5 minute inhibit can be bypassed by pressing the **A/R** switch at any time during the inhibit time-out.

Alarm Acknowledge and Reset

The front panel of the receiver contains one button, marked **A/R**, which is used for a number of different functions. When the receiver is in normal operation, a gas leak that exceeds the caution setpoint will cause the CAUTION indicator to flash. Any relays assigned to caution will activate. Pressing the **A/R** button will change the indicator to a steady on indication. Exceeding the warning setpoint will cause the WARNING indicator to flash and the internal horn to sound intermittently. If the alarm setpoint is exceeded, the ALARM indicator will flash and the horn will sound steadily. Pressing the **A/R** button the first time will silence the audible horn, and will change the WARNING and ALARM indicators from flash to steady on. The indicator lamps will remain lit until the gas condition has cleared. The CAUTION and WARNING indicators will automatically shut off when gas concentration falls below the setpoint, but the ALARM indicator will remain lit. Pressing the button after the alarm condition has cleared will reset the ALARM indicator.

Operation of the individual relays depends on the configuration selected for each one. As shipped from the factory, relay A1 will energize when the CAUTION indicator lights and will automatically reset when the gas condition clears and the CAUTION indicator shuts off. Relay A2 will energize when the WARNING indicator lights and will automatically reset when the gas condition clears and the WARNING indicator shuts off. Relay A3 will energize and latch when the ALARM indicator lights. This relay will reset when the **A/R** button is pressed to reset the ALARM indicator. Changes in the relay configuration switches will alter this operational sequence.

Trouble Alarm and Relay

Receivers contain a TROUBLE indicator and an associated SPDT relay. The trouble alarm will be activated if the 4-20 mA input falls below a preset limit. If this condition occurs, the POWER lamp will flash, the horn will sound intermittently, and the trouble relay will change state. The TROUBLE relay can be configured to be latching (F7) and failsafe (F8). The horn function associated with the trouble alarm can be deactivated by changing the position of switch A2 (see Table 2-1) on page 2-5.

The setpoint for the trouble detection circuit can be selected for values below 3.7 mA, below 3.1 mA, below 2.4 mA, or turned off completely. This is done using switches F5-6, labeled (S6). ATI series A12 transmitters operate between 4 and 20mA and provide an output of 3.0 mA on trouble, so the below 3.1 mA configuration should be used. Series B12 transmitters operate between 4 and 20mA, do not have a trouble output, but can go under range to 3.6mA with large sensor offsets, so a configuration of below 3.1 mA should also be used for this type of input. In each case, a break in the loop wiring will cause a trouble alarm. If another brand of transmitter is connected to a B14 receiver, contact the transmitter manufacturer for information on available trouble signals.

Lamp and Horn Test

Verification that all display segments and alarm indicator bars are functional is done using the **A/R** button to initiate a lamp test. If the detection system includes an internal horn, the horn is also tested as part of the lamp test.

To activate the lamp test, press and hold the **A/R** button for approximately 3 seconds and all front panel indicators will light. The horn will also sound briefly. Immediately release the button and the indicators will return to normal.

The operating range, caution, warning, and alarm setpoints can be displayed at the end of this test. See the Inhibit Mode section below.

Inhibit Mode

Alarm relays and 4-20mA output in the receiver can be inhibited for up to 4 hours to allow calibration or testing of sensor/transmitters without activating external alarm or control devices. Alarm inhibit is activated through the use of the **A/R** button.

Press and hold the button for approximately 3 seconds. The lamp test will occur first, but continue to hold the button down. Once the lamps have shut off, release the button. The CAUTION, WARNING and ALARM lamps will begin a sequential pattern. If the A/R button is pressed and released, the receiver will go into the inhibit mode (if a horn is connected, a quick beep will sound when the inhibit is selected). If the button is not pressed within 5 seconds, the unit will display the operating range, caution setpoint, warning setpoint, alarm setpoint, and software revision level, then revert to the normal operating mode.

The CAUTION, WARNING and ALARM lamps will continue their sequential flash, and will continue for 4 hours or until the **A/R** button is pressed again. During this period, the display will indicate gas concentration, but the relays will not activate and the 4-20mA output will not change. Transmitters may be calibrated while the inhibit is on without activating external alarms.

Remote Reset

Receivers are provided with input terminals for connection of a remote reset switch. The remote reset input provides horn silence and alarm reset functions using a switch located at a remote point. When receivers are located at sites with telemetry equipment, the remote reset input may be connected to a relay contact in the telemetry system.

The remote reset input accomplishes the same acknowledge and reset functions as the **A/R** button on the front panel. When a switch closure is detected across the remote reset terminals, the detector horn will silence and any latching relays will reset, provided that the gas condition has cleared. The remote reset input will not activate any of the testing or inhibit functions of the receiver.

Analog Output

Receivers provide an isolated 4-20 mA output signal for interface with recorders, data loggers, or computer systems. The span of the 4-20 mA signal is the same as the range of the receiver selected during the receiver configuration. The output will drive loads up to 1200 ohms. On trouble condition, the output signal will go to 3mA until the condition is cleared and the trouble alarm is acknowledged.

In Inhibit Mode, the output signal is held at 4mA for all gases except oxygen (range dip switches A4-A8 set for '11010') where the signal is held at 17.4mA (20.9% O₂).

Troubleshooting

Receiver modules will normally provide trouble free operation over many years of service. However, should problems arise, a few simple tests can be done to determine if the receiver is functioning properly.

LED display and green gas indicator do not light when power is applied to the system.

1. Check polarity of the power connection at terminals 1 and 2 of TB1. Terminal 1 must be positive and terminal 2 must be negative.
2. With a voltmeter, check the power supply at terminals 1 and 2 of TB1. Input power supply must be between 12 and 28 VDC.

Receiver module powers up correctly, but does not respond when test gas is applied to sensor/transmitter.

1. Check the voltage on 10 and 12 terminals of TB1 with a voltmeter. The voltage should be about 24 VDC.

Problems in the receiver module can only be caused by an electronic component failure. In most cases, the simplest solution is to remove the module and install a replacement. Troubleshooting the electronic circuit boards is best handled by trained technician familiar with the circuits. As modules are small and easily shipped, it is best to return defective modules to ATI for service.

Modules failing during the warranty period will be exchanged by ATI with replacement units. Contact the ATI service department for assistance.

RECEIVER MODULE PARTS LIST

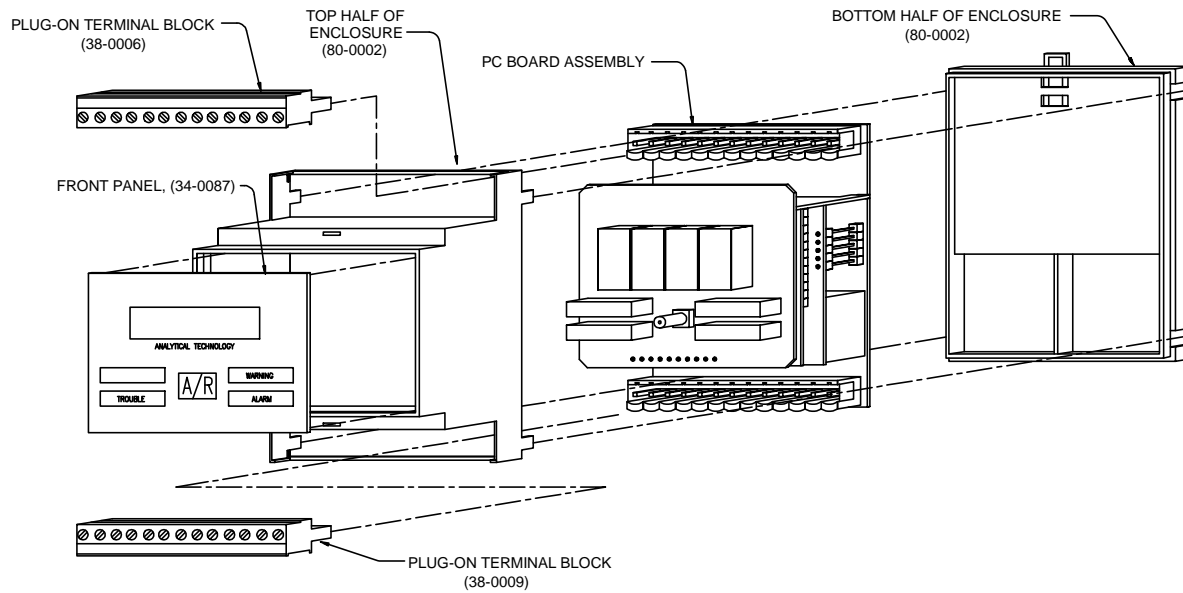

<u>Part Number</u>	<u>Description</u>
00-0507 *	Complete receiver module
03-0113	Printed circuit board assembly
80-0002	Module enclosure (top and bottom)
34-0087	Front panel
38-0009	Relay terminal block plug, 12 position
38-0006	DC terminal block plug, 12 position

Items marked with an asterisk (*) are recommended spares.

UNIVERSAL POWER SUPPLY

The power supply module used in the B14 system (part #00-0055) is a self-adjusting supply that will accept the AC power provided in virtually every country in the world. Any AC (50-60 Hz.) or DC voltage from 85 volts to 270 volts can be connected to the power input terminals on TB 4. There are no adjustments of any kind required.

The output of the power supply is a regulated 13.7 VDC. There are 3 sets of DC terminals at the top of the module for connection to receivers and external battery back-up units. This voltage permits float charging of a separate 12 volt lead acid battery for detector system back-up. Power supply modules are rated for 1 ampere output, and will deliver higher current for short periods. Each receiver module draws a maximum of approximately 300 mA, and will normally draw about 125 mA. An external battery back-up unit can draw up to 750 mA for a few hours if the battery is deeply discharged, but the current draw drops sharply as the battery approaches full charge. The audible horn draws less than 10 mA average current, and an optional strobe will draw approximately 400 mA when activated.

The power supply is internally fused at 2 amps. The fuse is not user replaceable. (note: Only qualified service personnel will replace the fuse, using the same type and rating as indicated on the fuse).

The power supply has a power-on indicator LED and provides a SPDT relay to indicate power failure. The relay coil is energized by power from the primary (TB5) terminals and will de-energize if primary power is lost. This relay is convenient for input to telemetry systems to indicate loss of primary power at a remote site.

Mounting of power supply modules is done by clipping them to a standard 35 x 7.5 mm DIN rail. A spring loaded clip holds the module to the rail and is used for mounting and removal. From the front, the clip is seen as a black loop at the top rear of the module. To remove from a rail, place a small screwdriver into the opening in the black loop and pull outward until the module releases from the rail. Reverse the procedure to mount the module.

CAUTION

The power supply module is sealed, and the seal should not be broken. Never attempt to disassemble or service the power supply module. Service on this module should only be done only by a qualified service technician familiar with the circuit design and equipped with the proper service equipment. Severe electrical shock or death may result from touching internal components with input power applied.

Figure 20 provides detailed information on the terminals provided on the power supply. All terminal blocks are plug-in type, and can be easily unplugged should removal of the module be necessary.

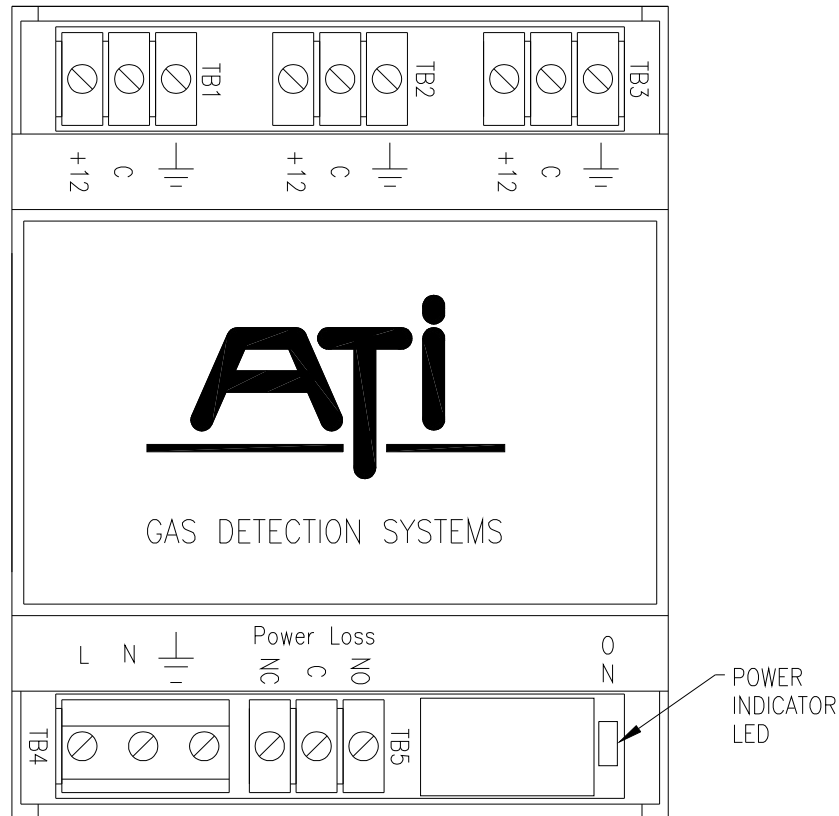

- | | | |
|--|---|-----------------------------|
| <u>TB1</u>
(12V Battery only) | <u>TB2</u> | <u>TB3</u> |
| 1: +12 External Battery (+) | 1: +12 Receiver Module (+) | 1: +12 Receiver Module (+) |
| 2: C External Battery (-) | 2: C Receiver Module
Common | 2: C Receiver Module Common |
| 3: Earth Ground | 3: Earth Ground | 3: Earth Ground |
| <u>TB4</u> | <u>TB5</u> | |
| 1: L AC power hot (85-255 VAC) | 1: NC Power failure normally closed contact | |
| 2: N AC power neutral | 2: C Power failure common | |
| 3: AC power ground (earth ground REQUIRED) | 3: NO Power failure normally open contact | |

NOTE: AC power input must be properly earth grounded for safe operation. 220 VAC power without a neutral line may not be used with this power supply.

Figure 20 - Power Supply Terminal Connections (ATI-030)

POWER SUPPLY PARTS LIST

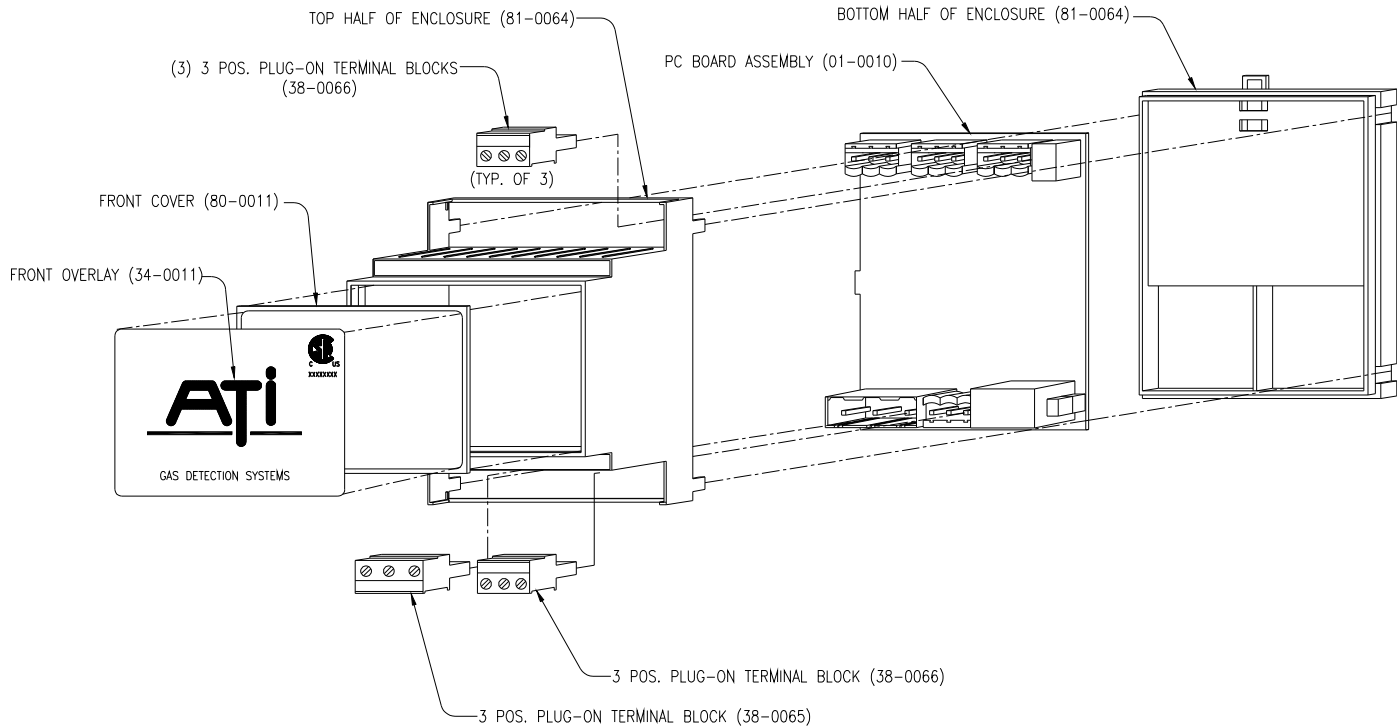

Part Number

Description

00-0055 *	Complete power supply module
01-0010	Power supply circuit board assembly
81-0046	Module enclosure (top and bottom)
34-0011	Front Overlay
38-0065	AC power terminal block plug, 3 position
38-0066	Power failure relay & DC terminal block plug, 3 position
80-0011	Front Cover

Items marked with an asterisk (*) are recommended spares.

BATTERY BACK-UP UNIT

Battery back-up units for B14 detection systems (part #00-0057) are separate components housed in a NEMA 4X wall mount enclosure. Back-up units include a 4 ampere-hour sealed lead acid battery with a control circuit attached to the battery terminals. The battery is held in place on an aluminum bracket fixed to the plastic enclosure.

Installation

Figure 21 shows the dimensions of the battery back-up unit and the mounting hole centers. Two conduit hubs are supplied with the unit, one for use on the battery back-up enclosure and one for use on the receiver enclosure. **When mounting the battery back-up unit, be careful to hold the module securely when screwing the enclosure in place. The battery is heavy and could cause injury to feet if it should fall directly on them.** The battery and attached circuit board are held in place with a wire tie. Should you wish to remove the battery, the wire tie must be cut. When replacing the battery, secure with a new wire tie. Replacement batteries from ATI are supplied with the proper wire tie.

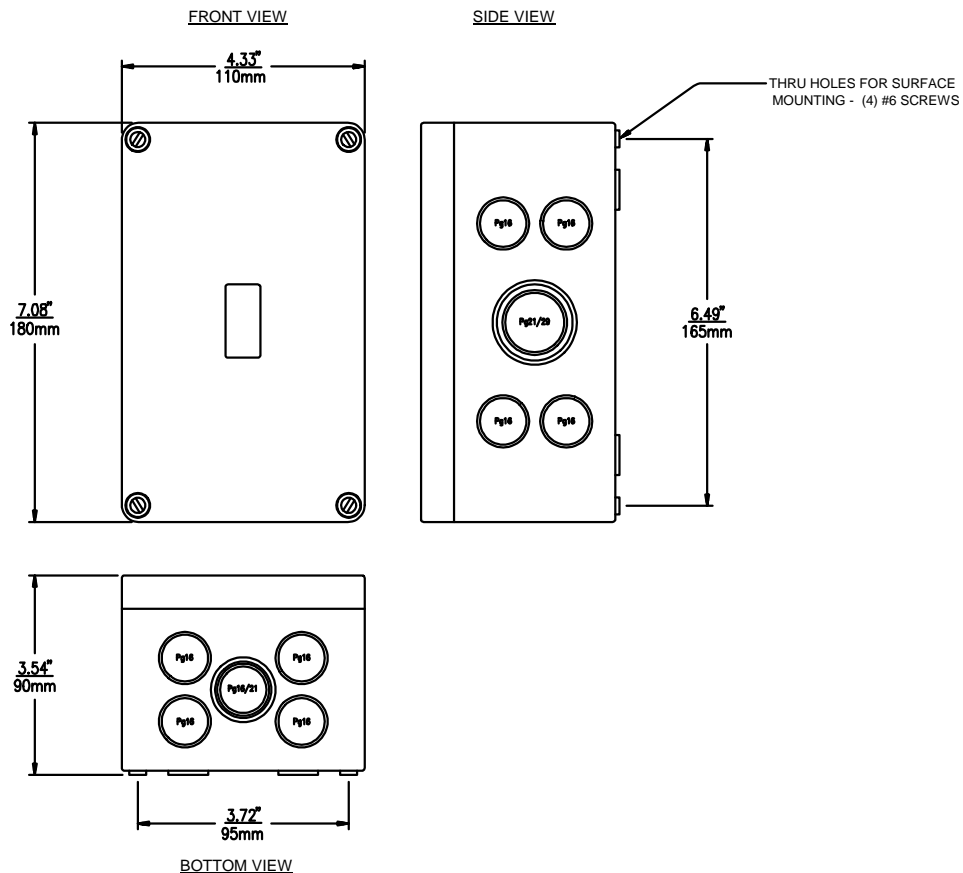

Figure 21 - Battery Back-up Mounting Dimensions

Electrical connection is made between the battery back-up unit and the power supply module. The circuit board mounted on the battery contains a 2 position plug-in terminal block marked plus and minus. The plus terminal is connected to terminal B+ of the power supply and the minus terminal is connected to B- of the power supply.

Operation

When power is applied to the power supply module, a relay on the battery back-up circuit board energizes and places the battery back-up into operation. There are no user adjustments in the battery back-up unit. If the battery is not fully charged, the power supply will begin supplying charge current to the battery, and will float charge the battery as long as the power supply is on.

Should the power supply lose its input power, the battery back-up will immediately supply power to receiver modules to maintain detection system operation without interruption. The back-up period will vary depending on whether the detector is single channel or two channel, and on how many relays are configured for fail-safe operation. The minimum period expected for a single channel system is 12 hours and for a two channel system is 6 hours. Normally, the back-up period is twice as long as the minimums.

The circuit board attached to the battery serves two functions. First, it regulates the charging current to the battery to a maximum of 0.75 amps. This prevents possible damage to the battery due to an excessively high charge current. Second, it isolates the battery from the detection system when the battery voltage falls below 10 volts. This is done through a relay, and protects the battery against damage caused by very deep discharge.

The isolation relay that protects against deep discharge will also protect the battery against an external short circuit of the wires connected to the battery. If a short occurs, the relay will immediately open, protecting the battery and limiting the current that the battery will deliver.

Removal from Service

The relay that isolates the battery when the 10 volt level is reached is energized as soon as power is applied to the power supply module. Once energized, the coil current is supplied from the battery if needed. If the gas detection system supported by the battery back-up is started up for testing and then shut down, the battery back-up relay should be de-energized manually. Otherwise, the relay coil will continue to draw power from the battery until the 10 volt level is reached. While this will not cause damage, it means that the battery will be discharged when the detection system is started up again.

To de-energize the relay, slide the control circuit board off the battery terminals briefly and then slide it back on. As soon as the battery connection is broken, the relay coil will drop out, and will not energize until power is applied to the power supply module in the system. This procedure is recommended any time the detection system is to be shut down for more than a few days.

BATTERY BACK-UP PARTS LIST

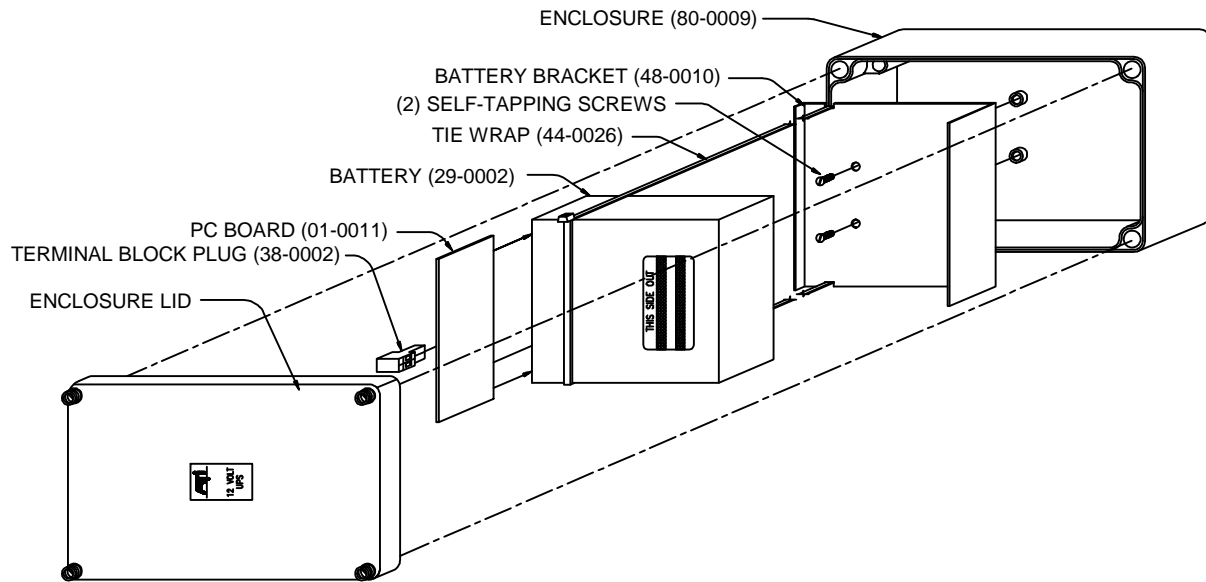

<u>Part Number</u>	<u>Description</u>
00-0057	Complete battery back-up unit
01-0011	Battery back-up circuit board
80-0009	NEMA 4X enclosure (top and bottom)
48-0010	Battery bracket
29-0002	Battery, 12 V, 4 A-H
41-0011	Self-tapping screws
44-0017	1/2" NPT conduit hub

STROBE LIGHT

The accessory alarm indicating strobe light (part number 35-0002) available for use with the B14 alarm system is a weatherproof high-intensity strobe operating from a 12-80 VDC power source. The strobe can be conveniently mounted on the top or either side of the alarm enclosure using one of the ½” NPT hubs supplied with the unit. The bottom of the strobe also contains a ½” NPT mounting adapter, so that only a ½” pipe nipple is needed to complete the assembly. The necessary nipple is available from most hardware stores or plumbing supply outlets.

For remote applications, the strobe should be mounted to ½” conduit, with a junction box nearby for splicing the strobe wires to the interconnect wiring running to the alarm unit. This wiring should be kept separate from AC power wiring to avoid accidental connection of AC power to the strobe, which will damage the lamp.

The power to operate the strobe can be picked up from the power supply module which is part of the alarm unit. Figure 22 shows the typical wiring diagram for connection of the strobe. The wiring diagram shows the plus side of the supply brought to the common of the alarm contact, one side of the strobe wired to the normally open (NO) contact, and the other side of the strobe connected to the minus side of the supply. Connection of the strobe lamp directly across the alarm relay will not operate the strobe because alarm contacts are unpowered.

CAUTION: Strobe light connection is polarity sensitive. Check wiring to be sure that the + power supply terminal is connected to the red strobe wire.

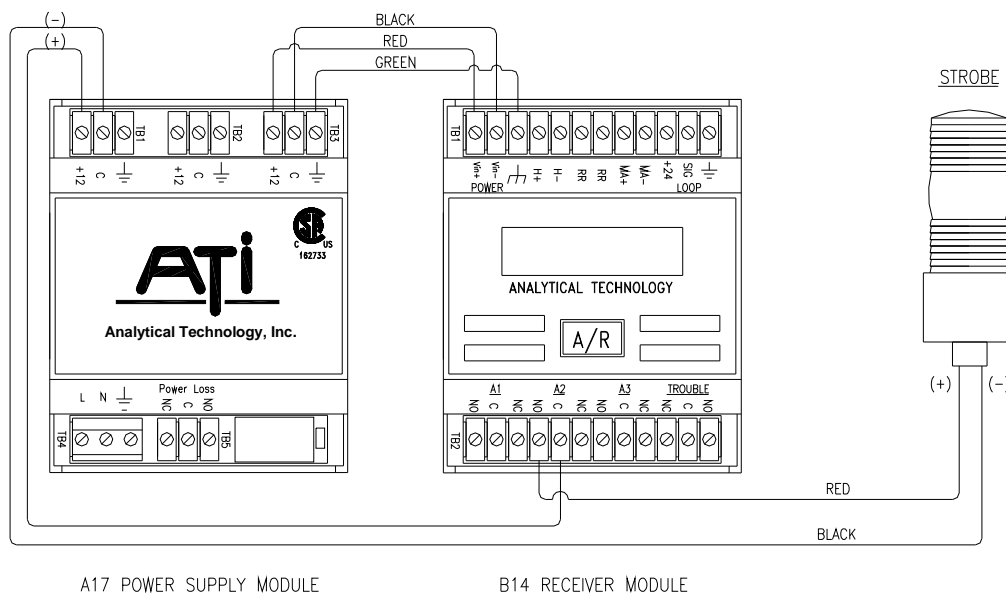

Figure 22 - External Strobe Light Connections (ATI-0202)

STROBE PARTS LIST

<u>Strobe p/n</u>	<u>Strobe Description</u>
35-0002	Red Strobe, 12-80 VDC
35-0005	Red Strobe, 120 VAC
35-0004	Amber Strobe, 12-80 VDC
35-0006	Amber Strobe, 120 VAC

PRODUCT WARRANTY

Analytical Technology, Inc. (Manufacturer) warrants to the Customer that if any part(s) of the Manufacturer's equipment proves to be defective in materials or workmanship within the earlier of 18 months of the date of shipment or 12 months of the date of start-up, such defective parts will be repaired or replaced free of charge. Inspection and repairs to products thought to be defective within the warranty period will be completed at the Manufacturer's facilities in Collegeville, PA. Products on which warranty repairs are required shall be shipped freight prepaid to the Manufacturer. The product(s) will be returned freight prepaid and allowed if it is determined by the manufacturer that the part(s) failed due to defective materials or workmanship.

This warranty does not cover consumable items, batteries, or wear items subject to periodic replacement including lamps and fuses.

Gas sensors carry a 12 months from date of shipment warranty and are subject to inspection for evidence of misuse, abuse, alteration, improper storage, or extended exposure to excessive gas concentrations. Should inspection indicate that sensors have failed due to any of the above, the warranty shall not apply.

The Manufacturer assumes no liability for consequential damages of any kind, and the buyer by acceptance of this equipment will assume all liability for the consequences of its use or misuse by the Customer, his employees, or others. A defect within the meaning of this warranty is any part of any piece of a Manufacturer's product which shall, when such part is capable of being renewed, repaired, or replaced, operate to condemn such piece of equipment.

This warranty is in lieu of all other warranties (including without limiting the generality of the foregoing warranties of merchantability and fitness for a particular purpose), guarantees, obligations or liabilities expressed or implied by the Manufacturer or its representatives and by statute or rule of law.

This warranty is void if the Manufacturer's product(s) has been subject to misuse or abuse, or has not been operated or stored in accordance with instructions, or if the serial number has been removed.

Analytical Technology, Inc. makes no other warranty expressed or implied except as stated above.

WATER QUALITY MONITORS

Dissolved Oxygen
Free Chlorine
Combined Chlorine
Total Chlorine
Residual Chlorine Dioxide
Potassium Permanganate
Dissolved Ozone
pH/ORP
Conductivity
Hydrogen Peroxide
Peracetic Acid
Dissolved Sulfide
Residual Sulfite
Fluoride
Dissolved Ammonia
Turbidity
Suspended Solids
Sludge Blanket Level

MetriNet Distribution Monitor

GAS DETECTION PRODUCTS

NH ₃	Ammonia
CO	Carbon Monoxide
H ₂	Hydrogen
NO	Nitric Oxide
O ₂	Oxygen
CO	Cl ₂ Phosgene
Br ₂	Bromine
Cl ₂	Chlorine
ClO ₂	Chlorine Dioxide
F ₂	Fluorine
I ₂	Iodine
H _x	Acid Gases
C ₂ H ₄ O	Ethylene Oxide
C ₂ H ₆ O	Alcohol
O ₃	Ozone
CH ₄	Methane (Combustible Gas)
H ₂ O ₂	Hydrogen Peroxide
HCl	Hydrogen Chloride
HCN	Hydrogen Cyanide
HF	Hydrogen Fluoride
H ₂ S	Hydrogen Sulfide
NO ₂	Nitrogen Dioxide
NO _x	Oxides of Nitrogen
SO ₂	Sulfur Dioxide
H ₂ Se	Hydrogen Selenide
B ₂ H ₆	Diborane
GeH ₄	Germane
AsH ₃	Arsine
PH ₃	Phosphine
SiH ₄	Silane
HCHO	Formaldehyde
C ₂ H ₄ O ₃	Peracetic Acid
DMA	Dimethylamine