



**made of Stainless Steel**

## **HIGH VISCOSITY DRUM PUMPS**

**Eccentric Screw Pumps  
for highly viscous liquids**



**The right pump for**

- fixed applications**
- mobile applications**
- easy to clean for multiple applications**
- operating in hazardous locations**

# Grün High Viscosity Pumps go along with you through thick and thin



High viscosity pumps in operation...



with paint, glue and in hazardous locations

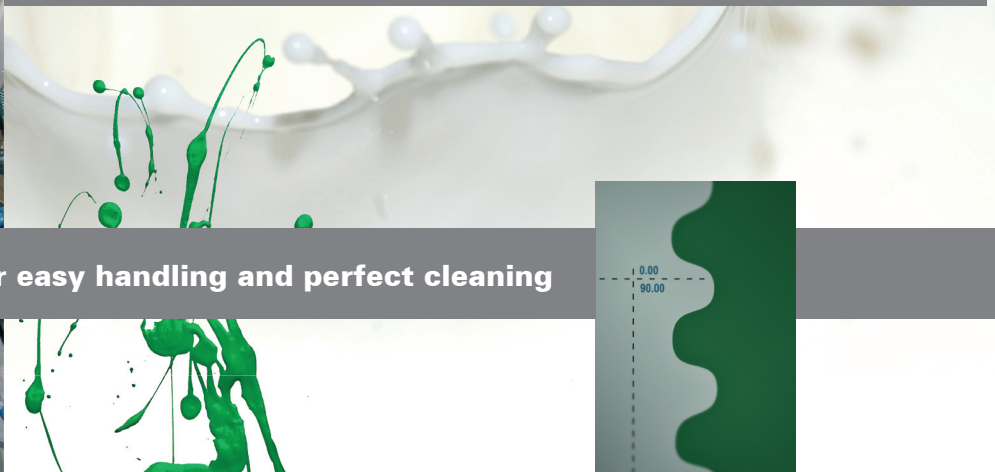

special thread for easy handling and perfect cleaning



# A stepped programm for a wide choice of applications

4 versions of the pump for mounting inside and outside drums and containers

## Version rigid dedicated for fixed applications

- : motor and pump fixed coupled
- : easy to handle with spring balancer (lifting device)
- : special thread for simple disassembly (service, cleaning)
- : less parts, competitive price



## Version QCC (Quick Change Coupling) ideal for mobile applications

- : simple motor and pump separation
- : easy handling of motor and pump (separated)
- : no spring balancer (lifting device) necessary
- : one motor suitable for different pumps
- : special thread for simple disassembly (service, cleaning)

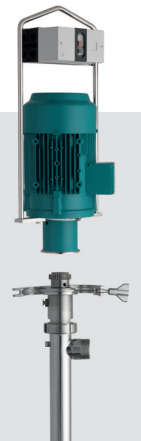

## Version SD (Simple Disassembly) functional design for frequent disassembly (service, cleaning)

- : simple motor and pump separation
- : separable drive shaft for easy cleaning and service in multiple applications
- : easy disassembly of the pump without tools or training
- : special thread for simple disassembly (service, cleaning)



## Version EX (Explosion proof) with safe use in hazardous locations

- : Ex-proof certification ATEX
- : certification for highly combustible liquids
- : simple motor and pump separation
- : special thread for simple disassembly (service, cleaning)



# HIGH VISCOSITY DRUM PUMPS

**Eccentric Screw Pumps made of Stainless Steel for highly viscous liquids**

Ord.-No.

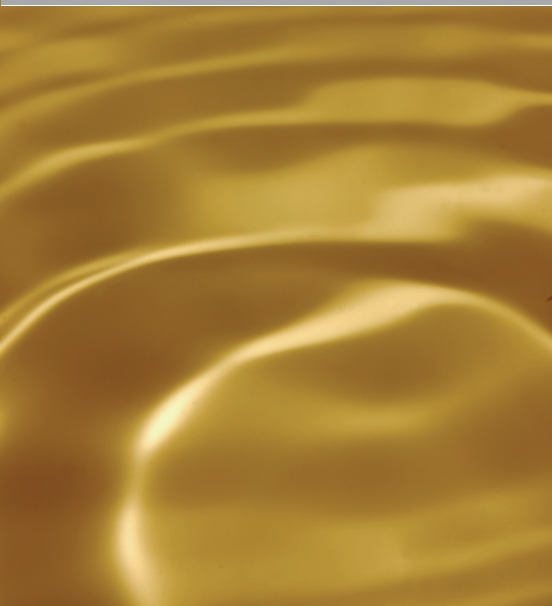

Reference values for the right pump						
Liquid	Viscosity	Temp.	Gasket	Stator	Rotation speed	Q max
	mPas	°C			rpm	l/min
honey	2.500	40 °C	MS*	NBR	900	50
liquid soap	4.000	20 °C	MS	NBR	900	50
fruit concentrates	1.600	20 °C	MS	NBR	900	50
glucose	20.000	35 °C	MS	NBR	900	50
glycerin	1.500	20 °C	MS	NBR	900	50
hand cream	8.000	20 °C	MS	NBR	900	50
resins	10.000	20 °C	MS	PTFE	900	50
jam, marmelade	8.500	20 °C	MS	NBR	900	50
cosmetics	20.000		MS	PTFE	900	50
paint	10.000		MS	PTFE	900	50
glue	4.000	20 °C	SB**	NBR	900	50
molasse	100.000		SB	NBR	300	5
mineral oil	10.000		MS	NBR	900	50
vegetable oil	2.000	20 °C	MS	NBR	900	50
polyole	60.000	20 °C	SB	NBR	500	14
shampoos	3.000	20 °C	MS	NBR	900	50
paste	50.000		MS	NBR	500	14
tomato purree	4.000	20 °C	MS	NBR	900	50
tomato ketchup	1.500	20 °C	MS	NBR	900	50
tooth paste	>70.000	40	SB	PTFE	300	5

\* MS: mechanical seal

\*\* SB: stuffing box

Description

Application

Advantages

Price

Recommendation





Motor-Pump with bayonet coupling	Motor-Pump rigid coupled	Motor-Pump with quick change coupling (QCC)	Pump for simple disassembly (SD)	Pump with Ex-Certification
----------------------------------	--------------------------	---------------------------------------------	----------------------------------	----------------------------

652-.....	650-.....	651-.....	654-.....	653-.....
-----------	-----------	-----------	-----------	-----------



Light version of the eccentric pump, disconnection of motor-pump by quarter turn of the clamping ring	Motor-pump is one fixed coupled unit	Motor-Pump with QCC coupled, motor-pump separable without tools, patent-registered solution	Design like QCC, additional separable drive shaft for quick pump disassembly, no tools needed, extreme short overall length possible	ATEX Ex II 1/2 G c IIB T4, design like QCC, additional universal-joint shaft, PTFE-Stator and MS adapted to Ex-requirements
-------------------------------------------------------------------------------------------------------	--------------------------------------	---------------------------------------------------------------------------------------------	--------------------------------------------------------------------------------------------------------------------------------------	-----------------------------------------------------------------------------------------------------------------------------

Low flow rate, medium viscosities, mobile operation, for frequent drum change, using one motor and several pumps	Fixed installation in containers and facilities, seldom moving the pump (weight)	Mobile operation of the pump, frequent moving of the pump, one motor for several pumps	Application like QCC additional frequent disassembly of the pump (cleaning, service, etc), cleaning in washing machines, special applications outside of drums, containers, tanks	Application like QCC additional operation in hazardous locations, pumping highly combustible liquids
------------------------------------------------------------------------------------------------------------------	----------------------------------------------------------------------------------	----------------------------------------------------------------------------------------	-----------------------------------------------------------------------------------------------------------------------------------------------------------------------------------	------------------------------------------------------------------------------------------------------

Light weight pump and motor, quick disconnection of the motor, start/stop switch with integrated overload protection, typical style of drum pumps	short overall length above the pressure outlet, less parts, long time service intervals	Quick separable motor, no spring balancer (lifting device) necessary, easy and safe handling of motor and pump, compliance with employment protection (weight)	Advantages like QCC, additional no tools needed for disassembly, quick disassembly, no specialist knowledge needed, safe in cleaning process, wetted components fit for washing machines, high flexibility	Advantages like QCC, certified for operation in hazardous locations
---------------------------------------------------------------------------------------------------------------------------------------------------	-----------------------------------------------------------------------------------------	----------------------------------------------------------------------------------------------------------------------------------------------------------------	------------------------------------------------------------------------------------------------------------------------------------------------------------------------------------------------------------	---------------------------------------------------------------------



Ideal for smaller quantities and higher pressure ranges than a centrifugal drum pump	If the pump is seldom moved, if spring balancer (lifting device) is available, for fixed installation in industrial equipment	Perfect for mobile applications in drums and containers, frequent lifting out of the drum, simple handling important for daily usage	Ideal version, if easy cleaning and simple disassembly are the main requirements in the application.	Obligatory for pumping highly combustible liquids, operation in hazardous locations
--------------------------------------------------------------------------------------	-------------------------------------------------------------------------------------------------------------------------------	--------------------------------------------------------------------------------------------------------------------------------------	------------------------------------------------------------------------------------------------------	-------------------------------------------------------------------------------------

652-... solid fixed in the drum hole with drum adapter stainless steel

650-, 651-, 653-, 654-... ready for the use with mounting bracket and overload protection switch (includes start/stop function, cable and plug), solid fixed in the drum hole with adapter stainless steel

Attention: use Ex-protection switch, equipotential cable

**Technical specifications of eccentric screw pumps ds**

Type		ds 8.1	ds 20.1	ds 40.1	ds 40.2	ds 80.1
capacity (max)	l/min	15	15	25	25	50
delivery head (max)	bar	4	6	6	10	6
viscosity (max)	mPas	5.000	100.000	100.000	100.000	80.000
materials (pump)		tube, drive shaft, rotor made of SS 1.4571				
tube length (L)	mm	1000   1200	1000	1000	1100	1100
tube diameter (D)	mm	40	54	54	54	54
discharge thread	OT	1 1/4"	1 1/2"	1 1/2"	1 1/2"	1 1/2"
weight	kg	4	8	8	8	8
max. temperature	NBR	80				
	PTFE	140				
materials (seal)	o-ring	FPM	FPM			
mechanical seal subject to rotation	MS	carbon, ceramic	HM/HM			
mechanical seal EX subject to rotation	MS	-	carbon/chrome-nickel			
stuffing box independent of the rotation	SB	-	PTFE-graphite			
stator materials		NBR light, PTFE				

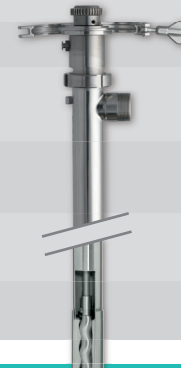

Typ		ds 8.1		ds 20.1		ds 40.1		ds 40.2		ds 80.1	
		MS		MS	SB	MS	SB	MS	SB	MS	SB
ord.-no 652-000X	L	1000	1200								
bayonet coupling	NBR	5	6	-	-	-	-	-	-	-	-
	PTFE	2	3	-	-	-	-	-	-	-	-
ord.-no rigid	NBR			650-0300	650-0304	650-0301	650-0305	650-0302	650-0306	650-0303	650-0307
	PTFE			0316	0320	0317	0321	0318	0322	0319	0323
ord.-no QCC	NBR			651-0001	651-0005	651-0002	651-0006	651-0003	651-0007	651-0004	651-0008
	PTFE			0009	0013	0010	0014	0011	0015	0012	0016
ord.-no SD	NBR			654-0001	654-0005	654-0002	654-0006	654-0003	654-0007	654-0004	654-0008
	PTFE			0009	0013	0010	0014	0011	0015	0012	0016
ord.-no Ex:	PTFE			653-0001	653-	653-0002	653-	653-0003	653-	653-0004	653-

Other type-sizes on demand, submersible length individual available, discharge thread on customers requests available

**1 Capacity - rotation**

Capacity depending on the rotation

1/min	l/min	l/min	l/min	l/min
2800	15			
1400	8			
900		15	25	50
700		9	19	39
500		6	14	27
300		4	8	16

**ds 8.1    ds 20.1    ds 40.1/40.2    ds 80.1**

**2 Viscosity - rotation - motor power**

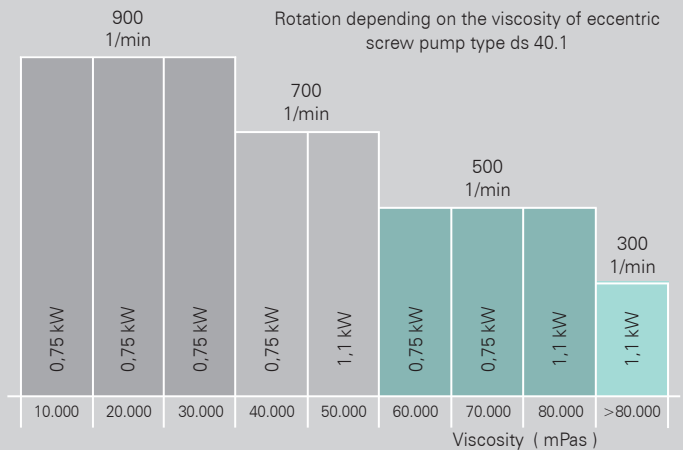

## Table for the motor choice



		gear-motor											
		300		500		700		900		1400		2800	
rotation (rpm)	power	ord.-no	kg	ord.-no	kg	ord.-no	kg	ord.-no	kg	ord.-no	kg	ord.-no	kg
motor type													
IP55, 50 Hz with terminal box	kW / V / phases												
bayonet										500-		500-	
on/off protection switch	0,37 / 230 / 1									0073	7	0042	7
without protection switch	0,37 / 230/400 / 3									0051	7	0039	7
ridgid		550-		550-		530-		530-					
	0,37 / 230/400	0041	14	0044	14	0101	13						
	0,55 / 230/400	0042	17	0045	17	0102	16	0106	14				
without protection switch	0,75 / 230/400	0043	18	0046	18	0103	20	0107	16				
	1,1 / 230/400					0104	23	0108	21				
	1,5 / 230/400					0105	25	0109	24				
QCC, SD		550-		550-		530-		530-					
	0,37 / 230/400	0017	14	0020	14	0036	13						
	0,55 / 230/400	0018	17	0021	17	0037	16	0047	14				
without protection switch	0,75 / 230/400	0019	18	0022	18	0038	20	0040	16				
	1,1 / 230/400					0039	23	0041	21				
	1,5 / 230/400					0088	25	0042	24				
Ex II 2 G Ex e II T3						530-		530-					
	0,65 / 230/400					0043	26	0051	14				
without protection switch	0,95 / 230/400					0044	31	0045	20				
	1,35 / 230/400					0095	28	0046	27				
QCC, compressed air								520-					
D4	0,6							0009	10				
D6	1,1							0010	14				

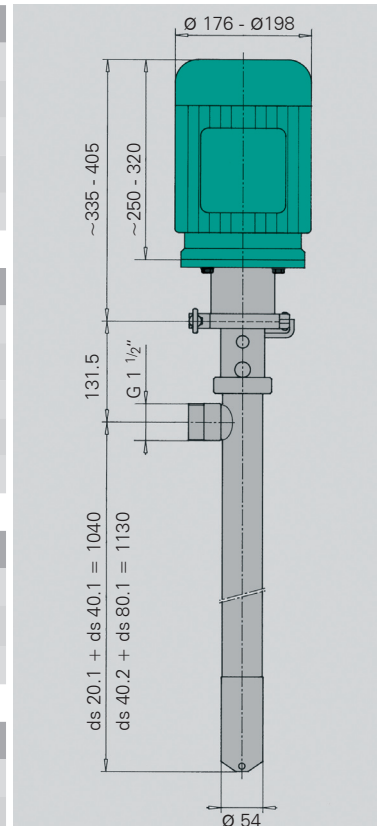
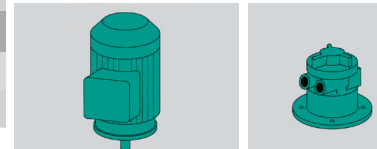

Single phase induction motor with on/off overload protection switch. The right combination for medium viscous fluids with all advantages of the bayonet coupling.

### Eccentric screw pumps in operation

The hydraulic performance of eccentric screw pumps can be influenced by the drive. The capacity variation is nearly proportional to the motor speed variation (s. table 1). Increasing viscosity reduces the flowability of the liquid. By reducing the motor speed the pump can be adjusted to the liquid (s. table 2). Low rotation prevents damage from highly viscous liquids. Theoretically the flow rate of the eccentric screw pump is independent of the discharge load. But in practise we see that depend-

ding on the discharge load. The leakage gap between rotor and stator grows with an increasing discharge load (s. table 3).

The characteristics in table 3 are measured with water. Increasing viscosity reduces the influence of the discharge load. For sizing the right pump you must consider the the relation of capacity and pressure load.

### 3 Pressure load - capacity

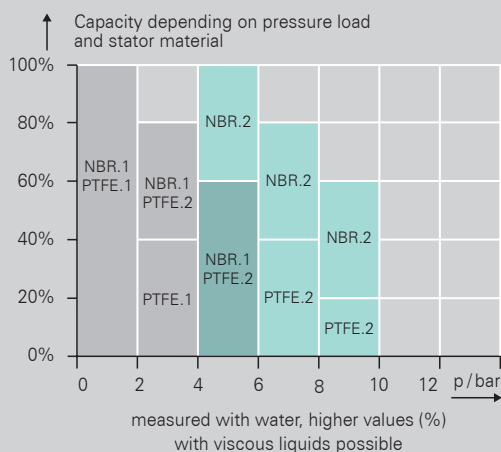

#### The way to the right motor drive

In table 2 you see the motors with power (kW) and rotation (rpm) related to the viscosity for the pump size 40.1. For the smaller type 20.1 you can choose a motor one power level lower. For the bigger types 40.2 and 80.1 you must choose a motor one power level higher.



# Important accessories for the eccentric screw pumps



Wall fastening for applications in suction mode outside of drums and containers

Hose connector with wing nut IT 1 1/2" ND 32 or ND 38



Drum adapter for solid fixing in the drum OT 2" d=52 mm



Tripod for applications outside of drums and containers with positive suctionhead

Foot strainer keeps particles away



Overload protection switch ready-for-use



More useful accessories see pricelist and on demand

Vertretung:

**grün-pumpen gmbh**  
**Otto-Schott Str. 19**  
**D-97877 Wertheim**  
 Telefon (09342) 9 35 16-0  
 Telefax (09342) 9 35 16-29  
 info@gruen-pumpen.de  
 www.gruen-pumpen.de

Commercial register  
 Reg. Court Mannheim  
 HRB 570326  
 Registered office:  
 Wertheim  
 Managing directors:  
 Ralph Dostmann,  
 Dr. Thomas Sigel  
 USt.IdNr. DE 160765854

**g**<sup>®</sup>  
**grün-pumpen**  
 take out, what's in.