



# 2023

CAR BODY  
WELDING SYSTEMS



French manufacturer since 1964

## 2 catalogues





Welding, Plasma cutting & Induction heating





Car Body Welding Systems

 With a strong reputation as an international brand, IMS offers you a comprehensive and innovative car body welding systems product range. Our mission is to provide both efficient and productive solutions to professionals. To that end, our products combine advanced technology, high quality and ergonomics for optimal user satisfaction. This catalogue introduces several new innovations and product improvements, we would like to thank our customers for their attention and their trust in the IMS brand.

 Fort de sa renommée mondiale, IMS est fier de vous proposer une gamme complète et innovante d'équipements dédiés à la carrosserie. Apporter des solutions efficaces et productives répondant aux exigences des professionnels est notre vocation. Nos produits associent technologie, qualité et ergonomie pour satisfaire pleinement nos utilisateurs. De nombreuses nouveautés et améliorations ponctuent ce catalogue. Par avance, nous vous remercions, cher client, pour votre attention et votre confiance.

 Het internationaal gerenommeerde merk IMS biedt u een compleet en innovend assortiment op het gebied van lastechniek aan. Onze passie: Het creëren van efficiënte en productieve oplossingen die beantwoorden aan de eisen van de professionele lasser. Alle IMS producten voldoen aan de hoogste kwaliteitseisen en combineren hoogwaardige technologie met de nieuwste ergonomische inzichten. In deze nieuwe IMS katalogus vindt u een scala aan vernieuwde en verbeterde producten. We danken u bij voorbaat voor uw aandacht, en voor het vertrouwen dat u in ons stelt.

 Die internationale Marke „IMS“, bietet Ihnen ein komplettes und innovatives Sortiment im Bereich Karosserie-Schweißtechnik. Mit IMS Artikeln erhalten Sie effiziente und leistungsfähige Produkte, die höchsten Anforderungen gerecht werden. Alle IMS-Produkte werden nach strengen Qualitätsrichtlinien entwickelt und produziert. Ergonomisch optimiert und langlebig konzipiert, erfüllen Sie so die hohen Ansprüche des professionellen Anwenders. Der neue IMS-Katalog enthält viele interessante Neuerungen. IMS – Innovative Möglichkeiten Sehen!

 Forte della Sua notorietà mondiale, IMS è orgogliosa di offrire una gamma completa e innovativa di attrezzature dedicate alla carrozzeria. Fornire soluzioni efficaci e produttive che soddisfino i requisiti professionali è la nostra vocazione. I nostri prodotti combinano tecnologia, qualità ed ergonomia per soddisfare appieno i nostri utenti. Molte nuove caratteristiche e miglioramenti caratterizzano questo catalogo. Vi ringraziamo anticipatamente, cari clienti, per la Vostra attenzione e la Vostra fiducia.

 Gracias a su prestigio mundial, IMS se enorgullece de presentarle una línea completa e innovadora de equipos especialmente dedicados a la carrocería. Nuestra misión es ofrecerle soluciones eficaces y productivas que cumplan con las exigencias de los profesionales. Nuestros productos combinan tecnología avanzada, calidad y ergonomía para satisfacer plenamente a nuestros usuarios. Numerosas novedades y mejoras completan este catálogo. Le agradecemos su atención y confianza.

## DENT PULLING

SPOT	6
SPOT PRO	7
SPOT ALU	8
COMBISPOT	9
ACCESSORIES & CONSUMABLES	10
SPOT ARCPULL	12
COMBISPOT ARCPULL	13
ACCESSORIES & CONSUMABLES	16
FAST EASY TOOLS	18
TROLLEYS	23
DENT PULLING WORKSTATIONS	23

## PULLING SYSTEMS

AIRFIX DRAW ALIGNER	31
DRAW ALIGNER	32
FRAME STRAIGHTENING	33

## PAINTLESS DENT REPAIR

POWERDUCTION AUTO DENT REPAIR	38
GLUE PULLING KITS	41

## MOBILE LIFTS

TROLLEY IW1	43
MULTITOOL TRUCK	43
SPOT LIFT	44
ERGOLIFT / QUICKLIFT	46
AIR JACKS / MANUAL WHEEL LIFT	47

## SPOT WELDING

TECHNOLOGY	50
SPOT INVERTER TRAF0	53
SPOT INVERTER TRAF0 PREMIUM PRO	55
SPOT INVERTER TRAF0 GENIUS	57
G ARMS	58
ACCESSORIES & CONSUMABLES	59

## RIVETING

GYS PRESS	62
GYS PRESS CONTROL	66
ADAPTERS	68
DIES BOXES & RIVETS	70
ACCESSORIES	73

## MIG WELDING

CARPRO	76
GOLD MULTI	77
MIG CARPRO	78
CARPULSE	80
TORCHES & CONSUMABLES	84
WELDING HELMETS	86

## INDUCTION HEATING

POWERDUCTION	94
ACCESSORIES & CONSUMABLES	100

## PLASMA

EASYCUT/CUTTER	104
----------------	-----

## ACCESSORIES

WINDSCREEN REPAIR	108
BUMPER REPAIR	110
HAND TOOLS	112
PNEUMATIC TOOLS	114
SANDING & DUST EXTRACTION	116
WORKING LIGHTS	118
WORKING SUPPORTS	120
SAFETY PROTECTION	122





# DENT PULLING

## STEEL / ACIER / STAHL

SPOT	6
SPOT PRO	7

## ALU

SPOT ALU	8
----------	---

## ALU + STEEL / ACIER / STAHL

COMBISPOT	9
ACCESSORIES & CONSUMABLES	10

## DRAWN ARC ALU + STEEL / ACIER / STAHL

SPOT ARCPULL	12
COMBISPOT ARCPULL	13
ACCESSORIES & CONSUMABLES	16

FAST EASY TOOLS	18
-----------------	----

TROLLEYS	23
----------	----

DENT PULLING WORKSTATIONS	23
---------------------------	----





SPOT

# DENT PULLING STEEL ACIER - STAHL

- Stars - Étoiles - Ausbeulstern
- Rings - Anneaux - Zugösen
- Wavy wires - Fils ondulés - Wellendraht
- Impact shrinking - Rabattage d'impact - Glätten

## OPTIONS

Consumables - Consommables p.8



Trolleys - Chariots p.23



- Stars - Étoiles - Ausbeulstern
- Rings - Anneaux - Zugösen
- Wavy wires - Fils ondulés - Wellendraht
- Impact shrinking - Rabattage d'impact - Glätten

- Tempering - Rétreinte - Temperieren



**FIXED GUN**

**FIXED GUN**

SPOT 2600

**2600 A** x1 **AUTOMATIC**

230V • 1~

021105

included



**Automatic quick gun**, 1.8 m, 70 mm<sup>2</sup>  
+ Hammer (057272)

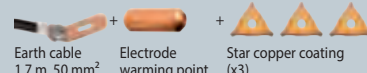

Earth cable 1.7 m, 50 mm<sup>2</sup>    Electrode warming point    Star copper coating (x3)

SPOT 2700

**2600 A** x1 **MANUAL**

230V • 1~

055360

included



**Manual quick gun**, 1.8 m, 70 mm<sup>2</sup> (058705)  
+ Hammer (057272)

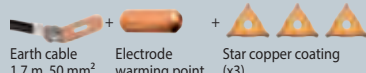

Earth cable 1.7 m, 50 mm<sup>2</sup>    Electrode warming point    Star copper coating (x3)

SPOT 3400

**3500 A** x1 **MANUAL**

230V • 1~

**SPOT 3400 - 230V**  
072930

400V • 2~

**SPOT 3400 - 400V**  
072947

included



**Manual quick gun**, 2 m, 50 mm<sup>2</sup>  
+ Hammer (057272)

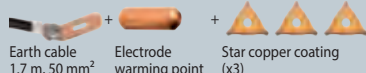

Earth cable 1.7 m, 50 mm<sup>2</sup>    Electrode warming point    Star copper coating (x3)

- Stars - Étoiles - Ausbeulstern
- Rings - Anneaux - Zugösen
- Wavy wires - Fils ondulés - Wellendraht
- Impact shrinking - Rabattage d'impact - Glätten
- Tempering - Rétreinte - Temperieren
- Rivets - Rivets - Nieten
- Rings - Rondelles - Unterlegscheiben
- Studs - Goujons - Gewindebolzen

SYNERGIC CONTROL

PATENTS REGISTERED NUMBERS  
EUROPEAN TRADEMARK & DESIGN



EXPERT SYNERGIC & MANUAL CONTROL

Welding current adjustment

Welding time adjustment



**GUN WITH CONNECTOR**

SPOT 3900

**3800 A** x1 **AUTOMATIC**

230V • 1~

**SPOT 3900 - 230V**  
019355

400V • 2~

**SPOT 3900 - 400V**  
019362

included



**Automatic quick gun**, 2 m, 70 mm<sup>2</sup> (057517)  
+ Hammer (057272)

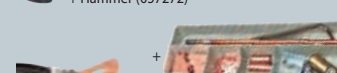

Earth cable 2 m, 70 mm<sup>2</sup>

**SPOTTER BOX STANDARD** (053915)  
(Details p.8)

SPOT PRO 230 & PRO 400

**3800 A** x2 **AUTOMATIC**

230V • 1~

**SPOT PRO 230**  
022287

400V • 2~

**SPOT PRO 400**  
021754

included



**Automatic quick gun**, 3 m, 50 mm<sup>2</sup> (057500)  
+ Hammer (057272)

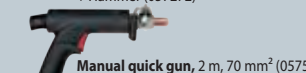

**Manual quick gun**, 2 m, 70 mm<sup>2</sup> (057524)

Earth cable 2 m, 70 mm<sup>2</sup>

**SPOTTER BOX PRO** (050075)  
(Details p.8)

SPOT EXPERT 230 & 400

**3800-4500 A** x2 **AUTOMATIC**

230V • 1~

**SPOT EXPERT 230**  
066892

400V • 2~

**SPOT EXPERT 400**  
058941

included



**Automatic quick gun**, 3 m, 70 mm<sup>2</sup> (059207)  
+ Hammer (057272)



**Manual quick gun**, 2 m, 70 mm<sup>2</sup> (057524)

Earth cable Thick 3 mm 2 m, 70 mm<sup>2</sup>

**SPOTTER BOX PRO** (050075)  
(Details p.8)

## QUICK GUNS

**Quick & Easy**

**AUTOMATIC**



**WITH CONNECTOR**  
3 m, Ø 70 mm<sup>2</sup>  
included PRO 230/400  
057517



**WITH CONNECTOR**  
3 m, Ø 50 mm<sup>2</sup>  
included PRO 230/400  
057500

**WITH CONNECTOR**  
3 m, Ø 70 mm<sup>2</sup>  
included EXPERT 230/400  
059207

**MANUAL**



**WITH CONNECTOR**  
cable 2 m, Ø 70 mm<sup>2</sup>  
included PRO 230/400,  
EXPERT 230/400,  
COMBISPOT 230  
057524

**No connector**  
cable 1.8 m, Ø 70 mm<sup>2</sup>  
for 2700  
058705

**No connector**  
cable 2 m, Ø 50 mm<sup>2</sup>  
for 3400 - 230V / 3400 - 400V

PATENTS REGISTERED NUMBERS  
001830845-0001  
EUROPEAN TRADEMARK & DESIGN

	CE NORM. 62135	50/60 Hz	I <sub>2</sub> max A	U <sub>2</sub> V	I <sub>AM</sub> A	I <sub>RMS</sub> A	kW	OK	OK	MANUAL	SYNERGIC	AUTOMATIC	MANUAL	SEPARATE CABLE GUN	cm	kg
MADE IN CHINA	SPOT 2600	230V	2 m	2600	5,4	16	1800	10	OK	—	—	—	—	—	20 x 32 x 18	15
	SPOT 2700	230V	2 m	2600	5,4	16	1800	10	OK	—	—	—	—	—	20 x 32 x 18	14.5
	SPOT 3400 - 230V	230V	2 m	3500	7,4	16	2500	20	OK	OK	—	—	—	—	22,5 x 36 x 23,5	21
	SPOT 3400 - 400V	400V, 2ph	4 m	3500	7,4	16	2500	20	OK	OK	—	—	—	—	22,5 x 36 x 23,5	21
MADE IN FRANCE	SPOT 3900 - 230V	230V	4 m	3800	7,4	16	2800	20	OK	OK	—	—	—	—	22,5 x 36 x 23,5	22
	SPOT 3900 - 400V	400V, 2ph	4 m	3800	7,4	16	2800	20	OK	OK	—	—	—	—	22,5 x 36 x 23,5	22
	SPOT PRO 230	230V	8 m	3800	7,4	16	2800	20	OK	OK	—	—	—	—	22,5 x 36 x 23,5	20.5
	SPOT PRO 400	400V, 2ph	8 m	3800	7,4	16	2800	20	OK	OK	—	—	—	—	22,5 x 36 x 23,5	20.5
	SPOT EXPERT 230	230V	8 m	3800	7,4	16	2800	20	OK	OK	—	—	—	—	22,5 x 36 x 23,5	20.5
	SPOT EXPERT 400	400V, 2ph	8 m	4500	7,4	16(D)	3200	25	OK	OK	—	—	—	—	22,5 x 36 x 23,5	22.5





SPOT ALU

# DENT PULLING ALU

FV FLEXIBLE VOLTAGE

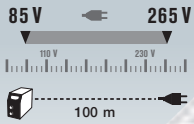

**FIXED GUN**

SYNERGIC CONTROL

PATENTS REGISTERED NUMBERS  
EUROPEAN TRADEMARK & DESIGN



Studs - Goujons



- Stars - Étoiles
- Rings - Anneaux
- Wavy wires - Fils ondulés
- Impact shrinking - Rabattage d'impact
- Tempering - Rétreinte
- Rivets - Rivets
- Rings - Rondelles
- Studs - Goujons

SPOT ALU FV

100 · 230V · 1~

**7500 A** x1 **AUTOMATIC**

FV

020689

included for Ø 4 mm



Automatic alu gun  
3 m, 25 mm<sup>2</sup>



ALU BOX STANDARD (050020)  
(Details p.9)

ALU GUN

**AUTOMATIC**

3 m, Ø 25 mm<sup>2</sup>

included SPOT ALU FV  
& COMBISPOT 230

(x 3)  
065635

**66 mF** CAPACITOR  
DISCHARGE WELDING

Ø 4mm

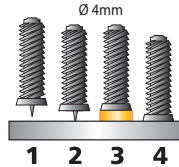

Joint rings for  
mandrel Ø 4/5/6  
x 2  
060814

PATENTS REGISTERED NUMBERS  
002446450-0001  
EUROPEAN TRADEMARK & DESIGN

OPTIONS

Consumables - Consommables  
p.11



ALU accessories - Accessoires ALU  
p.19



Trolleys - Chariots  
p.23



COMBISPOT

# DENT PULLING ALU + STEEL ACIER - STAHL

**2 GUNS  
INCLUDED**



**GUN WITH CONNECTOR**

COMBISPOT 230

230V · 1~

**3800 A** Steel / Acier / Stahl

**7500 A** Alu

x2

AUTOMATIC

MANUAL

AUTOMATIC

020580

included

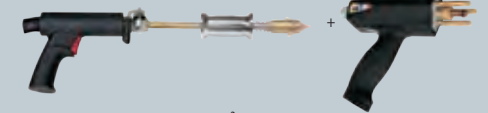

Manual quick gun, 2 m, 70 mm<sup>2</sup> (057524)  
+ Hammer (057272)

Automatic alu gun, 3 m, 25 mm<sup>2</sup>

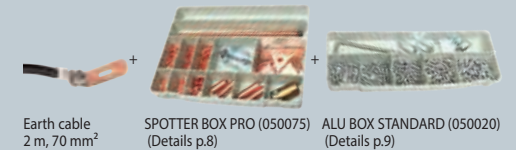

Earth cable  
2 m, 70 mm<sup>2</sup>

SPOTTER BOX PRO (050075)  
(Details p.8)

ALU BOX STANDARD (050020)  
(Details p.9)

	MADE IN FRANCE 62135	50/60 Hz		I <sub>2</sub> max A	U <sub>2</sub> V	I <sub>AM</sub> A	I <sub>RMS</sub> A	kW			MANUAL	SYNERGIC			AUTOMATIC	MANUAL	SEPARATE CABLE GUN			cm	kg
SPOT ALU FV				7500	50 ,200	5	—	0.65	OK	OK	■	■	—	■	x1	—	—	3 m	Included Alu box	21 x 24 x 36	12.5
COMBISPOT 230				3800 (steel) 7500 (alu)	7,4 (steel) 50, 200 (alu)	16	2800 (steel)	20	OK	OK	—	■	■	■	x1	x1	■	2/3 m	Included Spotter box + Alu box	45 x 43 x 29	42.5

ims  
PRO

9

SPOT

ALU + STEEL DENT PULLING





# SPOT ACCESSORIES & CONSUMABLES

## ACIER / STEEL / STAHL



DENT BOX CONSUMABLES / BAR SPOTTER BOX STANDARD / 2600 / 2700

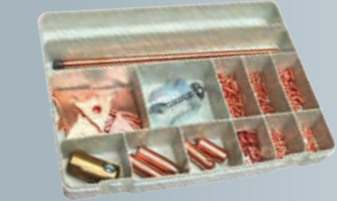

SPOTTER BOX PRO

### DENT BOX

**CONSUMABLES**  
051515

**BAR**  
050037



### SPOTTER BOX

**PRO**  
050075



**STANDARD**  
053915

**2600**  
052277



**2700**  
053922



hexagon Earth plate small	chuck for inertia hammer copper coating star	electrode ø 8 x 16 earth hook	carbon heating electrode	electrode warming point ø 16 Ball electrode warming point ø 16 M8
x1	x20	x1	x5	x1
049482	052239	049574	049468	049789
				049727
				049772

electrode straight rings twisted rings lifting rod	electrode for threaded studs rivets ø 5 - M5, M6 threaded M5 x 18 x 0.8 self-threading ø 5 x 18 ø 5 x 12	electrode ø 16, 3 x 4,50 ø 3 x 3,25 ø 3 x 4,50	electrode ø 2 - M4 ø 2	electrode wheel ø 16	x1	x1	x1	x1
x1	x100	x1	x1	x1	x1	x1	x1	x1
050655	050648	049598	049277	050310	049673	052529	049666	051997
050631	050631	049413	041561					

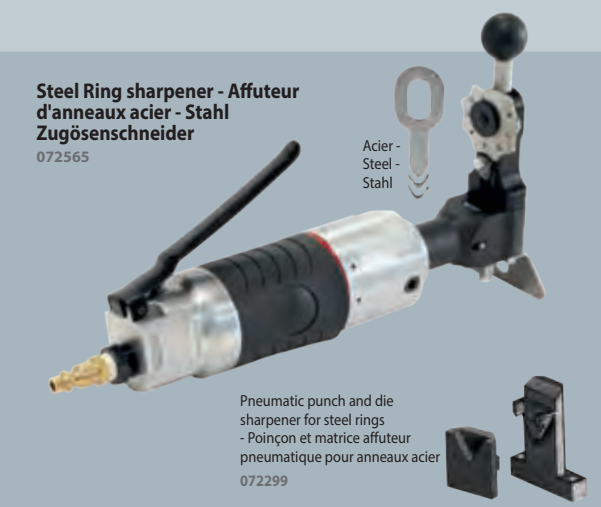
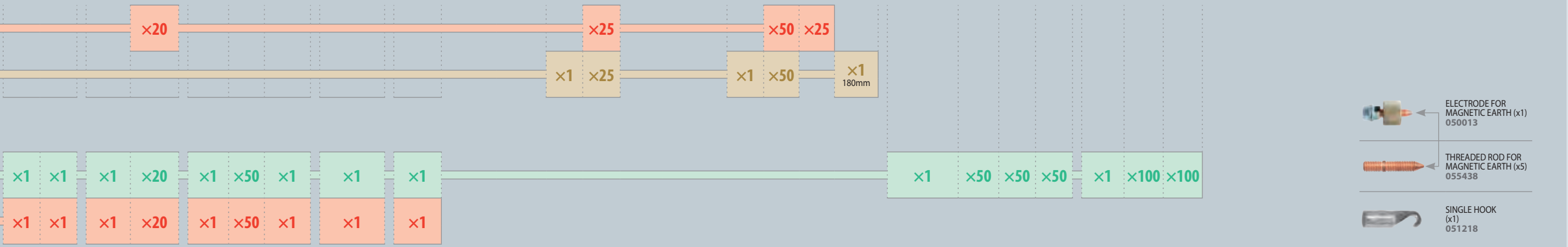

Steel Ring sharpener - Affuteur d'anneaux acier - Stahl Zugöschneider  
072565

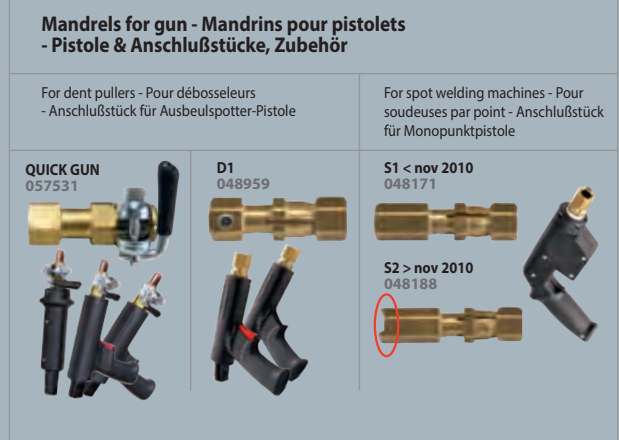

Mandrels for gun - Mandrins pour pistolets - Pistole & Anschlußstücke, Zubehör



QUICK GUN 057531, D1 048959, S1 < nov 2010 048171, S2 > nov 2010 048188



## ALU

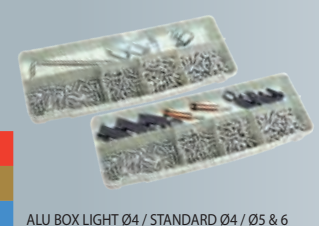

### ALU BOX

**LIGHT Ø 4**  
051522

**STANDARD Ø 4**  
050020

**Ø 5 & 6**  
048195

ø 4 x2 ø 5 x1 ø 6 x1	ø 4 - M4 x200 ø 4 - M4 x1000 ø 5 x100 ø 6 x100	ø 4 - M4 x200 ø 4 - M4 x1000 ø 5 x100 ø 6 x100	ø 4 x5 ø 5 x5	ø 4 x5 ø 5 x5	x3 : 180, 300, 500 mm ø 50792
049000	048157	048164	050297	058712	050792

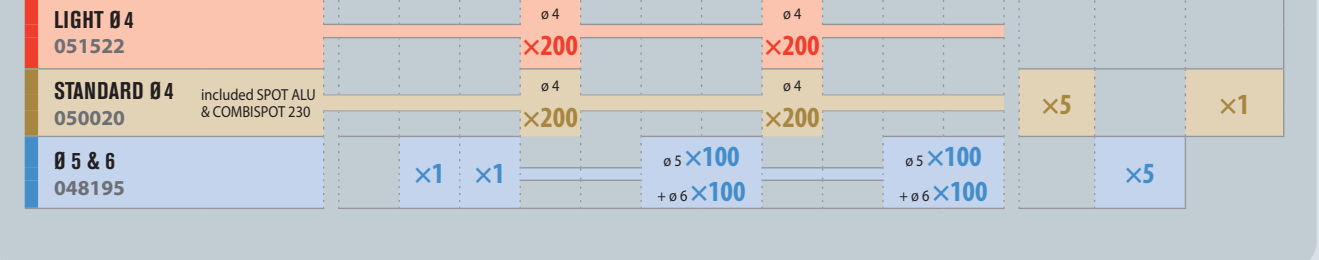

Pneumatic punch and die sharpener for steel rings - Poinçon et matrice affuteur pneumatique pour anneaux acier  
072299





SPOT ARCPULL

# DENT PULLING DRAWN ARC ALU + STEEL

ACIER - STAHL



MANUAL

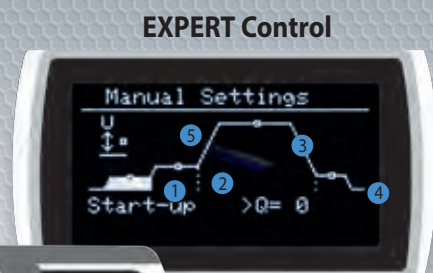

EXPERT Control

- Rings - Anneaux - Zugösen
- Studs - Goujons - Gewindebolzen
- Stainless steel nails - Tiges inox - Edelstahlnägel



- Start-up - Amorce - Zündung
- Scouring (I & t) - Décapage - Abbeizen
- Arc (I & t) - Arc - Lichtbogen
- Hitching (I & t) - Accroche - Verklebung
- Height - Hauteur - Höhe

7 languages  
FR, EN, DE, SP, IT,  
NL & RU

## SYNERGIC DIGITAL GUNS

★★★★★  
**UNIQUE  
Linear Motor**

**DRAWN ARC PROCESS**  
Gas protection

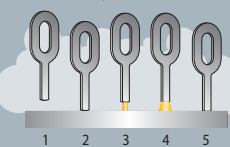

3 m, Ø 25 mm<sup>2</sup>

included  
ARCPULL  
200, 350 &  
COMBISPOT  
ARCPULL



Full control



Consumables for Gun



FV FLEXIBLE  
VOLTAGE

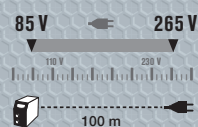

SR SECONDARY  
REGULATION



AD ANTI-DUST



MANUAL &  
SYNERGIC CONTROL

2 GUNS  
INCLUDED



Ø max  
Alu : 6 mm  
Fe : 6 mm



GUN WITH CONNECTOR

SPOT ARCPULL 200

100 · 230V · 1~

200 A **T** x1 MANUAL

FV SR AD

059405

included



Manual synergic gun  
3 m, 25 mm<sup>2</sup>  
x1  
ALU RING BOX 1.5 mm  
(AlSpec + AlMg3 + AlMgSi)  
059429  
+ Lifting rod 180 mm  
(x3)

OPTIONS

details p.23

Weld 810  
for ARCPULL 200  
037489



COMBISPOT ARCPULL

230V · 1~

ARCPULL

200 A

Alu

**T** x1

MANUAL

EXPERT

3800 A

Steel / Acier / Stahl

**T** x1

MANUAL AUTOMATIC

075627

Arcpull accessories included



Manual synergic gun  
3 m, 25 mm<sup>2</sup>  
x1  
ALU RING BOX 1.5 mm  
(AlSpec + AlMg3 + AlMgSi)  
059429  
+ Lifting rod 180 mm  
(x3)

Expert accessories included



Manual quick gun, 2 m, 70 mm<sup>2</sup> (057524)

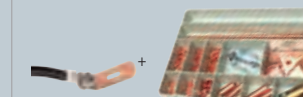

Earth cable  
2 m, 70 mm<sup>2</sup>

SPOTTER BOX PRO (050075)  
(Details p.10)

MADE IN FRANCE 60974-1	50/60 Hz	I <sub>2</sub> A	SYNERGIC			MANUAL		IRMS (A)	Steel / Acier		U <sub>2</sub> V	+AM- A	kW	OK	OK	cm	Product	Product + gun
			SYNERGIC	MANUAL	IRMS (A)	Manual	Alu											
SPOT ARCPULL 200	110 · 230V	6 m	10 · 100 (110 V) 10 · 200 (230 V)	■	■	—	Manual + Digital Gun Motion Control	20.4 · 24 V (110 V) 20.4 · 28 V (230 V)	16	2.4 (110 V) 5.6 (230 V)	OK	OK	20.5 x 25 x 33	8.6 kg	11.9 kg			
COMBISPOT ARCPULL	230V	8 m	Alu 10 · 200 Acier 3800	■	■	Steel 3800	Manual Automatic (not included)	Manual Alu 20.4 · 28 V Steel 7.4 V	16	Alu 5.6 Steel 20	OK	OK	45 x 37 x 24.5	29 kg	39 kg			





SPOT ARCPULL

# DENT PULLING DRAWN ARC ALU + STEEL ACIER - STAHL



- Rings - Anneaux - Zugösen
- Start-up - Amorce - Zündung
- Hitching (I & t)
- Studs - Goujons - Gewindebolzen
- Scouring (I & t) - Décapage
- Accroche - Verklebung
- Stainless steel nails - Tiges inox
- Abbelzen
- Height - Hauteur
- Edelstahlnägel
- Arc (I & t) - Arc - Lichtbogen
- Hohe

MANUAL



7 languages  
FR, EN, DE, SP, IT,  
NL & RU

## SPECIAL TEARING RIVETS

Spécial arrachage de rivets - Spezial-Zugnieten

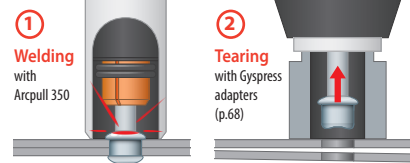

∅ max  
Alu/Fe: 8 mm

PFC POWER FACTOR CORRECTION

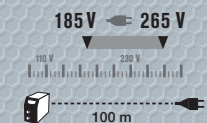

SR SECONDARY REGULATION

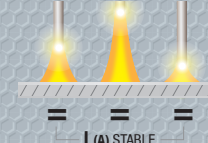

AD ANTI-DUST

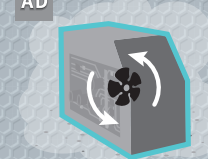

∅ max  
Alu: 10 mm  
Fe: 13 mm



3 m, ∅ 50 mm<sup>2</sup>  
included  
ARC PULL 700



Ideal  
all position

## SYNERGIC DIGITAL GUNS

★★★★★  
DRAWN ARC PROCESS  
Gas protection  
UNIQUE  
Linear  
Motor

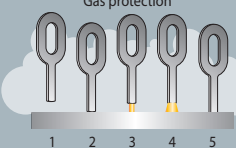

FULL CONTROL

3 m, ∅ 25 mm<sup>2</sup>

included  
ARCPULL  
200, 350 &  
COMBISPOT  
ARCPULL



Consumables for Gun



### SPOT ARCPULL 350

208 · 240V · 1~

350 A x1 MANUAL

PFC SR AD

066762

included



Manual synergic gun  
3 m, 25 mm<sup>2</sup>

### OPTIONS

details p.23

Weld 810  
for ARCPULL 350  
037489



### PACKS ARCPULL 350

350 RIVET  
071728

350 PULLER  
071735

350 PULLER + RIVET  
071742

	Arcpull 350	Croco T400.70	Rivet box	Alu ring box 1.5 mm	Lifting rods
043787	064584	059429	059610	050792	
	■	■	■	■	■
	■	■	■	■	x1
	■	■	■	■	x1

### SPOT ARCPULL 700

380 · 480V · 3~

680 A x1 MANUAL

SR IP 23

072855

included

Manual synergic gun  
3 m, 50 mm<sup>2</sup>

Arc Pull Rivet Box 700

Lifting rod 180 mm (x1)

Ground studs holder  
∅ 6 (x1)  
075368  
∅ 8 (x1)  
075375  
∅ 10 (x1)  
075382

Threaded holder  
∅ 5 (x1)  
076174  
∅ 6 (x1)  
068391

Double earth clamps  
700 A, 3 m, 50 mm<sup>2</sup>  
068605

ALU RING BOX  
1.5 mm  
(AlSpec + AlMg3 + AlMgSi)  
059429

Gas protection (x1)  
068346

### OPTIONS

details p.23

Weld 910  
for ARCPULL 700  
070967



MADE IN FRANCE 60974-1	50/60 Hz	I <sub>2</sub> A	SYNERGIC	TECHNOLOGY	U <sub>2</sub> V	kW	cm	ArcPull	ArcPull + gun			
										Steel / Acier	Alu	Power Factor Correction
SPOT ARCPULL 350	208 · 240V	6 m	10 · 350	Manual + Digital Gun Motion Control	20.4 · 34V	16	11.9	OK	OK	30 x 24.5 x 22	11 kg	14.3 kg
SPOT ARCPULL 700	3x 400V 3x 480V	5 m	50 · 680	Manual + Digital Gun Motion Control	22 · 44V	20 A (D) 16 A (D)	47.8 kW 45.7 kW	OK	OK	32 x 32.4 x 41	17.4 kg	20.4 kg





# SPOT ARCPULL 200 & 350 ACCESSORIES & CONSUMABLES

## STEEL / ACIER / STAHL

	x1 059634	x1 059641	x1 064065	x100 041561	x100 064034	x2 049000	x100 059603	x100 064607	x1 048157	x100 049383	x100 049413	x100 049420	x1 048164	x100 063969	x200 063990	x1 064041	x200 064003	x1 064058	x100 063976
<b>STEEL STUDS BOX 350</b> 059443	x1	x1				x1	x100		x1	x100	x100	x100							

## ALU

	x1 059634	x1 059641	x2 049000	x100 059573	x1 048157	x100 059580	x1 048164	x100 059597	x200 064010	x1 064041	x200 064027	x1 064058	x100 063983
<b>ALU STUDS BOX 350</b> 059436	x1	x1	x1	x100	x1	x100	x1	x100					

	straight rings						twisted rings						
	Al-Special		AlMg3		AlMgSi		Al-Special		AlMg3 - x 50		AlMgSi - x 50		
box	n°1 1mm x100	n°4 1.5mm x100	n°8 2mm x100	n°2 1mm x100	n°5 1.5mm x100	n°3 1mm x100	n°6 1.5mm x100	n°1 1mm x50	n°4 1.5mm x50	n°2 1mm x50	n°5 1.5mm x50	n°3 1mm x50	n°6 1.5mm x50
	059535	059559	065703	059498	059511	059450	059474	059542	059566	059504	059528	059467	059481
box	<b>ALU RING BOX 1 mm</b> 059412												
	1mm x50		1mm x50		1mm x50		1mm x20		1mm x20		1mm x20		
box	<b>ALU RING BOX 1.5 mm</b> 059429												
	1.5mm x50		1.5mm x50		1.5mm x50		1.5mm x20		1.5mm x20		1.5mm x20		
sachet - bag	<b>ALU RING BOX 2 mm</b> 065703												
	2mm x100												

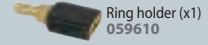

## SPOT ARCPULL 700 - ACCESSORIES & CONSUMABLES

x100 070745	x1 070738	x1 066151	x1 071377	x1 059641	x1 059610	x1 071384	x1	x1 068346	x1 075368	x1 075375	x1 075382
<b>ARCPULL RIVET BOX 700</b> 068452	x100	x1	x1	x1	x2	x1	x1	x1	x1	x1	x1

<b>STUDS HOLDER BOX 350</b> 064591		x1	x1	x1	x1	x1	x1	x1	x1							x1
<b>ARCPULL DIFFICULT ACCESS BOX 350</b> 070813		x1	x1									x1	x1	x1	x1	x1







# FAST DENT PULLING

## STEEL / ACIER / STAHL

### EASY TOOL CONNECTION



for SPOT 3900 - 230V/400V, PRO 230/400, EXPERT 230/400, COMBISLOT 230

051690

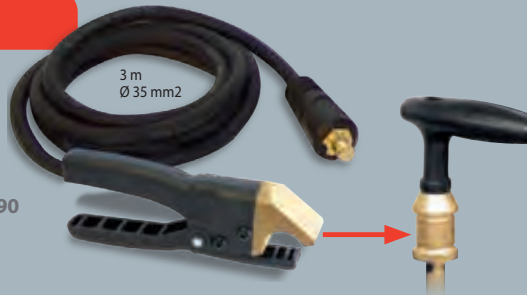

3 m  
Ø 35 mm<sup>2</sup>

### MANLINER/GUN 056831



Pads - Patins (x2) 060807



Gun adapter - Adaptateur pistolet included 052499

PATENTS REGISTERED NUMBERS 001652108-0003 EUROPEAN TRADEMARK & DESIGN

Direct impact electrodes (x5) 050839

051584 380 g 	051652 	051669 	051676 	EASYGUN 051317 	Box of 3 electrodes for accessories 050822 	Manual dent-pulling bar - Poignée de tirage manuel 057289 
Rings - Anneaux - Anschweißösen		Wavy wires - Fils ondulés - Wellendraht	Tempering - Rétreinte - Glättwerkzeug			

### MANUSPOT = 050679



Tools set & support for DENT 600, 800, 1000, 1600, Workstation & Dentstation



### MANLINER 050471



PATENTS REGISTERED NUMBERS 001652108-0003 EUROPEAN TRADEMARK & DESIGN

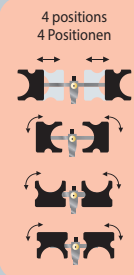

4 positions  
4 Positionen

### MANU PULLER 079502

NEW



Included Alu 3 065178

Included 079830

Included Alu 4 065185

## ALU

### ARCPULLER PREMIUM 065161



Included Alu 3 065178

Included Alu 4 065185

Pads - Patins (x2) 069008

ULTRA RESISTANT No deformation

GRIP Full rotation

Multi positions

### ARCPULLER PREMIUM PRO 072572



Pads - Patins (x4) 074958

Included Alu 3 065178

Included Alu 4 065185

### ALU PULLER 051003

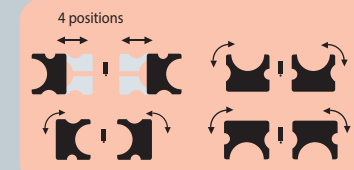

4 positions

Included Alu 1 050938

Included Alu 2 050945

Pads - Patins (x2) 060807

### STRAIGHT LINE LAMP 056770

- Lampe ligne droite - Dentline-laser



### FAST PULLING RINGS 058743

- Anneaux de tirage rapide



x5 058712

Alu 1 050938

Alu 2 050945

alu screws - goujons alu ø 4, 5 & 6 mm

### ALU HAMMERS 020986

- Marteaux alu



Marteau à inertie 380 g 050051

### FAST & EASY



### RINGMATIC 052154

included (x 50)



Option Gun adapter - Adaptateur pistolet 052499

### STEEL RING SHARPENER - Affuteur d'anneaux acier - Stahl Zugönschneider 072565



Steel - Acier - Stahl

Pneumatic punch and die sharpener for steel rings - Poinçon et matrice affuteur pneumatique pour anneaux acier 072299

### QUICK SPOT AIR GUN V2 057340

LIGHT 920 g



2,5 m

### QUICK SPOT AIR GUN V2 + Mini-fraiseuse - Mini-Druckluftfräser 065567

057340 + 063228



Included Tungsten drill Ø 6 mm 054172

Gun adapter - Adaptateur pistolet 052826

Heat gun - Décapeur thermique - Heißluftpistole

I: 100/300°C (450 W)  
II: 300/650°C (1500 W)  
Air flow: 450 l/min



066311

Gas hot air gun - Pistolet à air chaud autonome à gaz

Gas cylinder included - Bouteille de gaz incluse



060777

Blow torch - Lampe à souder - Lötlampe

NOVACET



052741

Novacet + (Butane/propane/propylene) 380 ml/220 g

HIGH QUALITY



040441

Brushes - Brosses - Bürsten - Brosses - Cepillos

Stainless - Inox - Edelstahl



044258

Thermal marking pencil - Crayon marqueur thermique

121°C / 250°F



052765

Infrared Thermometer - Thermomètre infrarouge

-50 / +380°C / -58 / +716°F



052994

Freezer spray - Spray refroidisseur

-50°C 400 ml

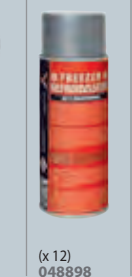

(x 12) 048898

Heat barrier spray - Spray barrière thermique

054325



054325



**SLIDE HAMMERS** - Marteaux inertie - Ausbeulhammer

**COMPLETE 057272**

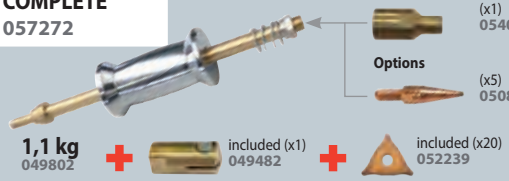

(x1) 054028  
Options  
(x5) 050839

**1,1 kg**  
049802

included (x1) 049482  
included (x20) 052239

Nails - Clous - Nägel



**1,1 kg**  
041813

MIG/MAG nozzle for Nail welding 041523  
Ø2 (x100) 041561  
Ø 2, M4 (x1) 049277

Washers - Rondelles - Ringe



**1,7 kg**  
051201

51 cm

8x16 (x100) 049444  
Ø 16, 8x16 (x1) 049574  
(x1) 051218

**COMPLETE KIT 051225**

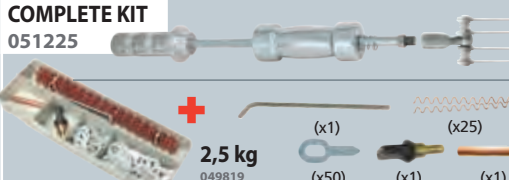

**2,5 kg**  
049819

(x1) (x25)  
(x50) (x1) (x1)

Slide hammer kit - Kit marteau à inertie - Ausbeulhammerset



**6 kg**  
051928

Pulling handle 3 claws - Poignée de tirage 3 dents - Handzugkralle 3-fach



057326

Pulling handle 2 claws - Poignée de tirage 2 dents



057319

Alu Puller 051003



Mini Puller 050921

Alu 1 050938  
Alu 2 050945

**GRIPPING HOOK HEAD** - Griffes - Ausbeulhaken

Compatibility:

STANDARD	PREMIUM

2-teeth hook 057296  
Premium 2-teeth hook 059382  
Premium 3-teeth hook 059658

Curved lifting rod 280 mm 064706

Lifting rods 180, 300 & 500 mm 050792

**STANDARD**

Levelling lever - Levier de débousselage - Zughebel  
1.6 kg  
**050686**

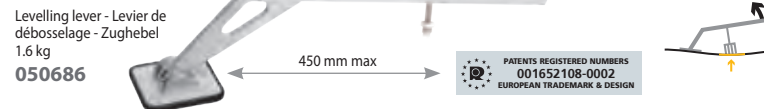

450 mm max

PATENTS REGISTERED NUMBERS 001652108-0002  
EUROPEAN TRADEMARK & DESIGN

Double action levelling bar - Barre de débousselage double action - Zughebelbrücke  
**053564**

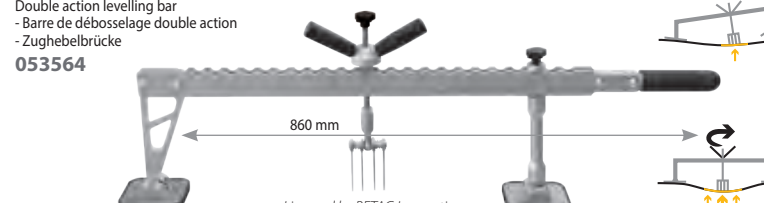

860 mm

Licensed by BETAG.Innovation

Levelling bar - Barre de débousselage - Zugbrücke  
3.4 kg  
**050693**

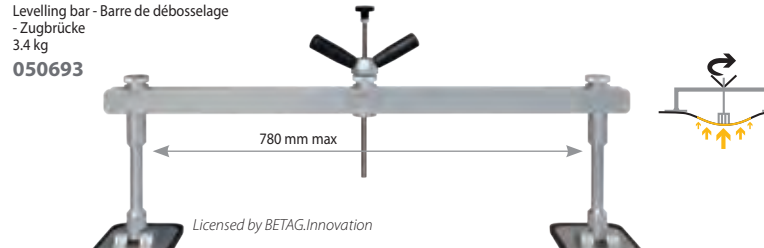

780 mm max

Licensed by BETAG.Innovation

Reinforced scissoring bar - Barre de tirage renforcée - Scherenzugbrücke  
5.1 kg  
**050716**

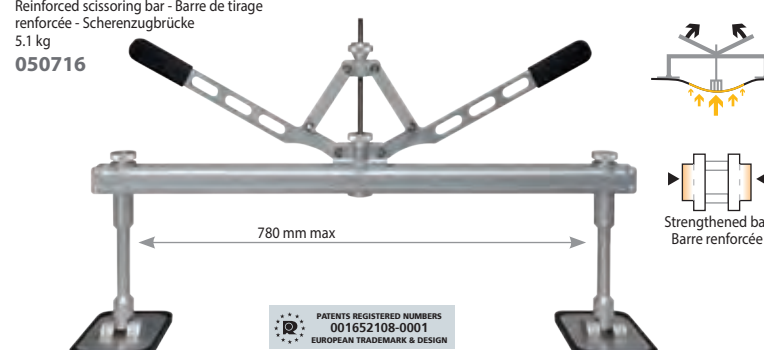

780 mm max

Strengthened bar Barre renforcée

PATENTS REGISTERED NUMBERS 001652108-0001  
EUROPEAN TRADEMARK & DESIGN

**OPTIONS**

Strengthened bar - Barre renforcée - 1200 mm 051171

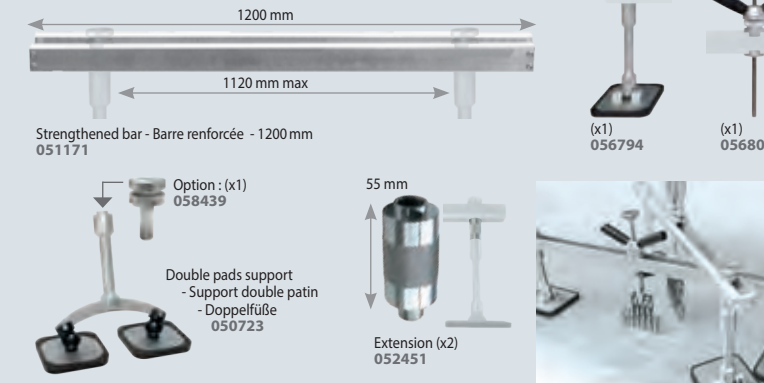

1200 mm  
1120 mm max

(x1) 056794 (x1) 056800

Option : (x1) 058439

55 mm

Double pads support - Support double patin - Doppelfüße 050723

Extension (x2) 052451

**PREMIUM**

ULTRA LIGHT

ULTRA ERGONOMIC

ULTRA RESISTANT  
No deformation

PERFECT BALANCE

jms PRO

Premium levelling lever - Levier de débousselage Premium - Premium Zughebel  
1.6 kg  
**059290**

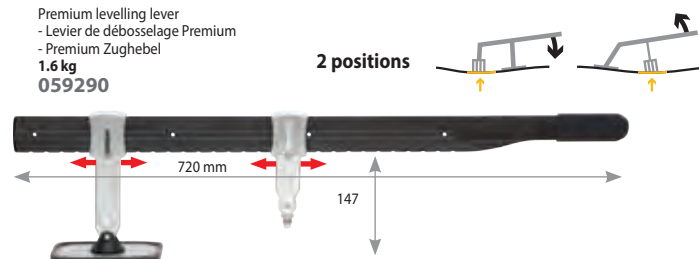

2 positions

720 mm  
147

Premium levelling bar - Barre de débousselage Premium - Premium Zugbrücke  
2.8 kg  
**059306**

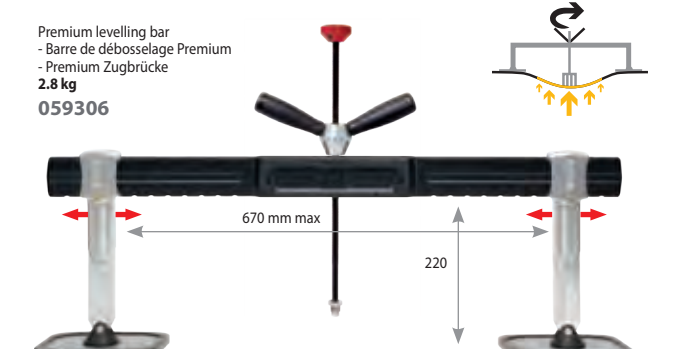

670 mm max  
220

Premium scissoring bar - Barre de tirage Premium - Premium Scherenzugbrücke  
3.1 kg  
**058996**

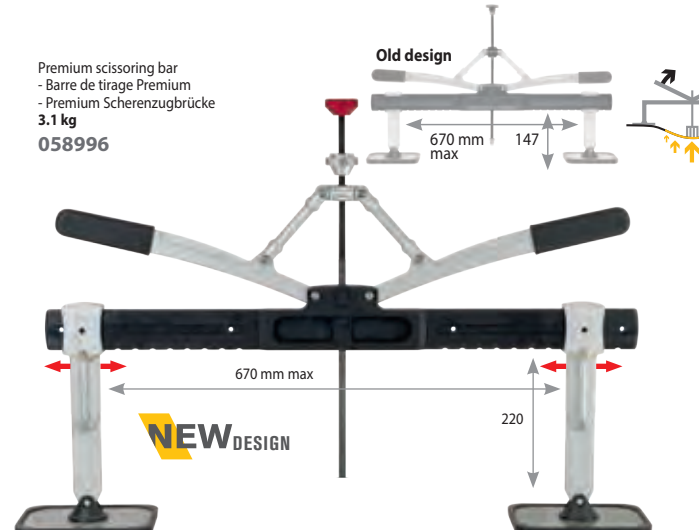

Old design  
670 mm max  
147

**NEW DESIGN**

670 mm max  
220

Premium 1200 scissoring bar - Barre de tirage 1200 renforcée Premium - Premium Scherenzugbrücke 1200  
5.6 kg  
**059313**

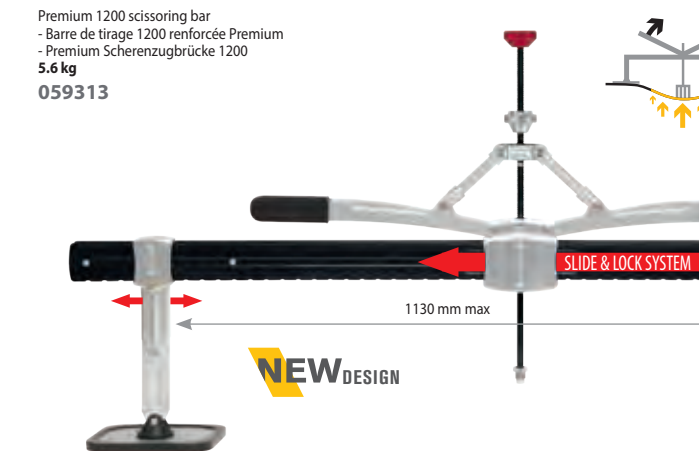

Old design  
1130 mm max  
220

**NEW DESIGN**

1130 mm max  
220

SLIDE & LOCK SYSTEM

Strengthened bar Barre renforcée

SLIDE & LOCK

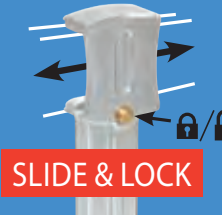

GRIP



FULL ROTATION

Multi positions



Arcpuller Premium 065161

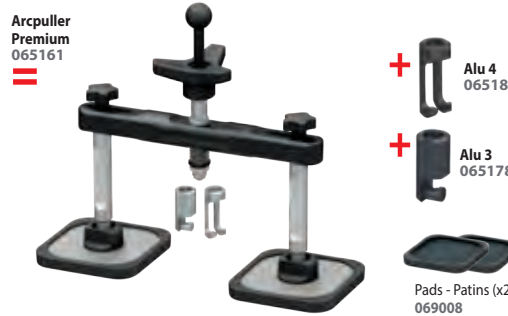

Alu 4 065185  
Alu 3 065178  
Pads - Patins (x2) 069008

x2 059375  
x2 059351  
150  
270  
x1 072688



x1 059320  
150  
x2 061293  
220



069268  
059399

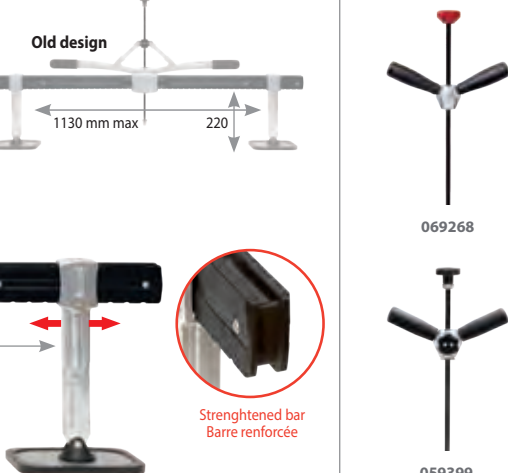



# PREMIUM PRO

Premium Pro levelling bar 900 mm  
- Barre de débosselage Premium Pro 900 mm  
- Premium Pro Zugbrücke 900 mm  
3.8 kg  
071643

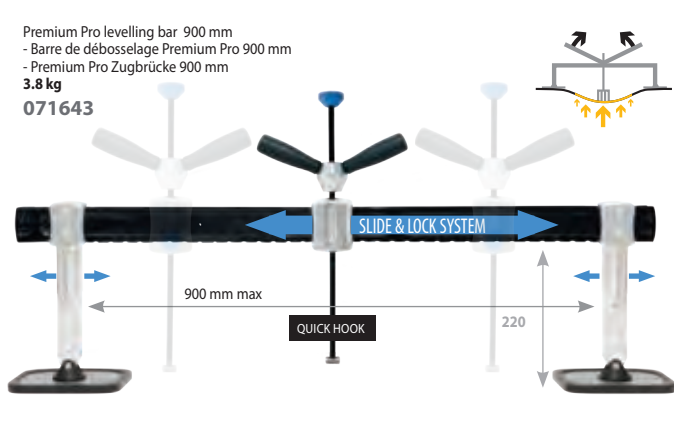

Premium Pro scissoring bar 900 mm  
- Barre de tirage Premium Pro 900 mm  
- Premium Pro Scherenzugbrücke 900 mm  
4.5 kg  
072305

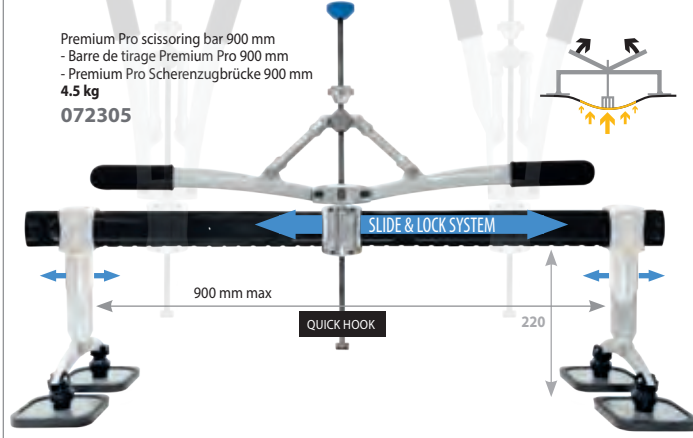

Premium Pro Levelling lever  
- Levier de débosselage Premium Pro  
- Premium Pro Zughebel  
1.6 kg  
072619

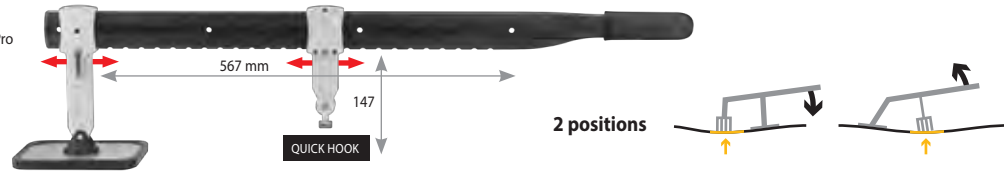

Premium Pro scissoring bar 1184 mm  
- Barre de tirage Premium Pro 1184 mm  
- Premium Pro Scherenzugbrücke 1184 mm  
072626



## OPTIONS

1.3 kg 072312 QUICK HOOK

0.7 kg 071650 QUICK HOOK

Pull with screwdriver 072633 QUICK HOOK

PREMIUM QUICK HOOK Premium Pro 2-teeth hook 072664

PREMIUM QUICK HOOK Premium Pro 3-teeth hook 072671

4 072640 6 072657

Arcpuller Premium PRO 072572

Alu 4 065185

Alu 3 065178

x2 059351

x2 059375

x1 072688

x1 059320

x2 061293

## PREMIUM BAR SMARTHAND

GYS Premium Bar SmartHand for Premium & Premium Pro 072480

210 cm

zoom



## TROLLEYS / CHARIOTS

Dent 600  
44 x 62 x 35 cm / 6,9 kg  
60 x 14 x 39 cm / 7,4 kg  
072831



Dent 1000  
44 x 95 x 35 cm / 9,3 kg  
60 x 14 x 39 cm / 9,9 kg  
072848



Universal 800  
83 x 48 x 60 cm / 17,6 kg  
15 x 52 x 80 cm / 18,1 kg  
051331

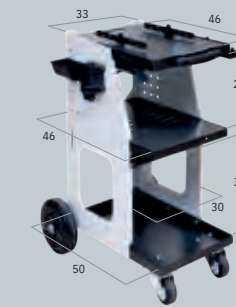

Weld 810  
84 x 50 x 77 cm / 20,1 kg  
14 x 80 x 51 cm / 21,6 kg  
037489

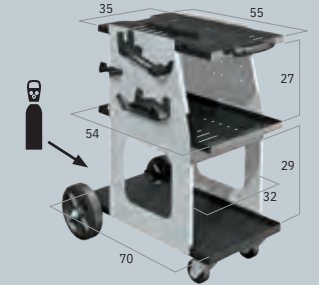

Dent 1600  
69 x 161 x 70 cm / 35,8 kg  
103 x 22 x 66 cm / 38,7 kg  
072596

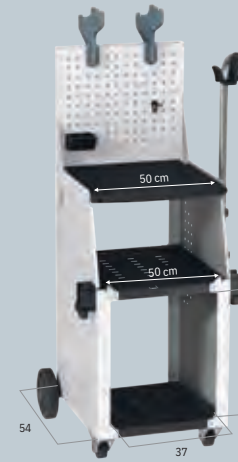

Dent 1600 WD  
71 x 161 x 70 cm / 49,5 kg  
103 x 22 x 66 cm / 52,4 kg  
072169

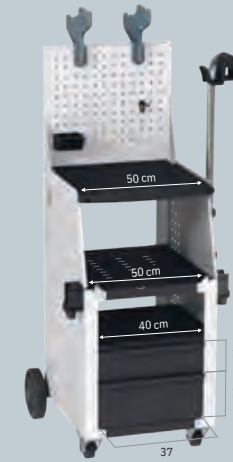

Dentstation Pro WD  
71 x 161 x 90 cm / 65 kg  
120 x 28 x 80 cm / 68,5 kg  
072800



Weld 910  
84 x 52 x 89 cm / 25 kg  
22 x 80 x 52 cm / 27 kg  
070967

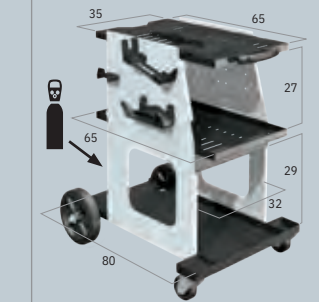

## DENT PULLING WORKSTATIONS

A COMPLETE SOLUTION  
UNE SOLUTION COMPLÈTE  
KOMPLETTLÖSUNGEN

### SPOTLINER

SPOT (guns & consumables included)	UNIVERSAL 800 051331	Cable support 052284	Levelling bar double action 053564 + Dent box bar 050037
3900 - 230V 035812	SPOT 3900-230V	✓	✓
3900 - 400V 035829	SPOT 3900-400V	✓	✓
PRO 230 028425	SPOT PRO 230	✓	✓
PRO 400 028432	SPOT PRO 400	✓	✓



SPOTLINER  
STEEL / ACIER / STAHL

ALU

SPOT (guns & consumables included)	Weld 810 037489	Cable support 052284	Arcpuller premium 065161	SPOT (guns & consumables included)	UNIVERSAL 800 051331	Cable support 052284	Alu puller 051003
ARC PULL 200 065369	SPOT ARC PULL 200	✓	✓	ALU FV 034952	SPOT ALU FV	✓	✓



## SMARTLINER

SPOT (guns & consumables included)	DENT 1600 072596	Cable support 052284	Levelling bar 050693	Multihook heads 049758	Alu Box Ø5 & 6 048195	Alu puller 051003	Alu hammers 020986	Set of pencil punches with 6 teflon tips 052888	Stainless steel brush 044258	Hot air gun 650°C 066311	Infrared Thermometer 052994			
ALU FV 075740	SPOT ALU PRO FV					✓								
SPOT (guns & consumables included)	DENT 1600 072596	Cable support 052284	Manuspot 050679	Levelling bar 050693	Levelling lever 050686	052451	Multihook heads 049758+049734	3 lifting rods 050792	Dent box consumables 051515	Magnetic earth 049666	Ringmatic 052154	Alu puller 051003	Arcpuller premium 065161	4 m³ support 059665
3900 - 230V 075658	SPOT 3900 - 230V				✓									
3900 - 400V 075665	SPOT 3900 - 400V													
PRO 230 075672	SPOT PRO 230													
PRO 400 075869	SPOT PRO 400													
EXPERT 230 075696	SPOT EXPERT 230				✓						✓			
EXPERT 400 075702	SPOT EXPERT 400													
COMBISpot 230 075719	COMBISpot 230	✓	×2			✓						✓		
ARCPULL 200 + EXPERT 230 075726	SPOT ARCPULL 200 + EXPERT 230	✓	×2			✓								✓
ARCPULL 200 + EXPERT 400 075733	SPOT ARCPULL 200 + EXPERT 400													
without generator 035058												✓		

## SMARTLINER PREMIUM

SPOT (guns & consumables included)	DENT 1600 WD 072169	Cable support 052284	Premium levelling bar 059306	Hook head 059382	3 lifting rods 050792	Alu Ring Box 1 mm 059412	Arcpuller premium 065161	Alu hammers 020986	Set of pencil punches with 6 teflon tips 052888	Infrared Thermometer 052994	4 m³ support 059665	Stainless steel brush 044258	Hot air gun 650°C 066311	Alu Ring Box 1,5 mm 059429	Ring holder 059610
ARCPULL 200 075887	SPOT ARCPULL 200						✓								
SPOT (guns & consumables included)	DENT 1600 WD 072169	Cable support 052284	Manuspot 050679	Ringmatic 052154	Manual pulling handle 057289	Premium levelling bar 059306 + Premium levelling lever 059290	Hook head 049758 + 059658 + 059382	3 lifting rods 050792	Dent box consumables 051515	Magnetic earth 049666	Fast pulling rings (x5) 058712 + Alu puller 051003	Arcpuller premium 065161	4 m³ support 059665		
PRO 230 075757	SPOT PRO 230														
PRO 400 075764	SPOT PRO 400														
EXPERT 230 075771	SPOT EXPERT 230					✓									
EXPERT 400 075795	SPOT EXPERT 400														
COMBISpot 230 075818	COMBISpot 230	✓	×2				✓					✓			
COMBI ARCPULL 075825	COMBI ARCPULL														
ARCPULL 200 + EXPERT 230 075788	SPOT ARCPULL 200 + EXPERT 230	✓	×2				✓								✓
ARCPULL 200 + EXPERT 400 075801	SPOT ARCPULL 200 + EXPERT 400														



✓ ALU PRO FV 075740

SMARTLINER ALU STEEL / ACIER / STAHL



✓ COMBISpot 230  
✓ ARCPULL 200 + EXPERT 230  
✓ ARCPULL 200 + EXPERT 400 075788

SMARTLINER PREMIUM ALU + STEEL / ACIER / STAHL



✓ COMBISpot 230  
✓ ARCPULL 200 + EXPERT 230  
✓ ARCPULL 200 + EXPERT 400 075726

SMARTLINER ALU + STEEL / ACIER / STAHL



✓ ARCPULL 200 075887

SMARTLINER PREMIUM ALU STEEL / ACIER / STAHL

✓ PRO 230, PRO 400  
✓ EXPERT 230, EXPERT 400 075771



## DENTSTATION

SPOT (guns & consumables included)	Dentstation Pro WD 072800 + Fixing kit 051362	Cable support 052284	Manuspot 050679	Ringmatic 052154	Manual pulling handle 057289	Levelling lever 050686 + Levelling bar 050693 + Scissoring bar 050716	Double pads 050723 + Strengthened bar 051171 + Extensions (x2) 052451	Multihook heads 049758 +049734 +049741	3 lifting rods 050792	Dent box consumables 051515 + Empty box 320x 113mm	Magnetic earth 049666	Fast pulling rings (x5) 058712 + Alu puller 051003	Arcpuller premium 065161	4 m <sup>3</sup> support 059665 + Flanges (x 2) 062146
3900 - 230V 078178	SPOT 3900 - 230V					✓								
3900 - 400V 078192	SPOT 3900 - 400V													
PRO 230 078215	SPOT PRO 230													
PRO 400 078277	SPOT PRO 400													
EXPERT 230 078376	SPOT EXPERT 230					✓								
EXPERT 400 078451	SPOT EXPERT 400													
COMBISPOT 230 078536	COMBISPOT 230	✓	x2				✓					✓		
ARCPULL 200 + EXPERT 230 078390	SPOT ARCPULL 200 + EXPERT 230	✓	x2				✓							✓
+ EXPERT 400 078475	SPOT ARCPULL 200 + EXPERT 400													

## DENTSTATION PREMIUM

SPOT (guns & consumables included)	Dentstation Pro WD 072800 + Fixing kit 051362	Cable support 052284	Manuspot 050679	Ringmatic 052154 + Manual pulling handle 057289	Manual pulling handle 057289 + Premium levelling lever 059290 + Premium levelling bar 059306 + Premium scissoring bar 058996 + Premium levelling lever 1200 059313	Premium double pads support 150 mm 059351 + 220 mm 059375	Hook head 049734 + 059658 + 059382	3 lifting rods 050792	Dent box consumables 051515 + Empty box 320x 113mm	Magnetic earth 049666	Fast pulling rings (x5) 058712 + Alu puller 051003	Arcpuller premium 065161	4 m <sup>3</sup> support 059665 + Flanges (x 2) 062146
PRO 230 078246	SPOT PRO 230												
PRO 400 078307	SPOT PRO 400												
EXPERT 230 078413	SPOT EXPERT 230												
EXPERT 400 078499	SPOT EXPERT 400												
COMBISPOT 230 078550	COMBISPOT 230	✓	x2			✓						✓	
COMBISPOT ARCPULL 078574	COMBISPOT ARCPULL												
ARCPULL 200 + EXPERT 230 078437	SPOT ARCPULL 200 + EXPERT 230	✓	x2			✓							✓
+ EXPERT 400 078512	SPOT ARCPULL 200 + EXPERT 400												



DENTSTATION STEEL / ACIER / STAHL

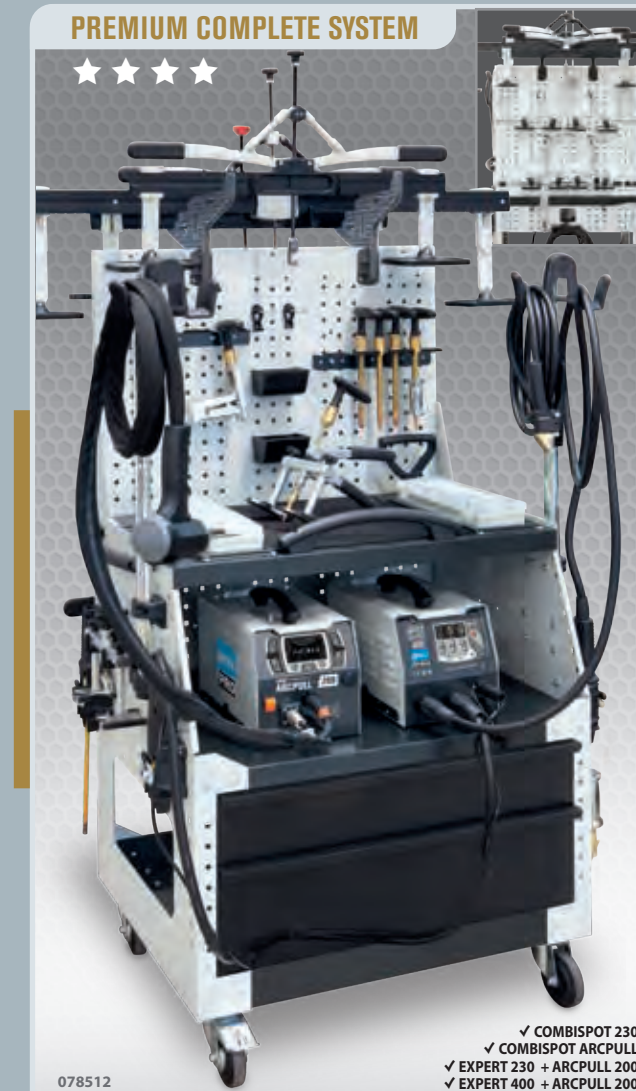

DENTSTATION PREMIUM ALU + STEEL / ACIER / STAHL

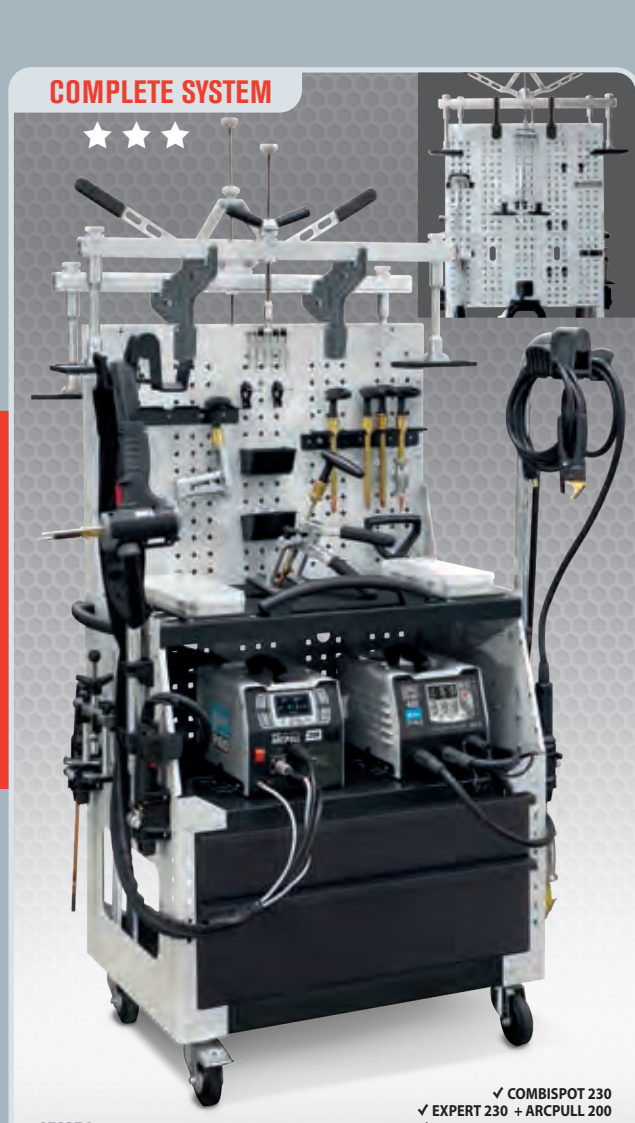

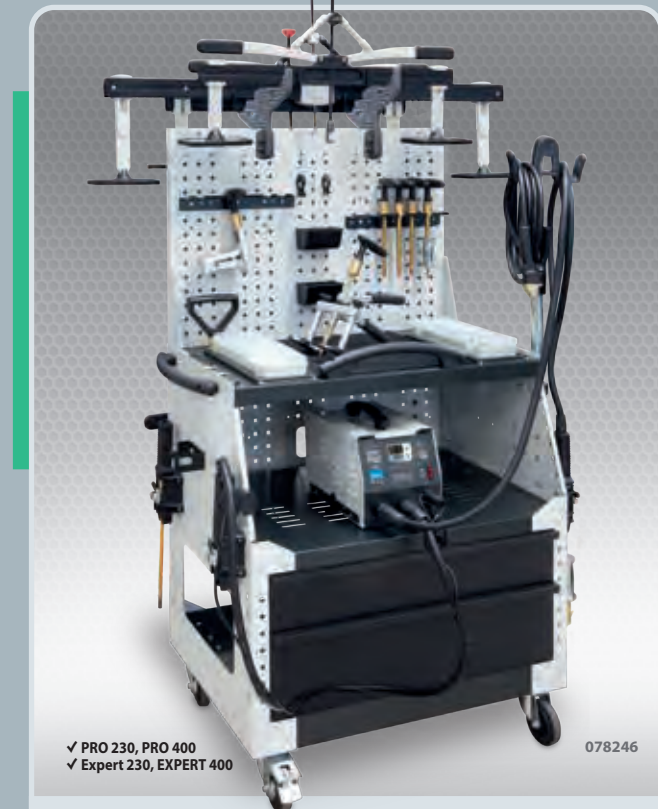

DENTSTATION ALU + STEEL / ACIER / STAHL







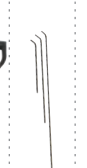









DENTSTATION PREMIUM STEEL / ACIER / STAHL



 SPOT EXPERT 230 (guns & consumables included) 066892	 Dentstation Pro WD 072800	 Manuspot 050679	 Ringmatic 052154	 Manual pulling handle 057289	 3 lifting rods 050792	 Dent box consumables 051515	 Magnetic earth 049666	 Levelling bar & scissoring bar Premium Pro 072305 - 071643 072619 - 072626	 071650 072312	 Gripping hook head 072664 - 072671 072640 - 072657	 Double padded feet 270 mm 072688
STEEL ACCESSORIES PACK 073821											
SPOT EXPERT 230 + DENTSTATION PRO WD + STEEL ACCESSORIES PACK = 075832											

 SPOT EXPERT 400 (guns & consumables included) 058941	 Dentstation Pro WD 072800	 Manuspot 050679	 Ringmatic 052154	 Manual pulling handle 057289	 3 lifting rods 050792	 Dent box consumables 051515	 Magnetic earth 049666	 Levelling bar & scissoring bar Premium Pro 072305 - 071643 072619 - 072626	 071650 072312	 Gripping hook head 072664 - 072671 072640 - 072657	 Double padded feet 270 mm 072688
STEEL ACCESSORIES PACK 073821											
SPOT EXPERT 400 + DENTSTATION PRO WD + STEEL ACCESSORIES PACK = 075849											

 COMBISPOT ARCPULL (guns & consumables included) 075627	 Dentstation Pro WD 072800	 Manuspot 050679	 Ringmatic 052154	 Manual pulling handle 057289	 3 lifting rods 050792	 Dent box consumables 051515	 Magnetic earth 049666	 Levelling bar & scissoring bar Premium Pro 072305 - 071643 072619 - 072626	 071650 072312	 Gripping hook head 072664 - 072671 072640 - 072657	 Double padded feet 270 mm 072688	 Potence pour servantes de débosselage 052284	 4 m³ support 059665	 Arcpuller Premium Pro 072572
STEEL ACCESSORIES PACK 073821														
ALU ACCESSORIES PACK 073838														
COMBISPOT ARCPULL + DENTSTATION PRO WD + STEEL ACCESSORIES PACK + ALU ACCESSORIES PACK = 075863														

 SPOT EXPERT 400 + ARCPULL 200 (guns & consumables included) 058941 + 059405	 Dentstation Pro WD 072800	 Manuspot 050679	 Ringmatic 052154	 Manual pulling handle 057289	 3 lifting rods 050792	 Dent box consumables 051515	 Magnetic earth 049666	 Levelling bar & scissoring bar Premium Pro 072305 - 071643 072619 - 072626	 071650 072312	 Gripping hook head 072664 - 072671 072640 - 072657	 Double padded feet 270 mm 072688	 Potence pour servantes de débosselage 052284	 4 m³ support 059665	 Arcpuller Premium Pro 072572
STEEL ACCESSORIES PACK 073821														
ALU ACCESSORIES PACK 073838														
SPOT EXPERT 400 + ARCPULL 200 + DENTSTATION PRO WD + STEEL ACCESSORIES PACK + ALU ACCESSORIES PACK = 075856														

 SPOT EXPERT 400 + ARCPULL 350 (guns & consumables included) 058941 + 066762	 Dentstation Pro WD 072800	 Manuspot 050679	 Ringmatic 052154	 Manual pulling handle 057289	 3 lifting rods 050792	 Dent box consumables 051515	 Magnetic earth 049666	 Levelling bar & scissoring bar Premium Pro 072305 - 071643 072619 - 072626	 071650 072312	 Gripping hook head 072664 - 072671 072640 - 072657	 Double padded feet 270 mm 072688	 Potence pour servantes de débosselage 052284	 4 m³ support 059665	 Arcpuller Premium Pro 072572	 Alu Ring Box 1,5 mm 059429 - 059610
STEEL ACCESSORIES PACK 073821															
ALU ACCESSORIES PACK 073838															
SPOT EXPERT 400 + ARCPULL 350 + DENTSTATION PRO WD + STEEL ACCESSORIES PACK + ALU ACCESSORIES PACK = 076037															

STEEL ACCESSORIES



075832

DENTSTATION PREMIUM PRO EXPERT 230

STEEL ACCESSORIES



075849

DENTSTATION PREMIUM PRO EXPERT 400

STEEL & ALU ACCESSORIES



075863

DENTSTATION PREMIUM PRO COMBISPOT ARCPULL

STEEL & ALU ACCESSORIES

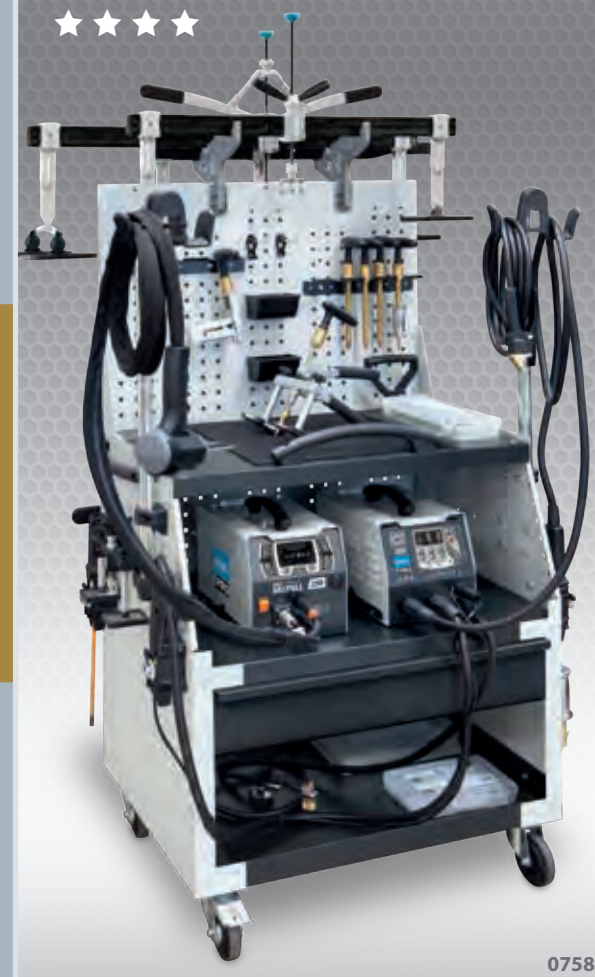

075856

DENTSTATION PREMIUM PRO EXPERT 400 + ARCPULL 200, 350





# PULLING SYSTEMS

AIRFIX DRAW ALIGNER	31
DRAW ALIGNER	32
FRAME STRAIGHTENING	34



## DRAW ALIGNER

### AIRFIX DRAW ALIGNER

Air 5-8 bars

077379

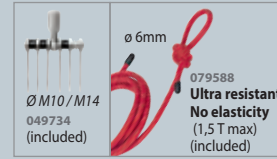

### 350 kg Uniform pulling force

Force de tirage uniforme  
Gleichmäßige Zugkraft



#### Precision

All directions

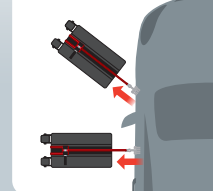

#### Down-pulling

Rocker panel  
- Bas de caisse  
- Schweller

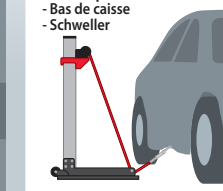

#### 4 pads

### Seal protection Perfect stability

4 patins : protection du joint, stabilité parfaite  
4 Pads: Dichtungsschutz, perfekte Stabilität



Seal - Joint - Rahmen

### Quick & easy set up



Compact & light  
31 kg

### Low noise



Integrated silencer

### Smart maintenance

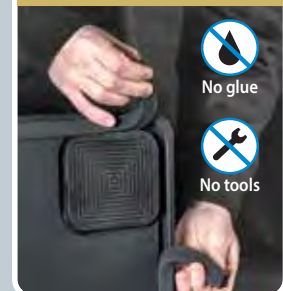

No glue

No tools



Pads - Patins (x2)  
069008



Plate seal - Joint de plaque  
079571



Designed for

- ★ Time saving
- ★ Maximum grip
- ★ Durability

### Ground anchor by suction Fast installation

Ancrage au sol par aspiration :  
installation rapide  
Verankerung durch Vakuumbildung -  
schnell einsatzfähig

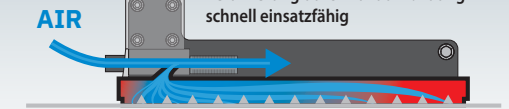





# PULLING SYSTEMS

## DRAW ALIGNER

Draw ligner - Équerre de tirage - Schnellausbeul-Richtausleger 052475

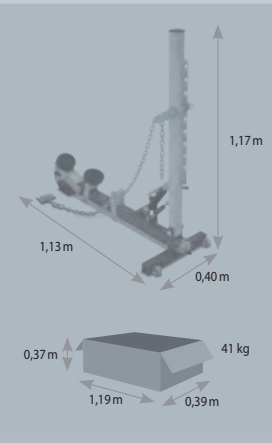
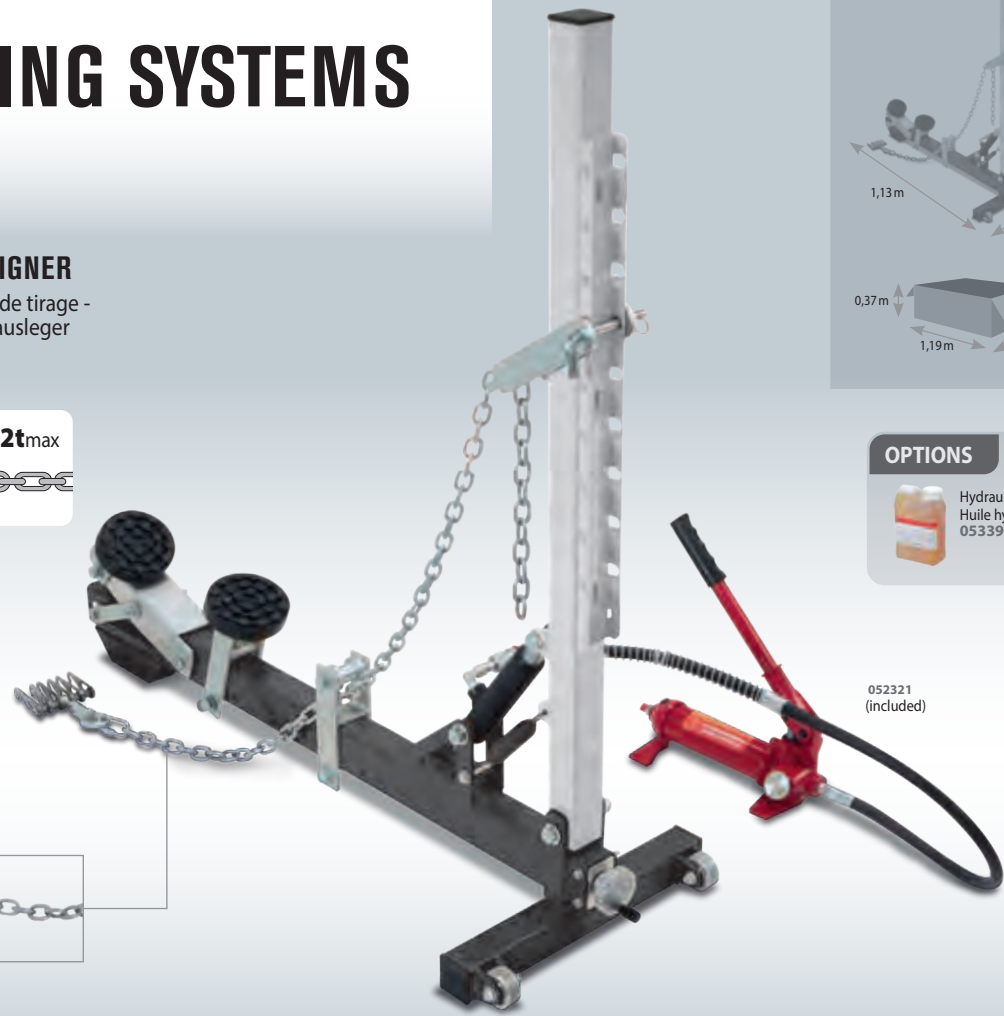
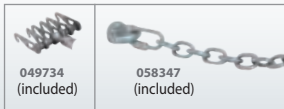
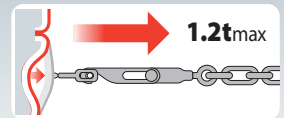

### OPTIONS

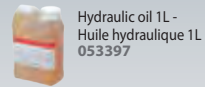

052321 (included)

### INCLUDED

Wedge for rocker panel - Cône pour bas de caisse

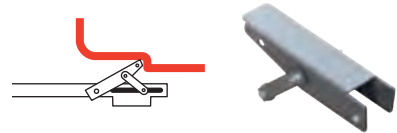

Pads kit for rocker panel - Kit patins pour bas de caisse

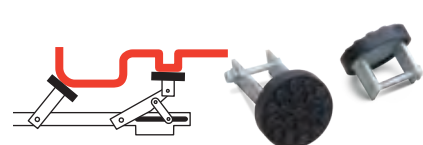

### OPTIONS

Rocker panel arms for draw aligner - Bras de bas de caisse - Abstütztraverse für Richtausleger

052581

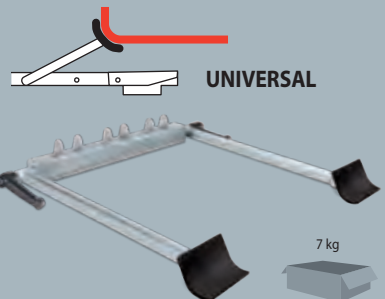

## DRAW ALIGNER PRO

069244

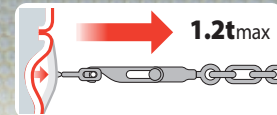

049734 (included)

058347 (included)

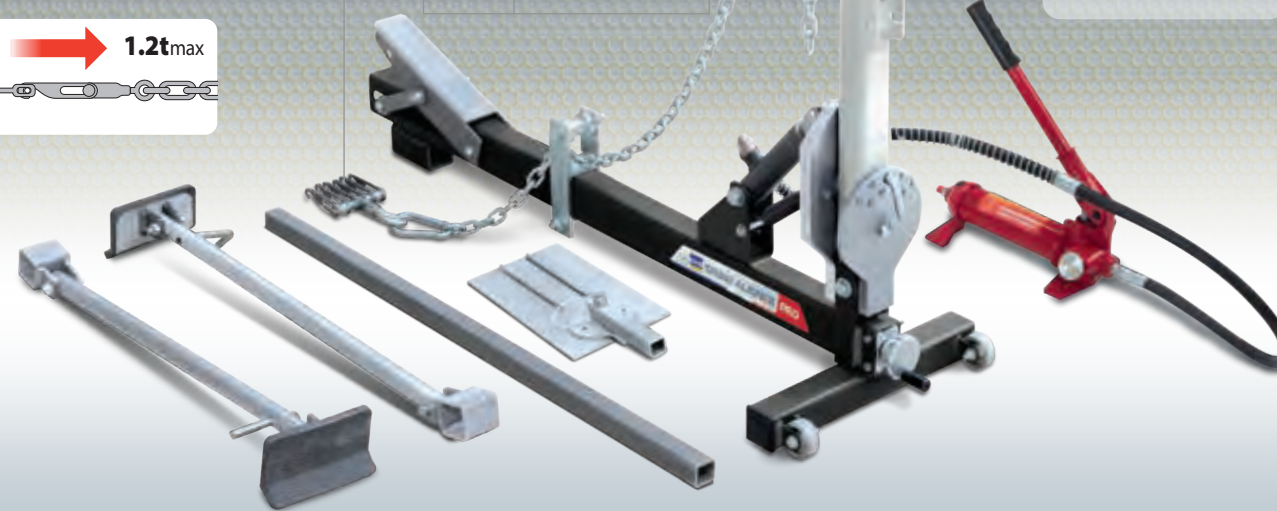

### OPTIONS

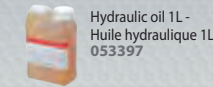

### INCLUDED

Plate under the wheel - Cône sous roue - Compatible with Draw Aligner & Draw Aligner Pro

076693



Wedge for rocker panel - Cône pour bas de caisse



Rocker panel arms and stabilisation bar - Kit bras de bas de caisse et barre de stabilisation

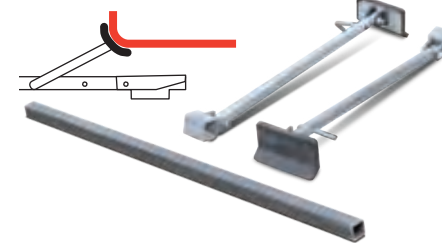

### OPTIONS

Pads kit for rocker panel - Kit patins pour bas de caisse

071278

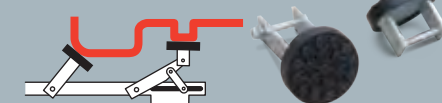



## SMART PULLER SILVER PULLING SYSTEM

- Système de tirage Smart puller silver - Schnellausbeul-Richtausleger Smart puller silver

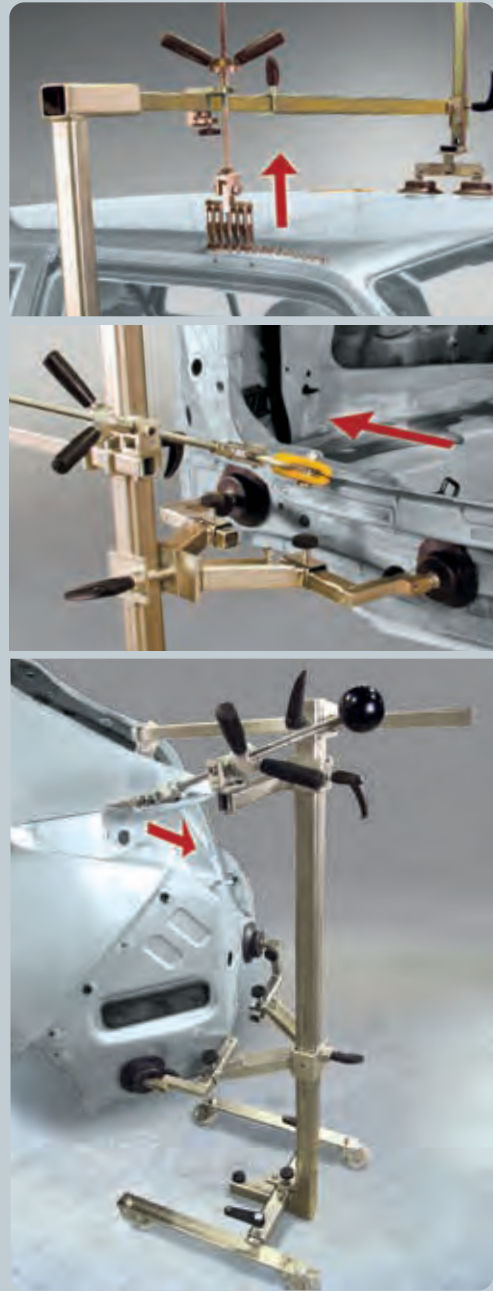

054820



- Doors - Portières - Türen
- Supports - Montants - Scheibenrahmen
- Hood/Bonnet - Capot - Haube
- Armature - Armature - Rahmen
- Rocker panel - Bas de caisse - Schweller
- Wings - Ailes - Kotflügel
- Roof - Toit - Dach
- Hatchback - Hayon - Heckdeckel

min: 0,60 m  
max: 2,00 m

min: 1,50 m  
max: 2,70 m

0,55 m

0,20 m

1,55 m

0,35 m

54 kg

**Autorobot**

**INCLUDED**

Accessories

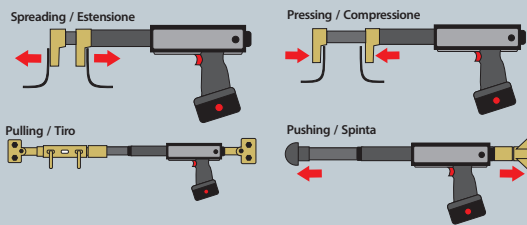

Applications / Applicazioni

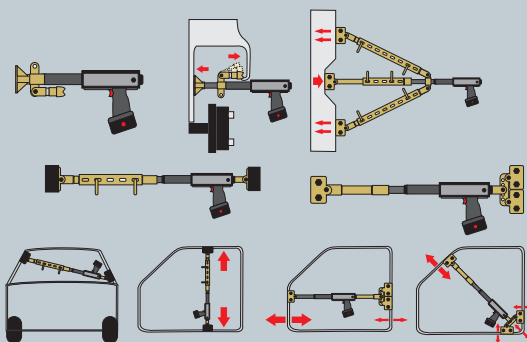

## ELECTRO POWER - Zug-Druckpresse

Non commercialisable en France

**OPTION**

Pince écarteur 079496

**NEW**

160 mm

140 mm

with accessories : 057425

-PULLING POWER: 5 Ton.  
-PUSHING POWER: 5 Ton.  
-PISTON  
-STROKE: 130 mm



**INCLUDED**

Standard kit : 425x620x210 mm  
Standard kit  
Total weight: 18 kg

057401

**INCLUDED**

Accessories kit : 425x620x150 mm  
Accessories kit  
Total weight: 20 kg

057418

Li-Ion battery (included) 058514

## HYDRAULIC CYLINDER KIT - Coffret vérin hydraulique - Hydraulischer Drucksatz

MADE IN CHINA

**BASIC 4T**  
052345



**BASIC 10T**  
052338



**PRO 4T**  
057432



**PRO 10T**  
057449



**OPTIONS**



Hydraulic oil 1L - Huile hydraulique 1L 053397

## ANCHOR BAR - Barre d'ancrage - Türspanner

MADE IN TAIWAN

053045



053052



## MEASURING TOOLS - Mesures - Vermessung

BODYMETER, Mechanical measurements

052130

250 > 2230 mm

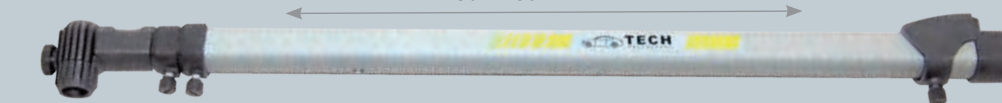

GYSMETER, Electronic measurements

052093

Measuring report

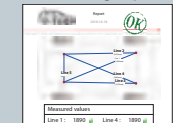

Light weight measuring arm with an easy to read digital display

400 > 2650 mm





**SWIVEL CLAMP**  
- Pince pivotante

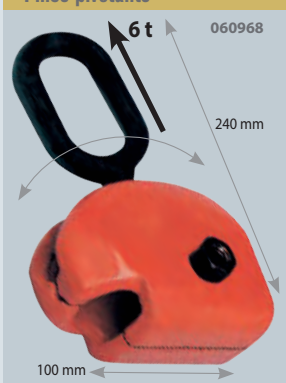

**FRAME STRAIGHTENING - Pinces de tirage - Ziehwerkzeuge**

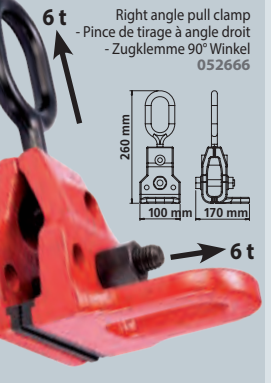
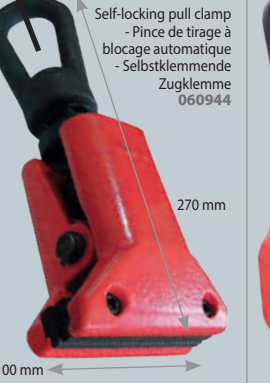
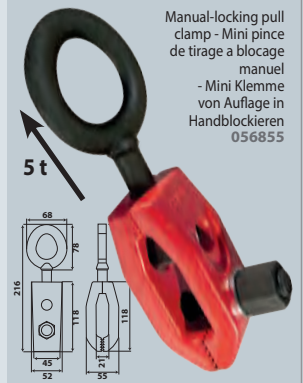

**FRAME STRAIGHTENING - Crochet de tirage - Ziehwerkzeuge**

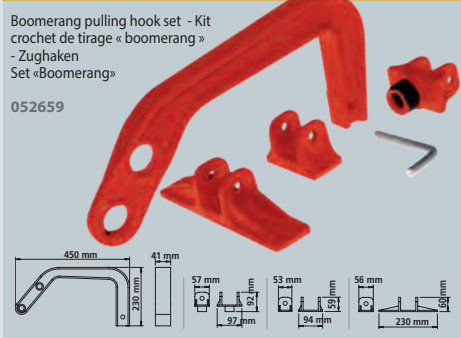

**ARCH HOOKS - Passage de roue**

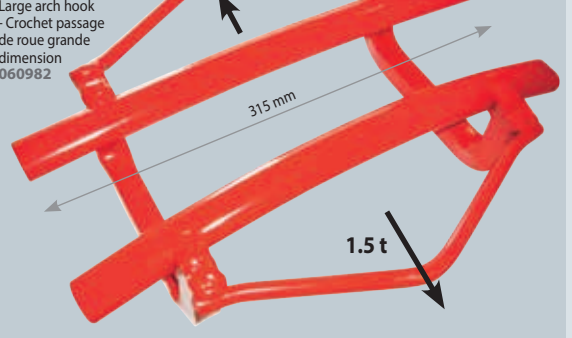
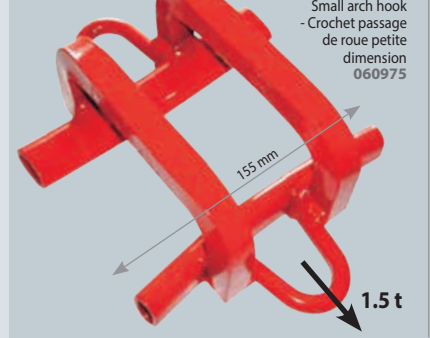

**FRAME STRAIGHTENING - Chaînes de tirage - Ziehwerkzeuge**

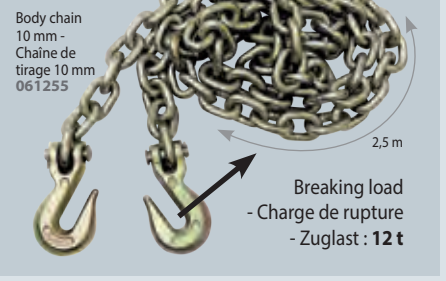
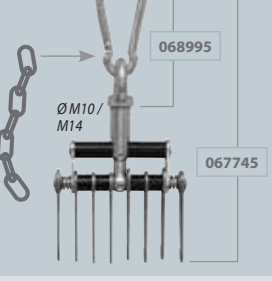
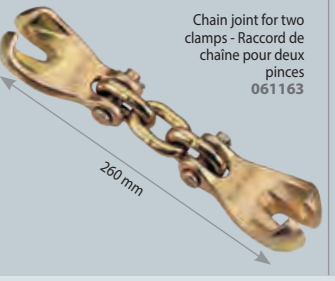
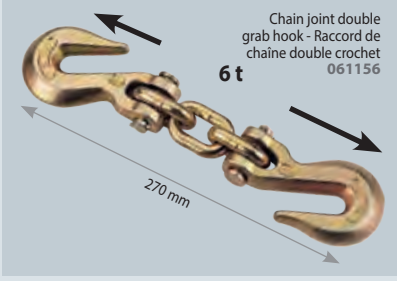

**WIDE PULL CLAMPS - Pinces de tirage larges**

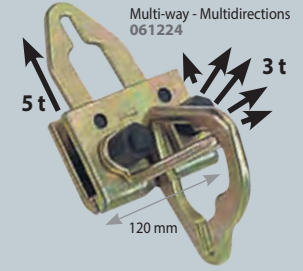
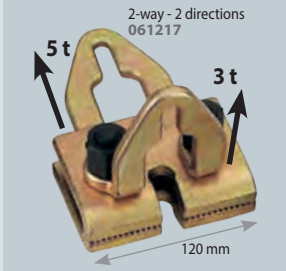

**SMALL PULL CLAMPS - Pinces de tirage faible largeur**

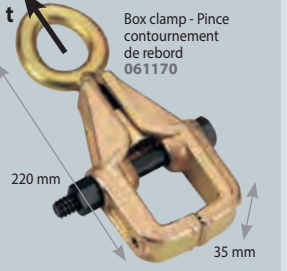
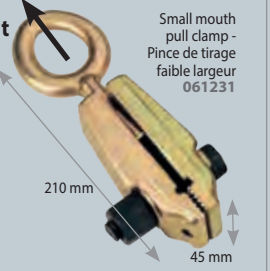
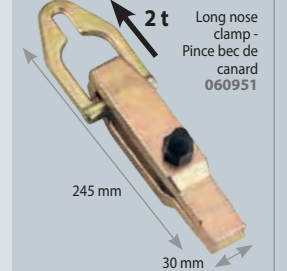

**MULTIPLE PULL CLAMP**  
- Pince de tirage multiple

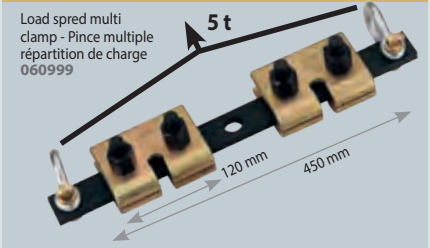

**45 MM SCISSORS CLAMP**  
- Pince ciseaux largeur 45 mm

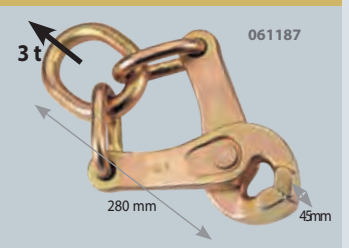

**90 DEGREE CORNER CLAMP**  
- Pince de tirage pour angle 90°



**C TYPE CLAMP**  
- Pince de tirage type C

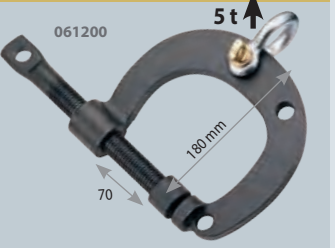

**INERTIA HAMMER KIT - Kit marteau à inertie - Ausziehhammer kit**

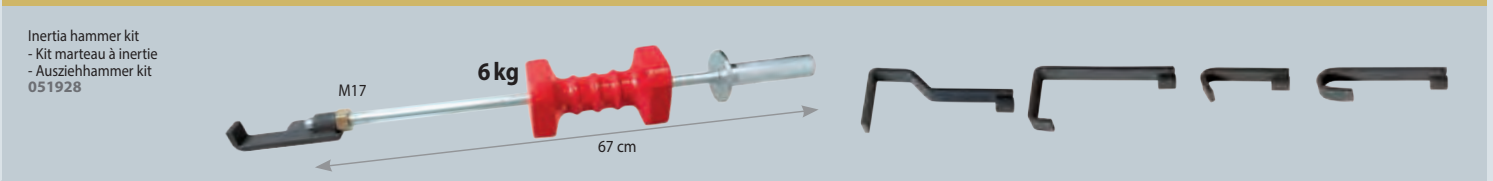

**SMART SATELLITE - Satellite intelligent - Satellite Komplett-Kit**

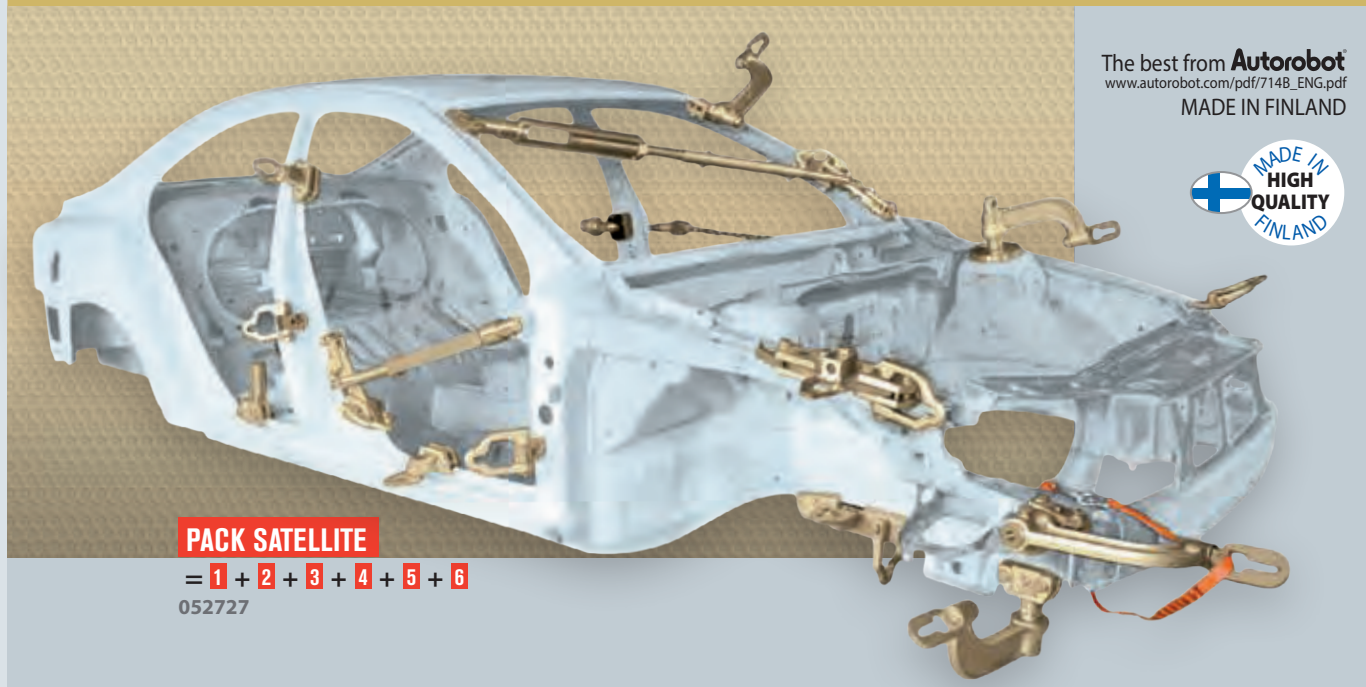

The best from **Autorobot**  
www.autorobot.com/pdf/7148\_ENG.pdf  
MADE IN FINLAND



**PACK SATELLITE**  
= 1 + 2 + 3 + 4 + 5 + 6  
052727

**1 SATELLITE**  
- Satellite - Satellite Basisbügel-Set



**2 MAC PHERSON KIT** - Kit Mac Pherson (A) - Befestigungskit-Federbein (McPherson)



**3 PUSH/PULL BAR**  
- Barre pour tirer/pousser - Zug/Druck-Stangenset

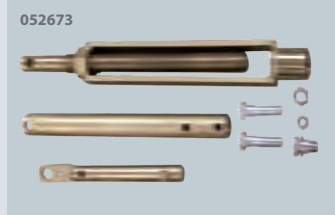

**4 SATELLITE (B)**  
- Bügelverlängerung

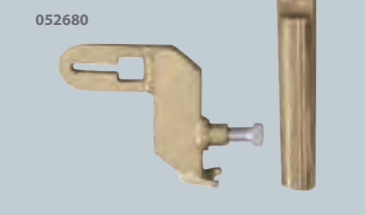

**5 SAFETY STRAP**  
- Sangle de sécurité - Sicherungsgurt



**6 DOUBLE CLAMP SATELLITE**  
- Double pince satellite (C) - Satellite Doppelklemme



**VERSATILE PULLING CLAMP**  
- Pince de tirage multi-usage - Multifunktions-Zugklemme



**POWER-PULLER 4T**

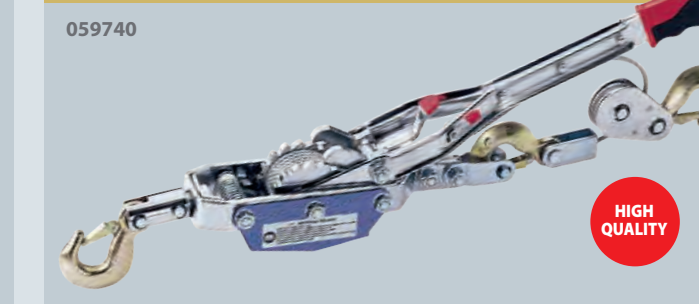



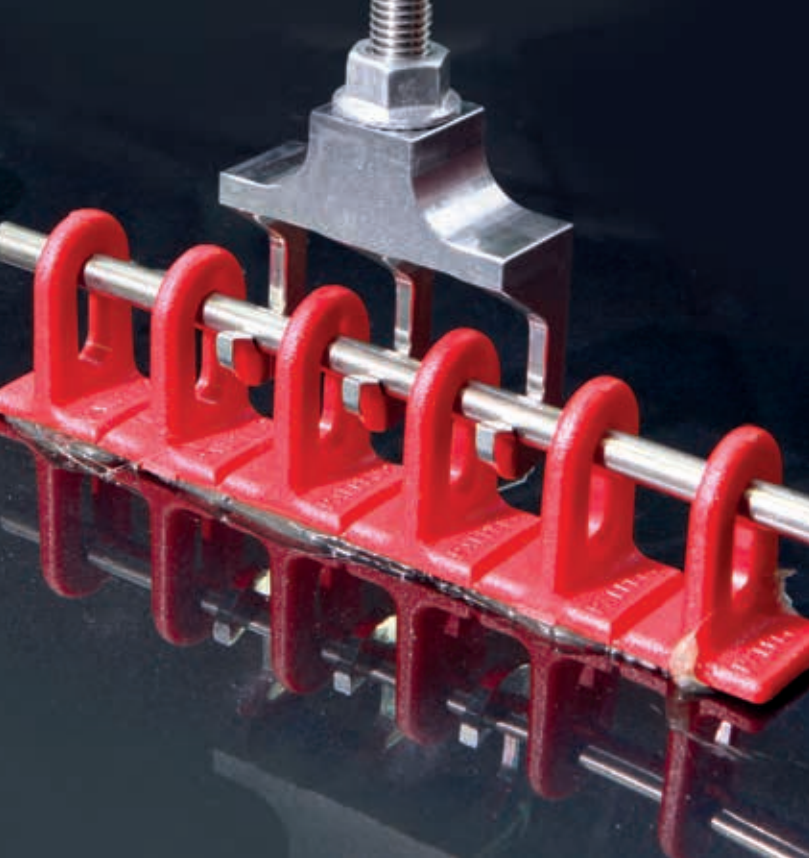

# PAINTLESS DENT REPAIR

## PAINTLESS DENT REPAIR MAGNETIC KIT

- Kit magnétique de débosselage sans peinture  
- Magnetisches Ausbeul-Kit

053168

**EXELTOOLS**

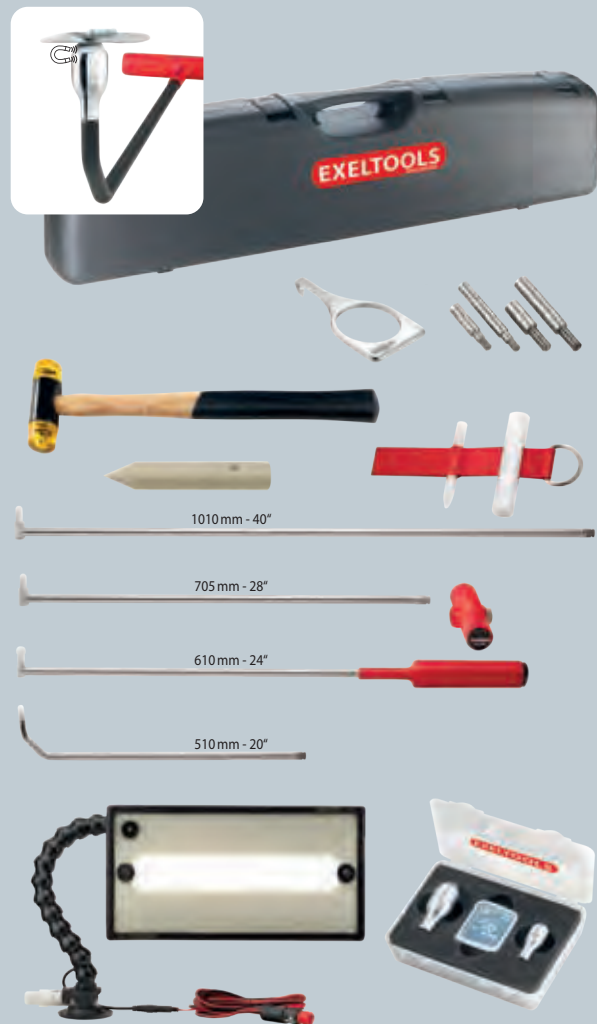

## DENT PULLING INDUCTOR

- Inspection carrosserie - Ausbeul Induktor

Planche flexible pour inspection de la carrosserie - Ausbeul-Matrix Ø 800 mm

059122

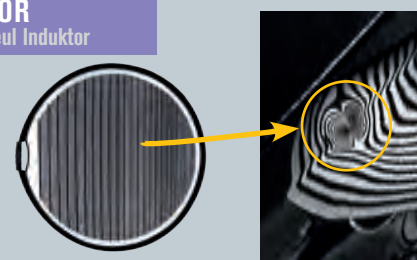

## PAINTLESS DENT REPAIR LAMPS

- Lampes de débosselage  
- Ausbeullampe

ULTRA LIGHT CARBON X40 PW  
053175

**EXELTOOLS**



## DENT PULLING KIT (PAINTLESS)

- Kit débosselage sans peinture - Dellenausbeulhebel-Set

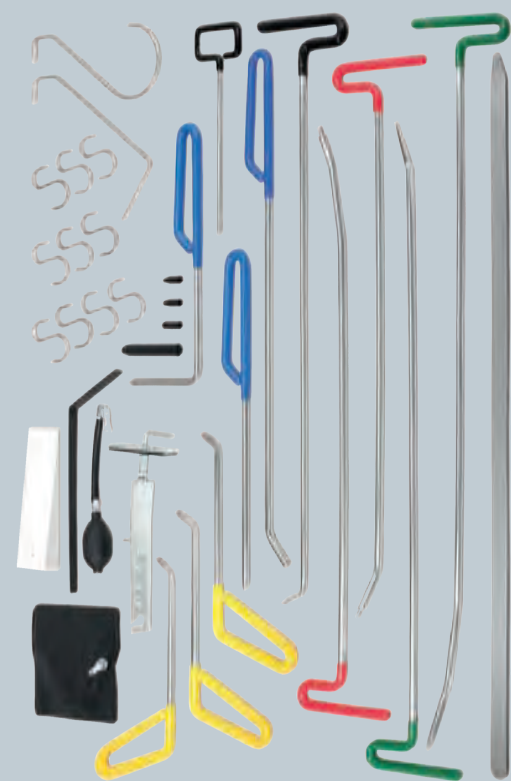

33 parts

051959



## SET OF 6 PENCIL PUNCHES

- Kit de 6 coins de frappe - Beulenstemmer-Satz mit 6 Tefloneinsätzen



052888



## PNEUMATIC INERTIA HAMMER

- Marteau inertie pneumatique - Unterdruck-Schlaghammer

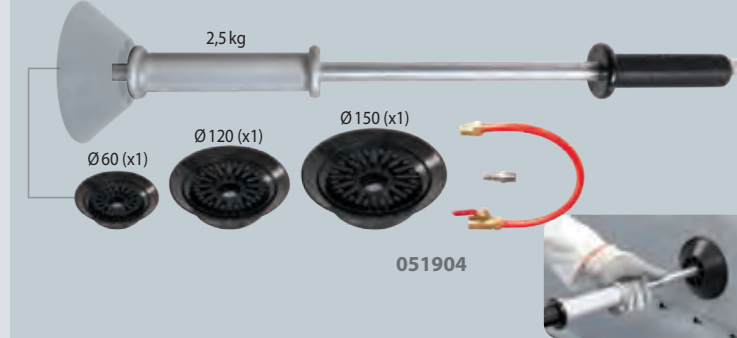

## PUMP AIR SUCTION SLIDE HAMMER

- Marteau à inertie à ventouses (pompage manuel)  
- Man. Unterdruck-Schlaghammer



## AIR CUSHION KIT

- Kit coussins gonflables  
- Luftpolster-Spreizkissen-Satz







PDR: Paintless Dent Repair  
- Débosselage rapide et sans peinture  
- Lackschadenfreies Ausbeulen

# PAINTLESS DENT REPAIR

## GLUE PULLER PRO (Steel/Alu • Acier/Alu)



MADE IN FRANCE

Glue Lifter 057364

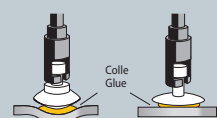

061392

Glue Puller PRO 058699

Glue Puller PRO EXPORT 230 V 059160

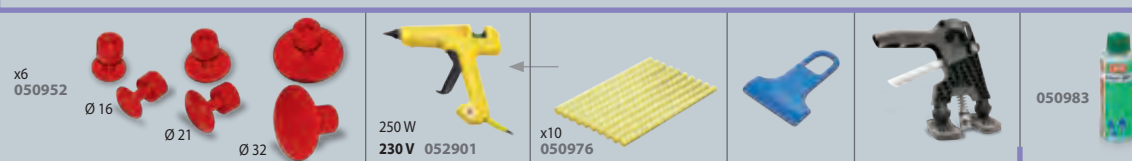

## PLASTIC MULTIPADS - Barrettes anneaux plastique - Ösen-Klebe pads

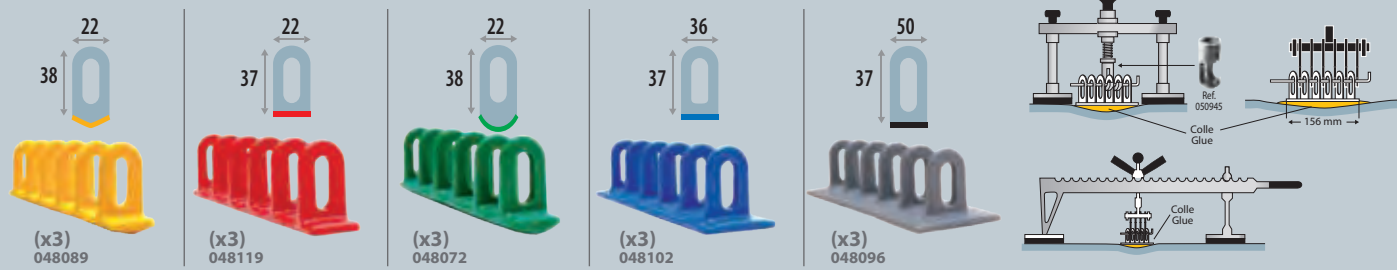

## OPTIONS

Pulling handle 3 claws - Poignée de tirage 3 dents - Handzugkralle 3-fach 057326



Slide hammer 380 g - Marteau à inertie 380 g - Gleithammer 380 g

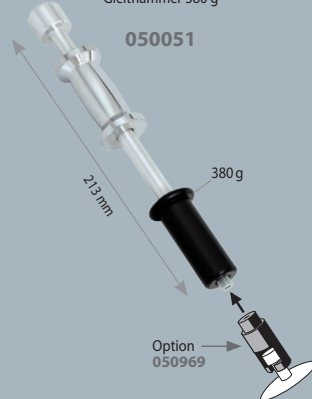

Slide hammer 500 g - Marteau à inertie 500 g - Gleithammer 500 g

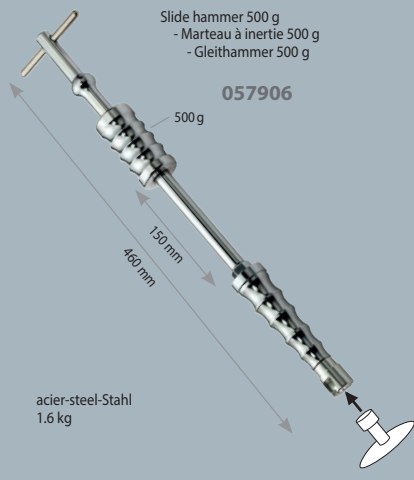

Set of 2 knives to cut glued reinforcements - Jeu de 2 couteaux pour découpe de renforts collés - 2-er Set Messer zur Klebepadentfernung



PDR: Paintless Dent Repair  
- Débosselage rapide et sans peinture  
- Lackschadenfreies Ausbeulen

# GLUE PULLING

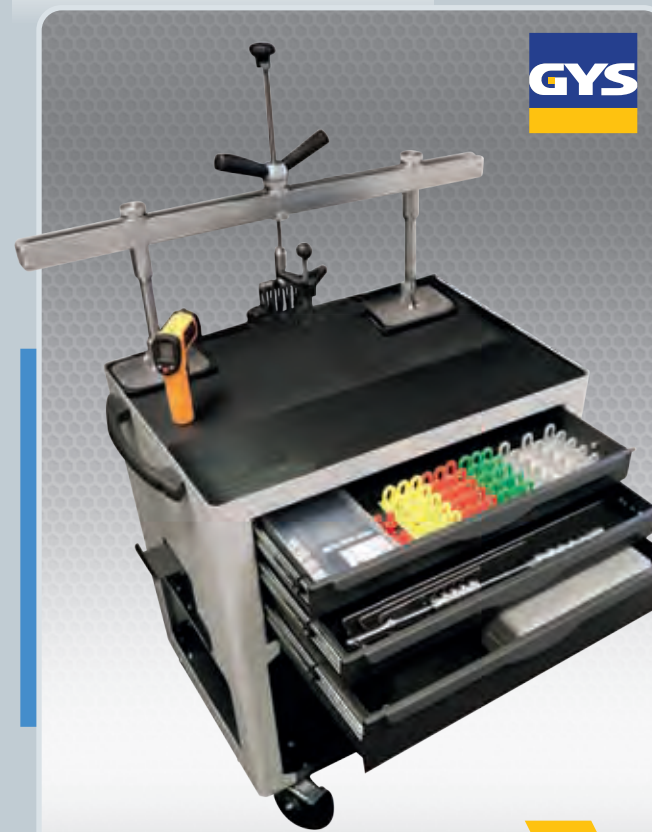

GYSMART GLUE PULLING KIT



GYSMART GLUE PULLING KIT PLUS

Workstation 054233	Set of pincil punches with 6 teflon tips 052888	Infrared thermometer 052994 Heat Gun 066311	Levelling bar 050693 6 Gripping multihook head 049734	3 Lifting rods 150/300/500 mm 050792	Set of 3 conical plastic multipads 048096 048072 048089 048119 048102	Inertia hammer 057906	Set of 6 glue tips 050952	Glue Puller PRO 058699	Glue Puller PRO Export 059160	33PC Paintless dent repair kit 051959 PDR Light ultra light carbon X40PW 053175	Mini puller 050921 Aluminium clamp 2 050945
--------------------	---	---	---	--------------------------------------	---	-----------------------	---------------------------	------------------------	-------------------------------	---	---

GYSMART GLUE PULLING KIT 076051					✓						
GYSMART GLUE PULLING KIT EXPORT 076105				✓					✓		
GYSMART GLUE PULLING KIT PLUS 076082					✓						✓
GYSMART GLUE PULLING KIT PLUS EXPORT 076129				✓						✓	





# TRUCK TOOLS & MOBILE LIFTS

## TRUCK TOOLS

TROLLEY IW1	44
MULTITOOL TRUCK	44

## CAR LIFTS

SPOT LIFT	45
ERGO LIFT / QUICK LIFT	48
AIR JACKS	49
MANUAL WHEEL LIFT	49



TROLLEY IW1 / MULTITOOL TRUCK

# TRUCK TOOLS

**TROLLEY IW1**  
Impact wrench trolley -  
Support de clé à choc

max 6.5 bar

max 20 kg

063136

### OPTIONS



Huile hydraulique  
- Hydraulic oil  
1l  
053397



Youtube

Weight, vibrations  
& torque suppression -  
Suppression du poids,  
des vibrations et du couple



High dexterity -  
Liberté de  
mouvement

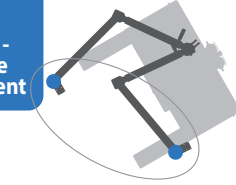

High maneuverability & stability -  
Grande maniabilité et stabilité

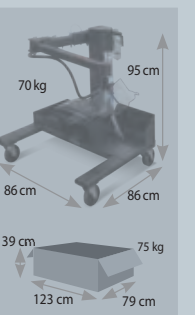
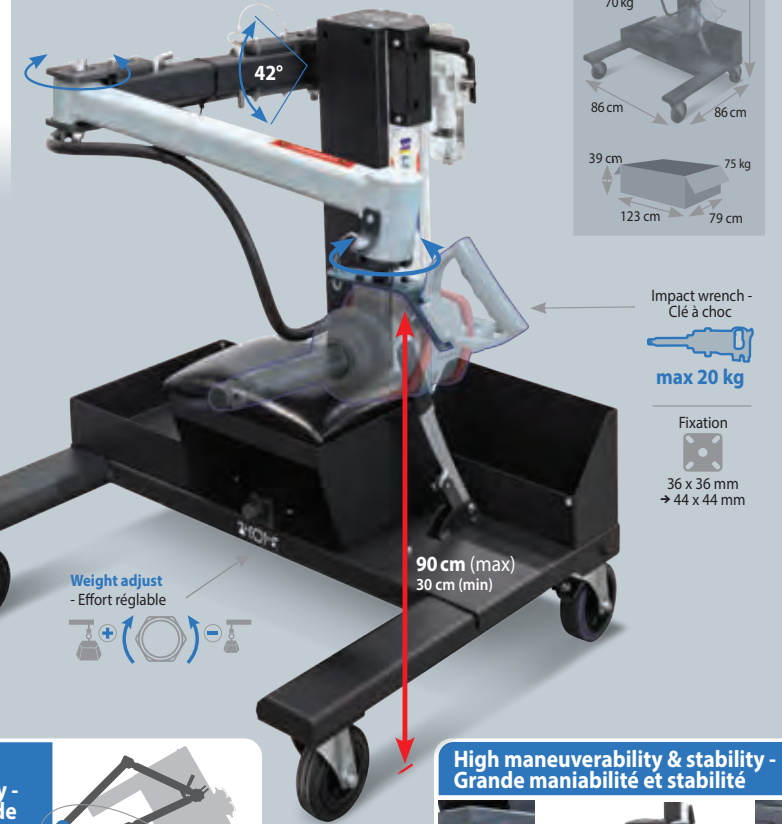

Impact wrench -  
Clé à choc  
max 20 kg

Fixation  
36 x 36 mm  
→ 44 x 44 mm

Weight adjust  
- Effort réglable

90 cm (max)  
30 cm (min)



**MULTITOOL TRUCK NEW**

SAFE EN 14238 + A1

max 200 kg

067158

### INCLUDED



Lifting tool for brake caliper  
- Outil de levage pour étrier  
de frein - Hebewerkzeug für  
Bremssattel



Brake caliper



Lifting tool for battery -  
Outil de levage pour batterie  
- Hebewerkzeug für Batterie

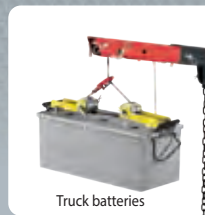

Truck batteries



Lifting tool for wheels -  
Outil de levage pour roues  
- Hebewerkzeug für Räder



SAFE  
EN 14238 + A1

ULTRA  
COMPACT  
103 cm

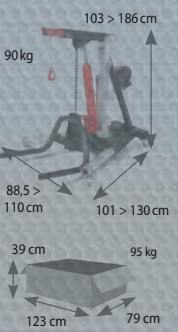

### HEALTH CARE

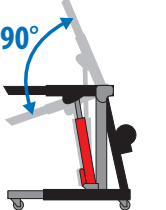
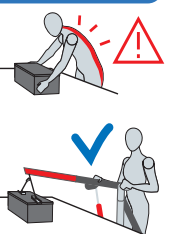





# SPOT LIFT

## MOBILE LIFTS CAR LIFT

### SPOT LIFT EASY

max Air 8 bar **SAFE EN 1494**  
**max 2.2 t**

#### HEALTH CARE

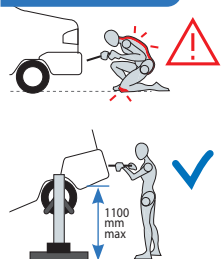

#### High stability - Haute stabilité

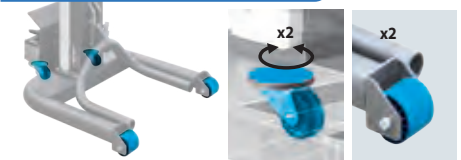

Included 220 bar 053588



**SAFE EN 1494**

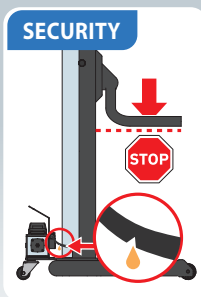

#### OPTIONS

Hydraulic oil 1L - Huile hydraulique 1L 053397

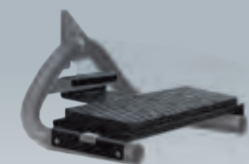

Rocker panel lifting tool - Outil de levage pour bas de caisse - Auflage für Seitenschweller 053236

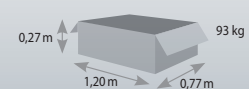
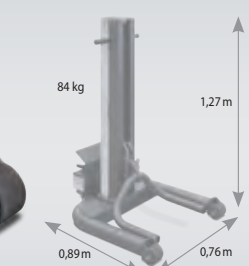
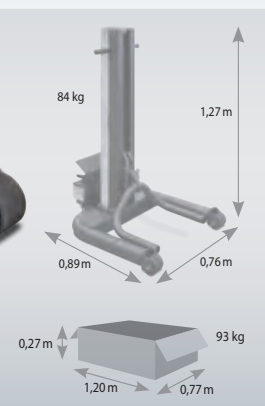

### SPOT LIFT PRO

max Air 8 bar **SAFE EN 1494**  
**max 2.2 t**

053557

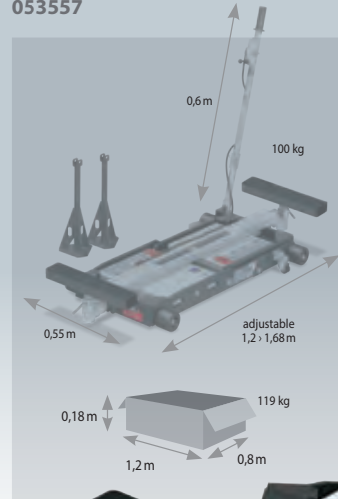

### SPOT LIFT PRO MOB

max Air 8 bar **SAFE EN 1494**  
**max 2.2 t**

055896

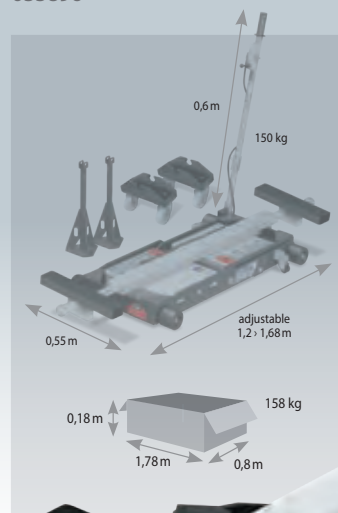

60 cm (max)  
14 cm (min)



#### OPTIONS

- Height adjuster for 4x4 & utility vehicles - Réhausseur pour 4x4 et utilitaires - Erhöhung f. 4x4 und Leicht-LKW



Patins - Pads for Audi & BMW (x 2) 053717

Rampes - Ramps 700 x 200 x 80 mm (x 2) 056787

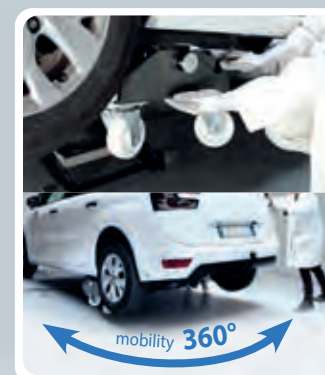

#### OPTIONS

**SPOT LIFT PRO MOB**  
Height adjuster for 4x4 & utility vehicles - Réhausseur pour 4x4 et utilitaires - Erhöhung f. 4x4 und Leicht-LKW



Patins - Pads for Audi & BMW (x 2) 061606

Rampes - Ramps 700 x 200 x 80 mm (x 2) 056787



### AUTO ROLL

min 500 mm max 1700 mm (AUTOROLL 1.0m) max 2240 mm (AUTOROLL 1.55m) **2.5 t max**

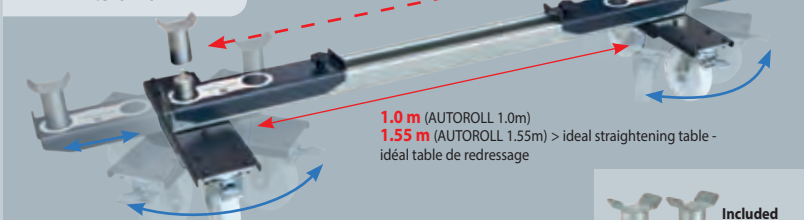

**AUTO ROLL 1.0 m / 1.2 t** 059047



**AUTO ROLL 1.55 m / 1.2 t** 063839

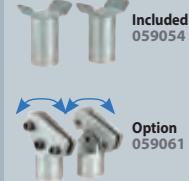

### AFTER LIFT AUTO ROLL

1 2 **2.5 t max**

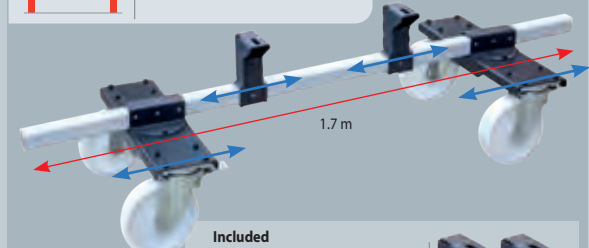

067967 45 Kg

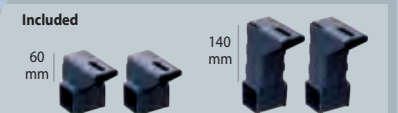

### WHEEL TROLLEYS - Tabourets de manutention - Radhocker

048768



### WHEEL TRUCKS - Chariots de manutention prise sous roue - Kfz-Montagelift, fahrbar

Mechanic jacks (x2) - Chariots mécaniques (x 2) 071995

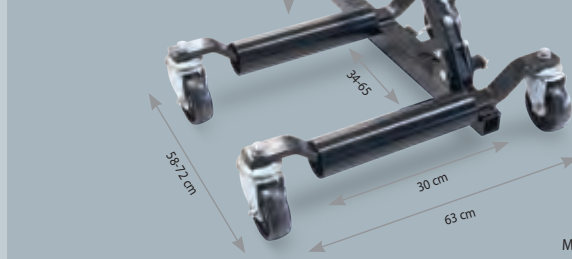

Made in China







ERGO LIFT / QUICK LIFT

# MOBILE LIFTS CAR LIFT



## ERGO LIFT 650

220 V, 1~  
**SAFE EN 1493**  
max 2 t



056817

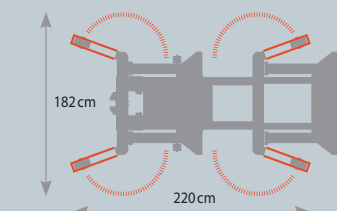
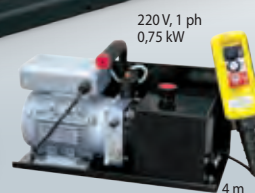
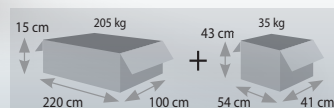
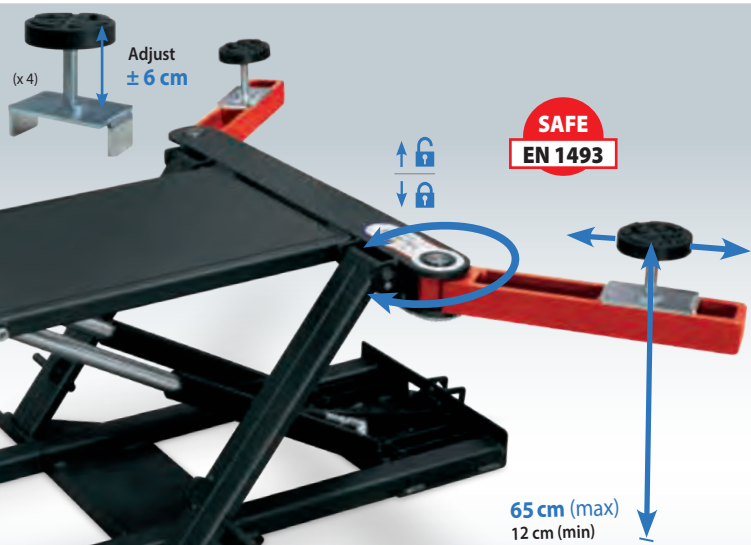

**ERGO LIFT 1000 ROLL**  
Air 7-8 bars  
max 2.5 t  
**SAFE EN 1493**

**NEW**

**GYS**

076792

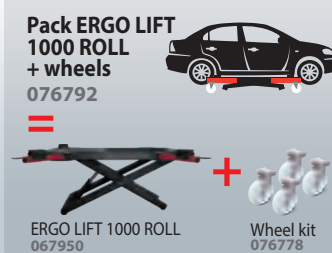
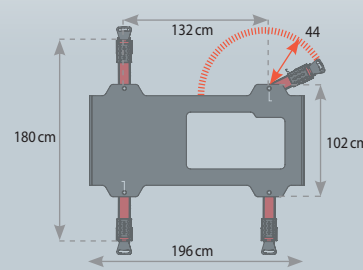

## QUICK LIFT L520E

062184

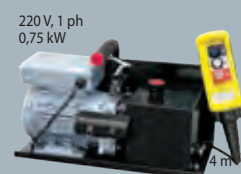

220 V, 1 ph  
0,75 kW

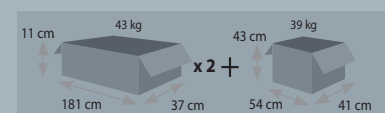

Made in China

**SAFE EN 1493**

2.5 t max

### OPTIONS

Set of 4 rubber feet - x4 Patins à rainures 071933

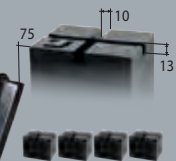

Pads for SUV - Patins pour SUV x4 065017



Wall mount - Support mural 071926



**NEW**

## AIR JACKS

MADE IN HIGH QUALITY ITALY



**AIR JACK VAN 2T**  
058330  
2T max



**AIR JACK CAR 2T**  
058323  
2T max

## MANUAL WHEEL LIFT

**Wheel lift trolley - Lève roue à treuil - Radmontage-Heber**  
061385

min : R13 / 135 / 65  
max : R22 / 300 / 35  
40 kg max

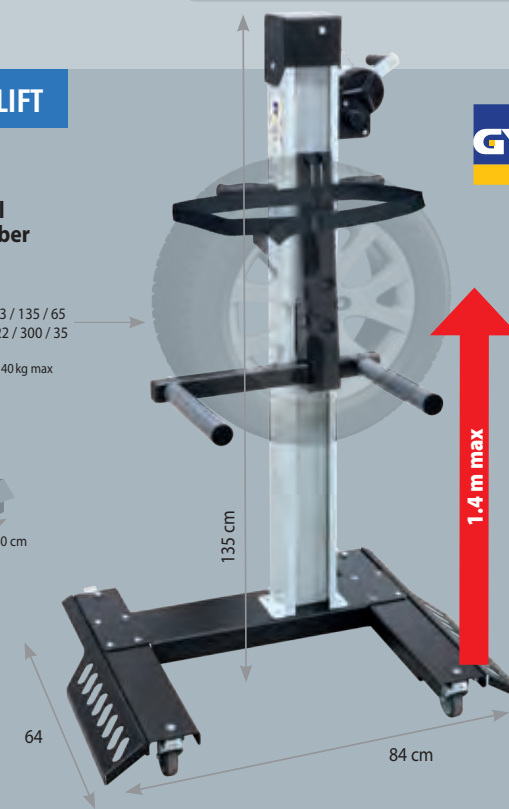

**jms PRO**

47

ERGO LIFT / AIR JACKS / MANUAL WHEEL LIFT

MOBILE LIFTS

**GYS**

1.4 m max





# SPOT WELDING

TECHNOLOGY 50

## INVERTER

TRAFO 53

TRAFO PREMIUM PRO 55

TRAFO GENIUS 57

G ARMS 58

ACCESSORIES & CONSUMABLES 59



# TECHNICAL IMPROVEMENTS

ÉVOLUTION TECHNOLOGIQUE - TECHNISCHE ENTWICKLUNG - MEJORAS TECNICAS

2004



### OLD SOLUTIONS

Traditional machines

180 daN max

6 500 A max

X clamps

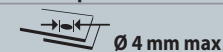

2023



### IMS SOLUTIONS

INVERTER Technology

550 daN max

14 500 A max

X & C clamps

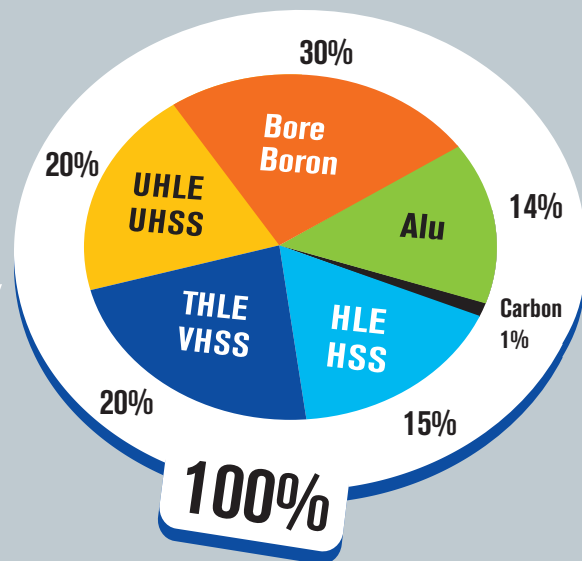
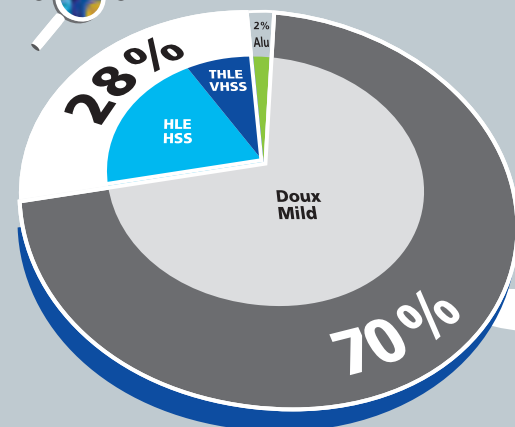
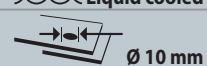
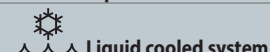

#### Facteurs d'évolution :

- Challenge CO2, faible poids
- Crash test ★★★★★
- Anti corrosion, nouveaux revêtements
- Esthétique et visibilité plus sophistiquées



#### Evolution factors :

- CO2 Challenge, low weight
- Crash test ★★★★★
- Anti-corrosion, new coatings
- Improved aesthetics and demand for better occupant visibility.



#### Entwicklungsfaktoren :

- CO2 Challenge, geringes Gewicht
- Crash-Test ★★★★★
- Anti-Korrosion, neue Beschichtung
- Modernes Technik-Design



#### Fattori di evoluzione :

- Sfida CO2, basso peso
- Crash test ★★★★★
- Nuovi rivestimenti, anticorrosivi
- Estetica e visibilità più sofisticate

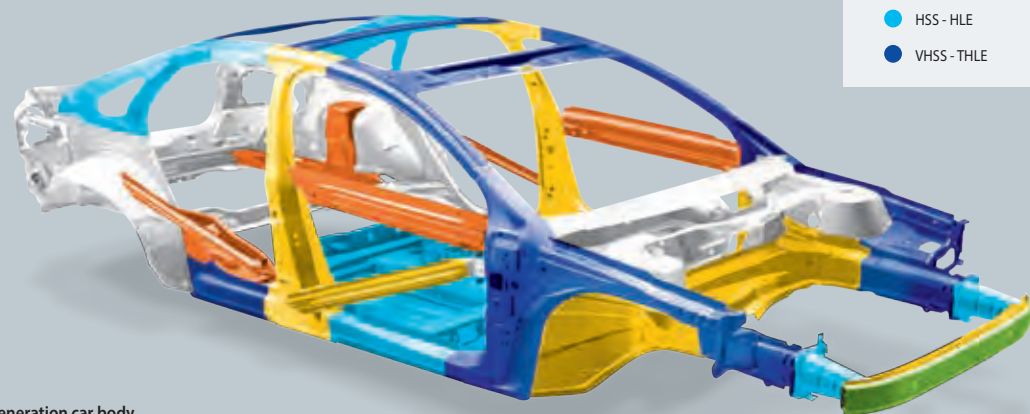
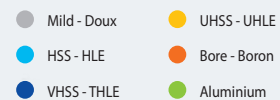

An example of new generation car body  
 • Exemple de carrosserie nouvelle génération  
 • Beispiel einer Karosserie der neuen Generation  
 • Esempio di carrozzeria di nuova generazione

# SPOT WELDING RANGE

## INVERTER



14 500 A

TRAFO



14 500 A

TRAFO PREMIUM PRO



14 500 A

TRAFO GENIUS

MILD - DOUX		•	•	•
HSS/VHSS - HLE/THLE		•	•	•
UHSS/BORON - UHLE/BORE		•	•	•
NUMBER OF SPOTS - NOMBRE DE POINTS 10 SPOTS/MIN	0,8 + 0,8 mm	no limit	no limit	no limit
	2,5 + 2,5 mm	60	60	> 200
INVERTER TECHNOLOGY		•	•	•
EMF DIRECTIVE 2013/35/UE		•	•	•
COOLING SYSTEM - SYSTÈME DE REFOUILLISSEMENT		<b>LIQUID</b>	<b>LIQUID</b>	<b>LIQUID</b>
AUTOMATED REGULATION - RÉGULATION AUTOMATIQUE	I (A)	•	•	•
	daN	•	•	•
		constant	constant	constant
<b>MODE AUTO</b>		•	•	•
PINCE - CLAMP	C	•	—	—
	G	—	•	•
Transformer Inside Clamp		•	•	•
Cables (L)		4 or 6 m	6 m	6 m
Includes gun		option	option	option
Max welding frequency (spots/min) - Cadence de soudage maximale (points/min)	0,8 + 0,8 mm	10	10	20
	2,5 + 2,5 mm	10	10	20
Fuse	400 V	20 A	25A	25 A
	200/208-240 V	40 A	40A	50 A



**ONLY FOR SPOT INVERTER TRAF0**

C Arms - Caps Ø13 mm

- Classic arms
- Isolated arms - Bras isolés - Isolierte Bügel

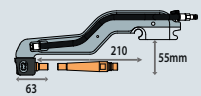

**C2 8 bar/550 daN**  
022386

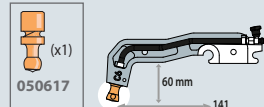

**C6 8 bar/300 daN**  
022409

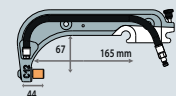

**C12 8 bar/550 daN**  
022997

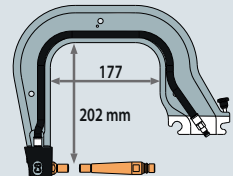

**C8 8 bar/550 daN**  
021440

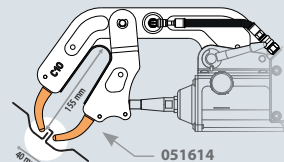

**C10 4 bar/150 daN**  
051638

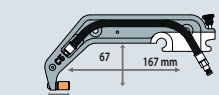

**C5 8 bar/550 daN**  
022393

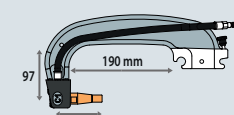

**C1 8 bar/550 daN**  
021402

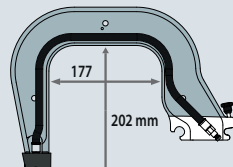

**C3 8 bar/550 daN**  
021419

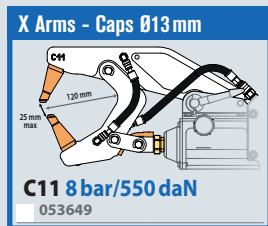

**C11 8 bar/550 daN**  
053649

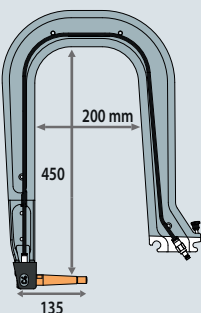

**C4 8 bar/550 daN**  
021426

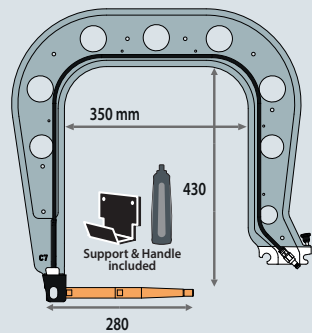

**C7 8 bar/550 daN**  
021433

Option for C7



**C7-SA (Small Access)**  
067684

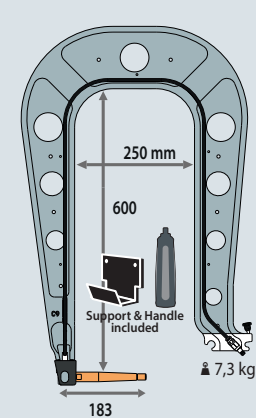

**C9 8 bar/550 daN**  
020078

Option for C9 & C14

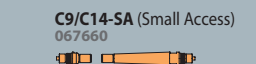

**C9/C14-SA (Small Access)**  
067660

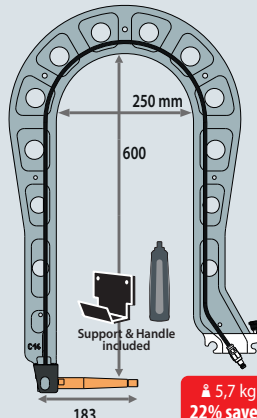

**C14 8 bar/400 daN**  
023543

5,7 kg  
22% saved

**C ARMS PANELS**

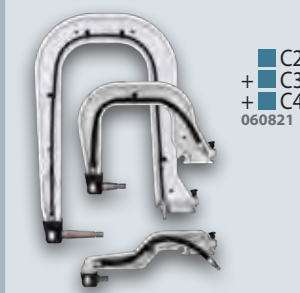

C2  
+ C3  
+ C4  
060821



C2  
+ C3  
+ C6  
+ C12  
+ C9  
061316



C10  
+ C3  
+ C5  
+ C6  
+ C9  
076495



Arm lock pin  
062405

Arm support kit  
077577

**NEW**

**SPOT INVERTER TRAF0**

**14 500 A**  
550 daN

For mild steel, HSS, UHSS Boron steel



**TRANSFORMER INSIDE**

Liquid cooled

**Automatic C clamp**  
Energy Dynamic Control

Traceability software  
Save spot welding configuration and export data

021327

	4M 021327
	6M 021310
<b>400V</b>	
SPOT INVERTER TRAF0	
Contact grease 050440	▪
Caps remover 050846	▪
Arm panel	▪
C1 021402	▪



**XL Cable Support**

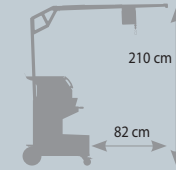
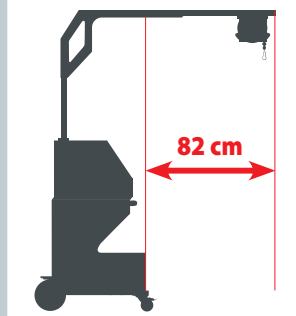

**NEW DESIGN**



Very light  
**9,9 kg**

**CONVERT TRAF0 > TRAF0 PREMIUM PRO WITH G ARMS**

KIT RENOV TRAF0 PREMIUM PRO  
220V 072367



400V 072541

C ARMS → G ARMS

**OPTIONS**



Complete gun kit 067318

GYRO 360° for TRAF0 051720

MADE IN FRANCE 62135	50/60 Hz	20 (14 kVA)	Spots/min (max) 2.5+2.5	RMS A	Uo V	mm			Cables		100% CU	cm	kg	
						2.5+2.5	1.5+3	4 m, liquid	6 m, liquid					
<b>SPOT TRAF0 400V</b>	3 x 400V	20 (14 kVA)	10	14 500	7.3	2.5+2.5+2.5	1.5+3	4 m, liquid	6 m, liquid	OPTION 067318: 1.6 m, Ø 200 mm²	8 m, 4x4 H07RN-F	OK	65 x 80 x 230	92





**G ARMS**  
p.58



MADE IN FRANCE

**FULL ERGONOMIC**  
10.3 kg  
(Gyro & G1 included)



550 daN

LIQUID COOLED  
REFROIDISSEMENT  
LIQUIDE  
Ø 10 mm

10.3 kg  
(Gyro & G1 included)

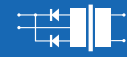

**TRANSFORMER INSIDE**

**GYRO INCLUDED**



**PERFECT ELECTRICAL CONNECTION**

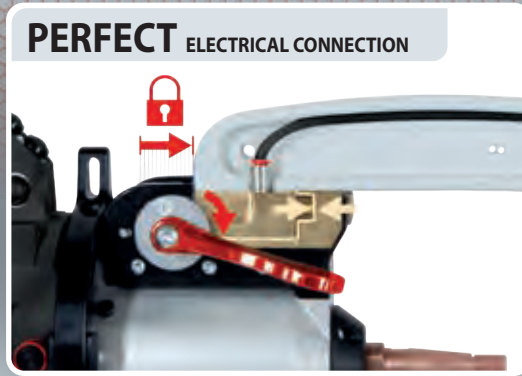

**AUTO**

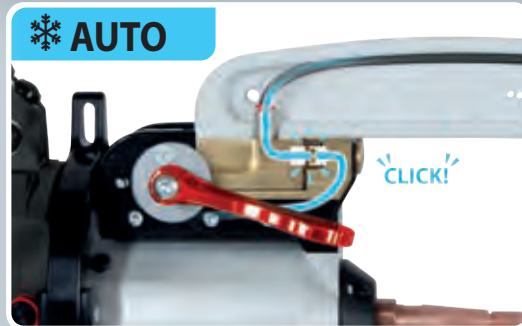

**XL Cable Support**

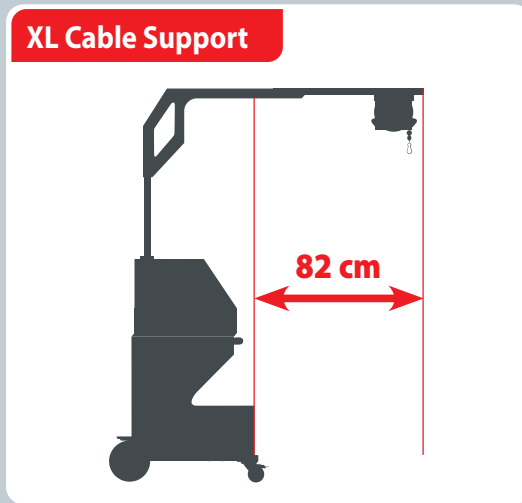

**Ergonomy & Security**

20°  
**EASY HANDLE**

**LOCKING SYSTEM**



**OPTIONS**

	Caps type A box 048935	x40 (x6: 049987)	x20 (x6: 049987)	073449
	Caps type F box 077119	x40 (x6: 049970)	x6 (x6: 049970)	
		x2 (x1: 050617)	x2 (x1: 050617)	



Cooling liquid - Liquide de refroidissement - Kühlmittel - Enfriamiento líquido - Refrigeração líquida  
10L  
052246



**SPOT INVERTER TRAFO PREMIUM PRO**

14 500 A  
550 daN

For mild steel, HSS, UHSS Boron steel

— FUSE — 20 A  
Double pressure  
Ø 10 mm  
10.3 kg (included G1)

**TRANSFORMER INSIDE**

Liquid cooled

**Automatic G clamp**  
Energy Dynamic Control

Traceability software  
Save spot welding configuration and export data

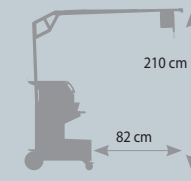

10.3 kg

	6M 072879 072893	220V 400V
Caps remover 050846		
Arm panel 022768		



**OPTIONS**

**NEW**

**G11**  
for TRAFO PREMIUM PRO only  
071766

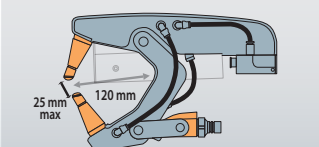

Kit gun TRAFO-G  
067226

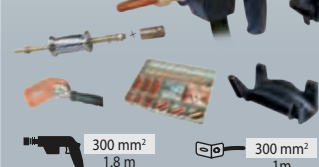

MADE IN FRANCE 62135	50/60 Hz	A D curve	Spots/min (max) 2.5+2.5	RMS A	Uo V	mm			Cables		100 % CU	cm	kg	
						↕	↔	↕	↔	↕				↔
<b>SPOT TRAFO PREMIUM PRO 220V</b>	3 x 200 208 220 240	30 (10-12 kVA) 40 (14-16 kVA) 50 (17-21 kVA)	10	12 500 13 000 14 500 14 500	6.6 6.9 7.3 7.9	2.5+2.5+2.5	1.5 + 3	↕	↔	OPTION 065226: 1.6 m, Ø 200 mm <sup>2</sup>	8 m, 4x4 H07RN-F	OK	65 x 100 x 230	92
<b>SPOT TRAFO PREMIUM PRO 400V</b>	3 x 400V	25 (14 kVA)	10	14 500	7.3	2.5+2.5+2.5	1.5 + 3	↕	↔	OPTION 065226: 1.6 m, Ø 200 mm <sup>2</sup>	8 m, 4x4 H07RN-F	OK	65 x 100 x 230	92



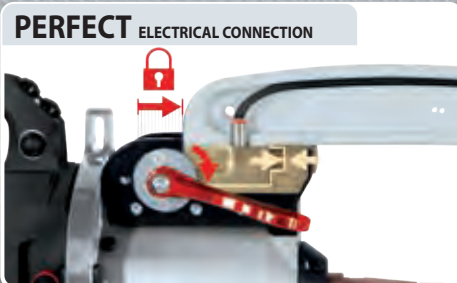
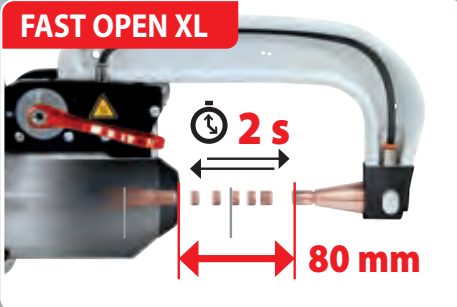

MADE IN FRANCE

550 daN

LIQUID COOLED  
REFROIDISSEMENT  
LIQUIDE

Ø 10 mm

11.3 kg  
(Gyro & G1 included)

**TRANSFORMER  
INSIDE**

**G**  
ARMS  
p.58

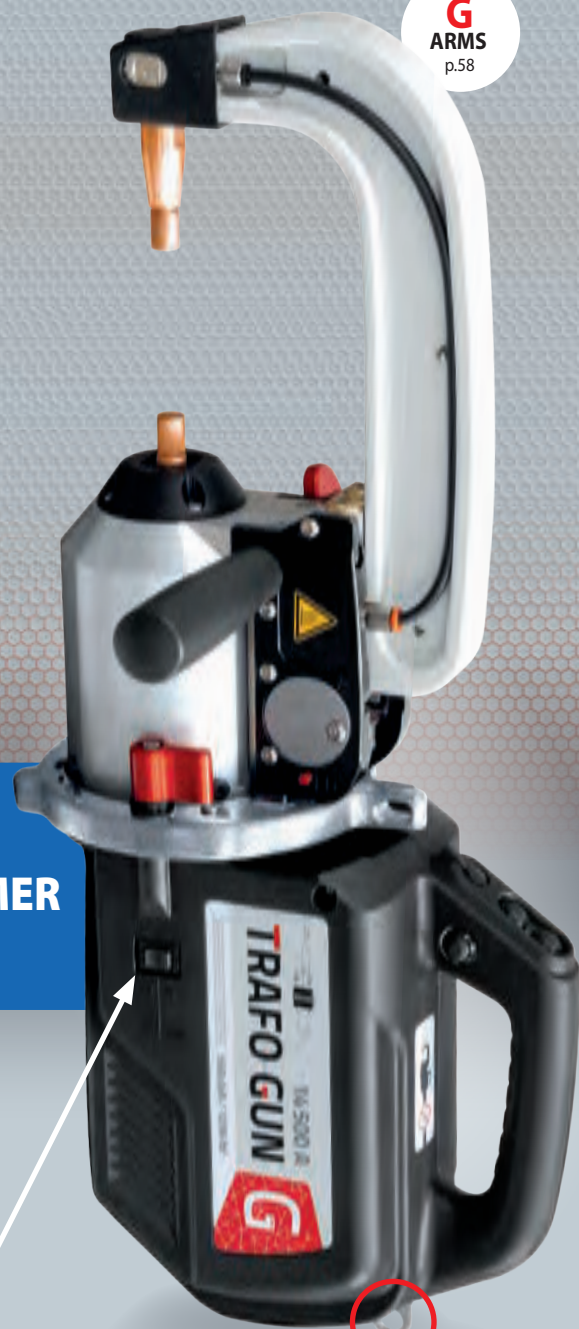

**Motorised cable support**  
- Potence électrique  
- Elektrisch verstellbarer  
Kabelsupport

**NEW DESIGN**

With control  
command  
- Avec contrôle  
de commande



DOWN  
159 cm



UP  
253 cm



UPSIDE DOWN  
POSITION

**OPTIONS**

Caps type A box  
048935 x40  
(x6: 049987)

Caps type F box  
077119 x40  
(x6: 049970)

x20  
(x6: 049987)

x6  
(x6: 049970)

x2  
(x1: 050617)

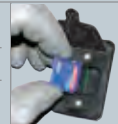

SD CARD  
050914

Kit WIFI  
Compatibility:  
Spot Inverter  
TRAFU GENIUS



Cooling liquid - Liquide de  
refroidissement - Kühlmittel  
- Enfriamiento líquido -  
Refrigeração líquida



**SPOT INVERTER  
TRAFU GENIUS**

**14 500 A**  
550 daN

For mild steel, HSS, UHSS Boron steel

**TRANSFORMER INSIDE**

Traceability software  
Save spot welding configuration  
and export data



	028708	028722	028746
SPOT INVERTER TRAFU GENIUS	220V	400V	480V
Caps remover 050846	■	■	■
Arm support	■	■	■
G1 022768	■	■	■

**Ergonomic**

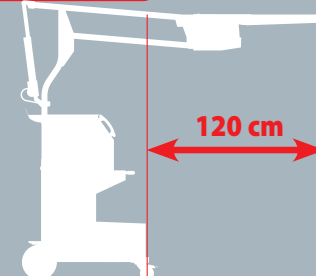

Included  
Cable support  
ULTRA  
RESISTANT



**ELECTRIC  
MOTOR**

Control  
Command

Electrode storage  
- Rangement pour  
électrodes

6 m

High stability -  
Grande stabilité

**OPTIONS**

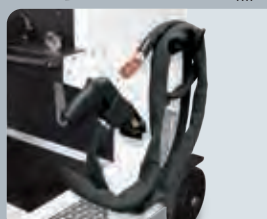

MADE IN FRANCE 62135	50/60 Hz	-AM- A D curve	Spots/min (max) 2.5+2.5	I RMS A	Uo V	mm		Cables		cm	kg
						↕	↔	↕	↔		
<b>SPOT TRAFU GENIUS 220 V</b>	3 x 200 208 220 240	50 (17-21 kVA)	20	12 500 13 000 14 500 14 500	6.6 6.9 7.3 7.9	2.5+2.5+2.5	1,5+3	6 m, Liquid	8 m 4xAWG8 (500W)	71 x 90 x 200	100
<b>SPOT TRAFU GENIUS 400V</b>	3 x 400V	25 (17 kVA)	20	14 500	7	2.5+2.5+2.5	1,5+3	6 m, Liquid	8 m 4x4 mm <sup>2</sup> HOTRNF	71 x 90 x 200	100
<b>SPOT TRAFU GENIUS 480V</b>	3 x 480V	20 (17 kVA)	20	14 500	7	2.5+2.5+2.5	1,5+3	6 m, Liquid	8 m 4xAWG12 (500W)	71 x 90 x 200	100



**FOR SPOT INVERTER TRAF0 PREMIUM PRO & TRAF0 GENIUS**

G Arms - Caps Ø13 mm

**Isolated arms - Bras isolés - Isolierte Bügel**

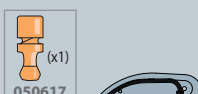

**G2**  
8 bar/300 daN  
022775



**G6**  
8 bar/550 daN  
022812

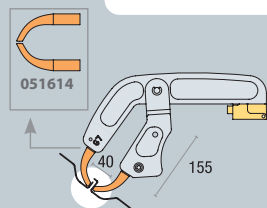

**G7**  
4 bar/150 daN  
022829

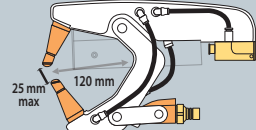

**G11**  
8 bar/550 daN  
for TRAF0 PREMIUM PRO only  
071766

Connectors maintenance kit for G clamp - Kit de maintenance connecteurs pince G 067295

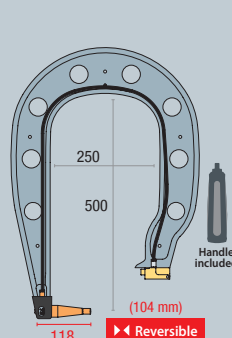

**G4**  
8 bar/550 daN  
022799

Option for G4

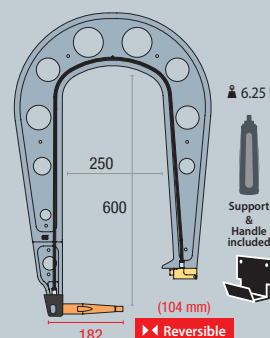
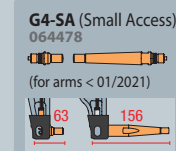

**G5**  
8 bar/550 daN  
022805

Option for G5

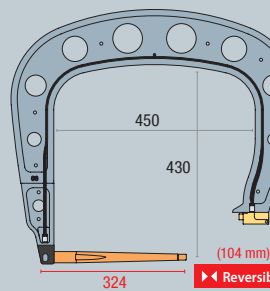
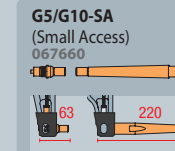

**G8**  
8 bar/550 daN  
022836

Option for G8

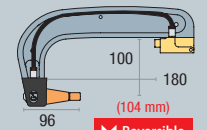
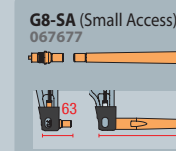

**G1**  
8 bar/550 daN  
022768

Option for G1 & G3

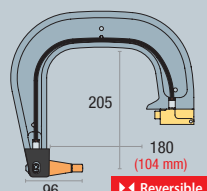

**G3**  
8 bar/550 daN  
022782

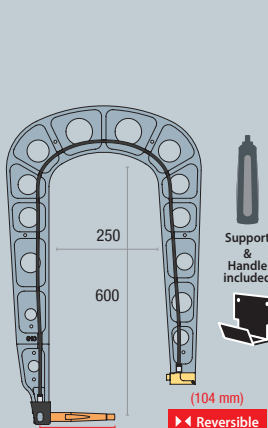
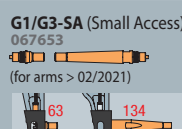

**G10**  
8 bar/400 daN  
067165

Option for G10 & G12

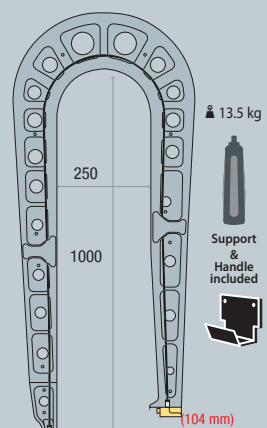

**G12**  
8 bar/300 daN  
075238



**G > X** PATENTED BREVETÉ PATENTED  
**UNIQUE SYSTEM** **AUTOMATIC WELDING**  
FOR X1, X2 & X6

**G9 | 8 bar/550 daN**  
not for TRAF0 PREMIUM PRO

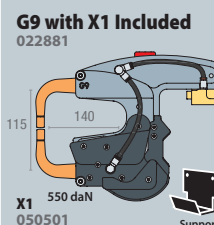

**G9 with X6 Included**  
072275

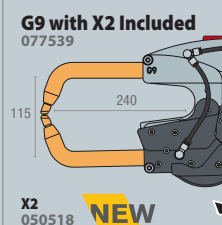
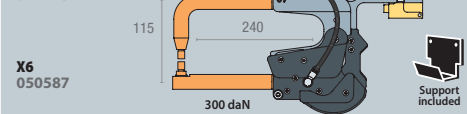

**G9 with X2 Included**  
077539

**G ARMS PANELS**

- G2 + G3 + G4 022898
- G2 + G3 + G5 063297

**KIT SMALL ACCESS GENIUS** for TRAF0 GENIUS 077072

- included: G1/G3-SA (Small Access) 134, G5/G10/G12-SA (Small Access) 220, G4-SA (Small Access) 156, G8-SA (Small Access) 368



**ACCESSORIES & CONSUMABLES**

**X/C/G CONSUMABLES - Consommables X/C/G**

Type A Cor X clamp Ø 13 mm (x6) 049987	Type D Cor X clamp Ø 13 mm (x10) 058507	TYPE G Ø 13 mm (x10) 059672	Caps type A box 048935 x40 (x6: 049987)	073449 x20 (x6: 049987) x6 (x6: 049970) x2 (x1: 050617)
Type B Cor X clamp Ø 13 mm / Ø 5 mm (x6) 055506	TYPE F For single sided gun Ø 13 mm (x6) 049970	Caps inclinés - Beveled X2, X4, C11 arms Ø 13 mm (x6) 049994	Caps type F box 077119 x40 (x6: 049970)	050068 x10 (x20: 052239) x6 (x6: 049994) x18 (x6: 049987) x18 (x6: 049970)
Contact grease - Graisse contact 050440	Caps remover 050846	NEW Anti-corrosion welding primer - Primaire de soudage anti-corrosion 076822	Spot / Monopoint 049291	

**CAP GRINDER - Affuteur de caps**

Blade - Lame 052857

048966

Optimal speed: 400-800 rpm

**GYRO 360°**

for EVOLUTION 051737

10-14 kg

for TRAF0 051720

**STEEL SHEET TRACTION BENCH**

- Banc de traction arrache tôle - Blech-Zugbank zur Festigkeitsprüfung

052420

052321 (included)

**WELD TEST KIT - Valise test soudure HLE / THLE**

- Schweißtestkit im Hartschalenkoffer

050433

Traction bar / Barre d'arrachage  
+ Mild steel / Acier doux 0.65 (x25) + 1.0 (x25)  
+ Steel / Acier HSLA 360 - HLE 0.8 (x25) + 1.5 (x25)  
+ Steel / Acier DP600 - THLE/UHLE 1.0 (x25)  
+ Steel / Acier FB560 - THLE/UHLE 2.5 (x25)

**ELECTRODE FORCE SENSOR - Capteur d'effort**

052314

**ANTI-ARC PROTECTION 12V**

- Protection anti-arc 12 V - Lichtbogenschutz 12 V  
- Protección anti-arco 12V

041318

**SHEETS SET**

- Echantillons de tôles

Standard steel / Acier standard  
0.8 (x65) + 1 (x55) + 1.5 (x35) + 2 (x25)  
+ Alu  
1 (x45) + 1.5 (x30) + 2 (x20)

055841

**TANK DRAINING KIT - Kit de purge réservoir**

- Kit zur Tankentleerung

058286

for TRAF0

**SD MEMORY CARD**

- Carte mémoire SD

SD CARD 050914

**KIT WIFI**

for Spot Inverter TRAF0 GENIUS

070691

**COOLING LIQUID - Liquide de refroidissement**

- Kühlmittel - Enfriamiento líquido - Refrigeração líquida

052246

10L





# RIVETING

GYSPRESS	62
GYSPRESS CONTROL	66
ADAPTERS	68
DIES BOXES & RIVETS	70
ACCESSORIES	73





GYPRESS

# RIVETING

PNEUMATIC HYDRAULIC

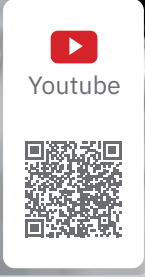

## BRAS DE RIVETAGE - RIVETING ARMS - STANZNIETBÜGEL



	HR110 063310	HR210 063327	HR310 8T PP/10T/10T PP 063334
GYPRESS 8T	✓	✓	—
GYPRESS 10T	✓	✓	✓
GYPRESS 8T PUSH PULL	✓	✓	✓
GYPRESS PREMIUM 10T PUSH PULL	✓	✓	✓
GYPRESS 10T PUSH PULL	✓	✓	✓
GYPRESS 10T CONNECT	✓	✓	✓



**KIT WITH HR210 + HR310**  
064089

**CASE & FOAM WITHOUT ARMS**  
- Valise et mousses sans bras  
077546

**XT31-40**  
HR310 arm extension for middle point  
- Rallonges bras HR310 pour point millieu

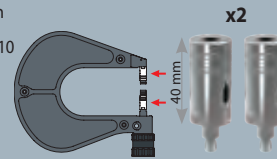

Compatible 8T PP/10T/10T PP  
x2  
066335

## OPTIONS

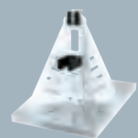

Riveting machine support for changing accessories (arms & dies)  
- Support Riveteuse pour changements d'accessoires (bras & matrice)  
- Supportständer  
↳ 28 x 40 x 21,5 cm  
054158

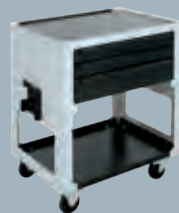

Trolley - Chariot  
↳ 74 x 51 x 81 cm  
↳ 80 x 15 x 123 cm  
44 kg  
054233



Trolley + Support Chariot + Support  
↳ 51 x 122 x 74 cm  
055391

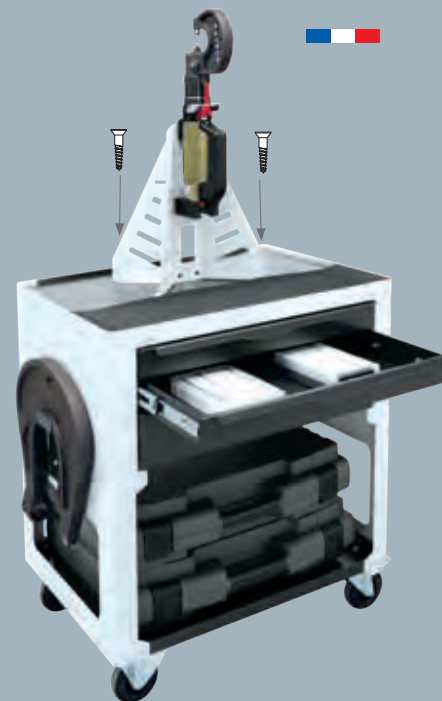

Pressure sensor  
- Capteur d'effort  
062115

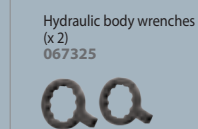

Hydraulic body wrenches (x2)  
067325

Temporary - Serre-tôles - fasteners manual mounting

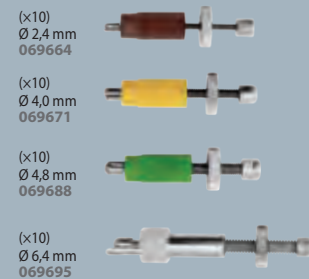

## GYPRESS 10T

6.5 bar | 100 kN

10t

063303



US version  
070653



Pressure gauge  
Psi > Kn



Discharge lever - Levier de décharge  
- Auslösehebel



Speed control - Contrôle de la vitesse - Regelung  
Werkzeuggeschwindigkeit



Pressure control - Contrôle de la pression  
- Druckregelung



## GYPRESS 10T COMPLETE PACKS

	HR110 063310	XT11.21 - Extension for HR110 & HR210 058644	Standard 10T tool box 053694	6 x 50 rivets RAP - Nieten SPR 048706	HR210 + HR310 064089	50kN adapter 064867	Pulling adapter kit 066076	Trolley+support 055391
<b>GYPRESS 10T</b> 063303 070653	✓							
<b>GYPRESS 10T pack 1</b> 066441			✓					
<b>GYPRESS 10T pack 2</b> 066458				✓				
<b>GYPRESS 10T pack 3</b> 064744								✓

MADE IN FRANCE	AIR BAR	PRESSURE CONTROL	SPEED CONTROL	↕	⬇️	↕	⬇️
	cm	kg	cm	kg	cm	kg	
<b>GYPRESS 10T</b>	6.5 bar = 10 t (maxi 10 bar)	0 > 6.5 bar	+	39.5 x 180	6.2 (HR110 included)	58 x 48 x 15	11.8



**GYPRESS 10T PUSH PULL**

6.5 bar 100 kN  
**10t**

063853

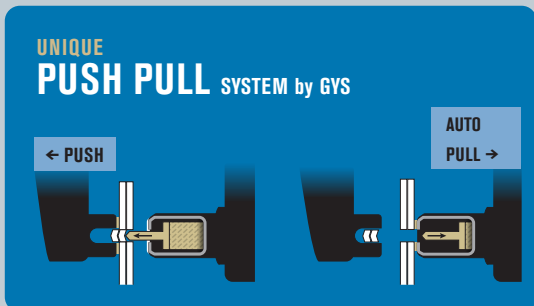
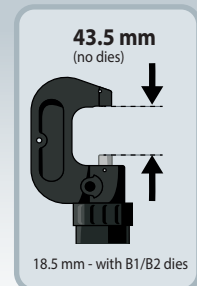

Push/Pull selection  
- Sélection Push/Pull



Pressure control  
- Contrôle de la pression  
- Druckregelung



Speed control  
- Contrôle de la vitesse  
- Regelung Werkzeuggeschwindigkeit

**HYDRAULIC SYSTEM**  
fermé - closed - geschlossen  
**UNIQUE 100%**  
**No air inclusion**  
maintenance free, no oil refill

**GYPRESS 10T PUSH PULL COMPLETE PACKS**

<b>GYPRESS 10T PUSH PULL</b> 063853	✓							
<b>GYPRESS 10T PP pack 1</b> 066465		✓						
<b>GYPRESS 10T PP pack 2</b> 066472			✓					
<b>GYPRESS 10T PP pack 3</b> 065789		✓						✓

	AIR BAR	PRESSURE CONTROL	SPEED CONTROL				
				cm	kg	cm	kg
<b>GYPRESS 10T PUSH PULL</b>	6.5 bar = 10 t (maxi 10 bar)	0 > 6.5 bar		39.5 x 180	6.7 (HR110 included)	58 x 48 x 15	12.5

**GYPRESS PREMIUM 10T PUSH PULL**

6.5 bar 100 kN  
**10t**

077065

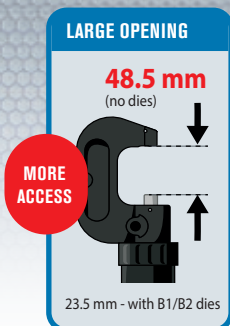

**MORE ACCESS**

23.5 mm - with B1/B2 dies



**HYDRAULIC SYSTEM**  
fermé - closed - geschlossen  
**UNIQUE 100%**  
**No air inclusion**  
maintenance free, no oil refill

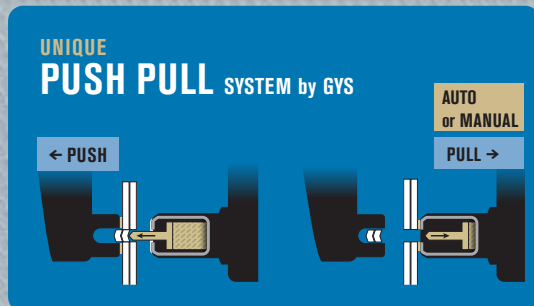

**ERGONOMIC WITH QUICK SELECTION**



**WORK FASTER**

Push/Pull selection  
- Sélection Push/Pull

**MANUAL PULL MODE**



Manual/Automatic selection  
- Sélection Manuel/Automatique

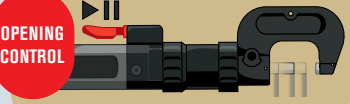

**OPENING CONTROL**



Pressure control  
- Contrôle de la pression  
- Druckregelung



Speed control  
- Contrôle de la vitesse  
- Regelung Werkzeuggeschwindigkeit

**GYPRESS 10T PREMIUM PUSH PULL COMPLETE PACK**

<b>GYPRESS PREMIUM 10T PUSH PULL</b> 077065							✓

	AIR BAR	PRESSURE CONTROL	SPEED CONTROL				
				cm	kg	cm	kg
<b>GYPRESS 10T PREMIUM PUSH PULL</b>	6.5 bar = 10 t (maxi 10 bar)	0 > 6.5 bar		39.5 x 180	6.7 (HR110 included)	58 x 48 x 15	?





# SYNERGIC RIVETING WORKSTATION

PNEUMATIC HYDRAULIC



**UNIQUE 100%**  
No air inclusion  
maintenance free, no oil refill

### ACCESSIBILITY

16 languages

- FR PR CN
- GB CZ JP
- DE NL VN
- IT SE FI
- ES RU TR

★★★★  
**SYNERGIC RIVETS SETTINGS**

Main panel

Setup instructions



Results



### 3 MODES

- MANUAL
- SYNERGIC
- CAR MANUFACTURERS

### CAR MANUFACTURERS COMPATIBILITY

- ✓ VW GROUP
- ✓ MERCEDES-BENZ
- ✓ BMW
- ✓ TESLA
- ✓ FERRARI
- ✓ FORD
- ✓ RENAULT ALPINE
- ✓ GM

### CONNECTIVITY

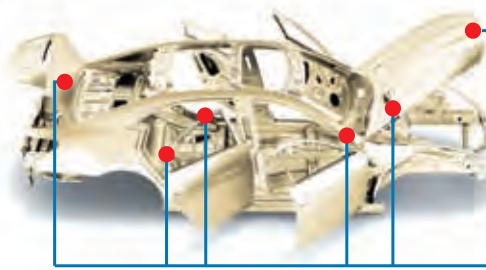

### TRACEABILITY

History data export

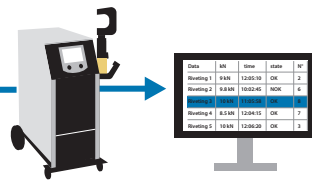

### SOFTWARE UPDATE

Gyspress evolutions

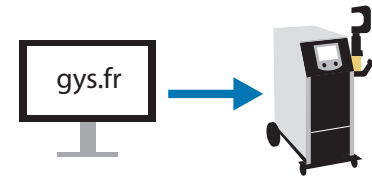

**UNIQUE PUSH PULL SYSTEM by GYS**

### PUSH PULL SYSTEM by GYS

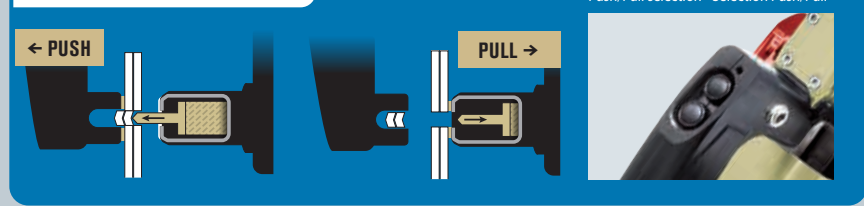

Push/Pull selection - Sélection Push/Pull

Gyspress support



Arms support



✓ **REGULATED PRESSURE CONTROL**

**POWER 10t**



Discharge lever - Levier de décharge - Auslösehebel

### WORKSTATION GYPRESS 10T PP CONTROL

6.5 bar | 100 kN  
**10t**

063860

included

- HR110 063310
- XT11.21 - Extension for HR110 & HR210 058644
- Standard 10T PushPull tool box 058361
- 6 x 50 rivets RAP - Nieten SPR 048706
- Strap-Sangle-Gurt
- HR arm locker
- Poignée-Handle-Griff

### OPTIONS

**Pressure gauge - Capteur d'effort**  
for Gyspress 10T PP CONTROL 071759



Youtube

**Hydraulic body wrenches**  
for GYPRESS 10T, 10T PushPull, 10T PP CONTROL (x2) 067325

MADE IN FRANCE <b>WORKSTATION GYPRESS 10T PP CONTROL</b>	230 V	AIR BAR 6.5 bar = 10 t (maxi 10 bar)	PRESSURE CONTROL 0 > 6.5 bar	SPEED CONTROL + -	cm	kg
					N/A	N/A (HR110 included)



**BLIND RIVET ADAPTERS - ADAPTATEURS POUR RIVETS AVEUGLES**

GYPRESS

Adaptators

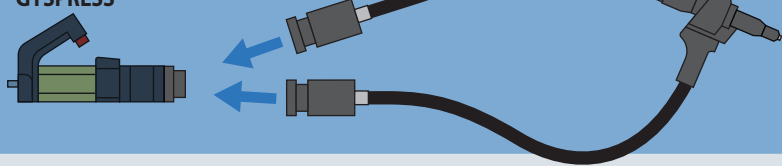

**Compatibility**

- GYPRESS 10T
- GYPRESS 10T PUSH PULL
- GYPRESS 10T PUSH PULL PREMIUM
- GYPRESS 10T CONNECT



**BLIND RIVET ADAPTER 24 kN - Adaptateur 24 kn pour rivets aveugles - Blindnietadapter 24 kN**

HIGH ACCESSIBILITY



SPECIFIC STORAGE



**24 kN STANDARD** 600 mm  
063822

For BLIND rivets - Pour rivets POP - Für Blindniet

Steel / Acier: Ø 4.0 → 6.4  
Alu: Ø 4.0 → 7.8

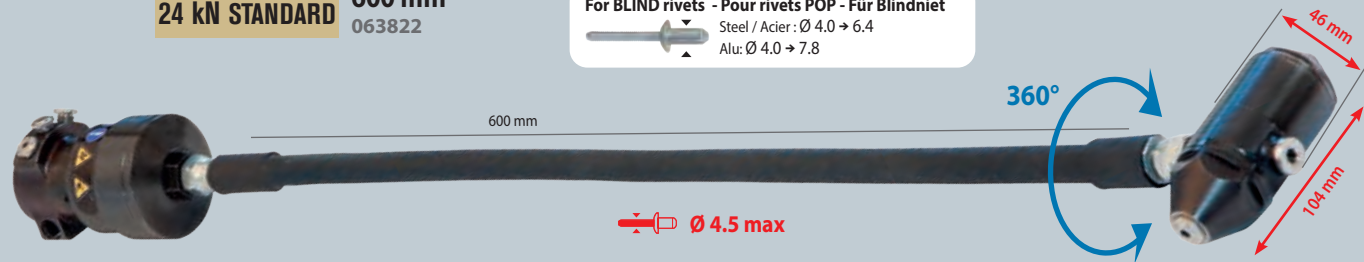

Ø 4.5 max

INCLUDED

- 058446
- for standard rivets: Ø 3.2 x1 059221, Ø 3.6 x1 059238
- Ø 4.0 x1 059245, Ø 4.5 x1 059252

**24 kN COMPACT** 600 mm  
077164

For BLIND rivets - Pour rivets POP - Für Blindniet

Steel / Acier: Ø 6.4  
Alu: Ø 6.4 → 7.8

COMPACT HEAD



NEW

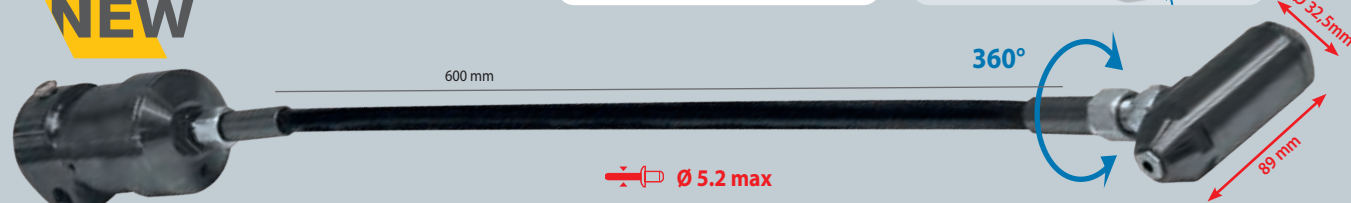

Ø 5.2 max

INCLUDED

- 058446
- for standard rivets: Ø 4.5 x1 059252, Ø 5.2 x1 079939
- for extraction of self piercing rivet: Rivet-extraction insert - Buse d'extraction 24kN compact Ø 5 079946

**PERFECT COMBO WITH ARCPULL - Spécial arrachage de rivets - Spezial-Zugnieten**



**OPTION FOR SPOT ARC PULL (details p.17)**

for SPOT ARCPULL 350

ARCPULL RIVET BOX1 350 - 24kN 064584					
Ø 4 x 50 mm 064607	- Canon pour pose de tige inox	- Support porte-goujon 059634	059641	Ø4mm 049000	Ø 4 064683
x100	x1	x1	x1	x1	x1

**BLIND RIVET ADAPTER 50 kN - Adaptateur 50 kn pour rivets aveugles - Blindnietadapter 50 kN**



Stroke adjustment - Réglage de la course de traction 0 → 25 mm

**50 kN** 1 m  
064867

▲ 4.0 kg

For BLIND rivets - Pour rivets POP - Für Blindniet  
Acier / Steel: Ø 4.0 → 6.4  
Alu: Ø 4.0 → 7.8

INCLUDED

Kit Standard



Complete kit 065987



OPTIONS

Acier / Steel: Ø 4.0 → 6.4  
Alu: Ø 4.0 → 7.8

160 mm extension - Extension 160 mm - Verlängerung 160 mm  
066144

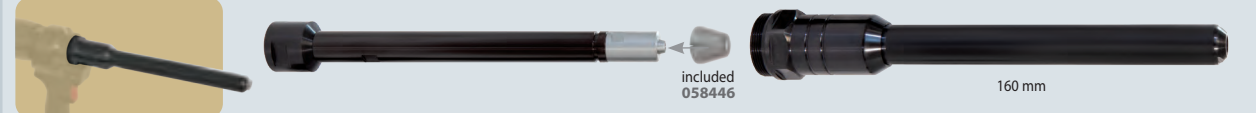

Ø 8.0 → 9.8

Ø8.0/9.8mm nozzle-piece kit - Kit Rivets Ø8.0/9.8mm - Mundstückkit 8,0/9,8 mm  
066045



M5 → M14  
M5 → M8

Blind rivet nut pulling, Blind rivet bolt adapter kit - Kit 6 tirants pour pose d'écrous à sertir et goujons à sertir - Blindnietmuttern, Blindnietgewindebolzen-Kit  
066076



**OPTION FOR SPOT ARCPULL (details p.17)**

for SPOT ARCPULL 350

ARCPULL RIVET BOX2 350 - 50kN 073388				
070745	070738	059634	059641	066151
x100	x1	x1	x1	x1

for SPOT ARCPULL 700

ARCPULL RIVET BOX 700 068452										
070745	070738	066151	071377	059641	059610	071384	071384	071384	071384	071384
x100	x1	x1	x1	x1	x2	x1	x1	x1	x1	x1

**CONSUMABLES BOX FOR 50KN ADAPTER - Boîte consommables pour adaptateur 50kN - Zubehörbox für 50 kN Adapter**

066168	Écrous à sertir - Blind rivet nuts						Goujons à sertir - Blind rivet bolts			Rivets aveugles - Blind rivets	
	M5	M6	M8	M10	M12	M14	M5	M6	M8	Ø 6.4	Ø 9.8
+ plaque de démonstration - demo metal sheet	22.5 → 27 mm	24 → 28.5 mm	23.5 → 28 mm	0.5 → 3.0 mm	0.5 → 3.0 mm	0.5 → 3.0 mm	2.8 → 4.8 mm	3.0 → 14.0 mm	x50 066267	x50 066274	
	x10	x10	x10	x10	x10	x5	x10	x10	x10	x10	x10



**Application of self-piercing rivets**  
- Pose de rivets auto-perçants  
- Stanzniet-Verpressen

**Application of solid rivets**  
- Pose de rivets pleins  
- Vollniet-Verpressen

**Application of Flow-form rivets**  
- Pose de rivets Flow-Form  
- Setzen v. Fließformnieten

**Extraction de rivets**  
- Extraction of rivets  
- Niet-Auspressen

**Metal sheet punching and shaping**  
- Perçage et formage des tôles pour rivets pleins  
- Vollniet-Lochstanzen/Prägen

**DIES BOXES - Boîtes matrices - Matrizensätze**

**STANDARD**

**STANDARD 8T/10T**  
for 8T 10T  
053694  
Included XT11-21 058644

x1	x1	x1	x1	x1	x1	x1	x2	x1	x1	x1	x1	x2	x4
A1	A2	B1	B2	F1	F2	D17	E1	E2	T1	T2			
Self-piercing rivets				Flow-form rivets			Extraction		Punching		key - clé	seals - joints	x1
Ø 3.2, 3.5	Ø 3.3	Ø 5, 5.3	Ø 5.3	Ø 6 - A1/2/3 S0/1/2/3/4/5/6			—	Ø 3.3, 4.8	Ø 3.9, 5.3	Ø 6			

**STANDARD 8T/10T PUSH PULL**  
for 8T PP 10T PP 10T CONTROL  
058361  
Included XT31-60 -60 mm extension for HR310 (use with ST1, T5, T7) 057135  
+ XT11-21 058644

x1	x1	x1	x1	x1	x1	x2	x1	x1	x1	x1	x2	x4	
A1	A2	B1	B2	F1	F2	D17	E1	E2	ST1	T5	T7		
Self-piercing rivets				Flow-form rivets			Extraction		Punching		key - clé	seals - joints	x1
Ø 3.2, 3.5	Ø 3.3	Ø 5, 5.3	Ø 5.3	Ø 6 - A1/2/3 S0/1/2/3/4/5/6			—	Ø 3.3, 4.8	Ø 3.9, 5.3	Ø 6			

**Do not use with Gyspress 8T & 8T PP - Ne pas utiliser avec une Gyspress 8T & 8T PP**

**Low pressure** Ø 6.4 mm  
**High pressure** Ø 6.4 mm  
**Flow-Form Ø 6 mm**  
**Flow-Form Ø 8 mm**

**KIT RMB PP05** for 10T PP 10T CONTROL  
Idéal aluminium, aciers doux - Ideal for aluminum, mild steel 066366  
x1 ST3, x1 T12, x1 T13  
Punching Ø 6.7

**KIT RMB 08 PREMIUM** for 10T 10T PP 10T CONTROL  
Idéal aciers durs, Boron - Ideal for UHSS, Boron 066403  
x1 T14, x1 T15, x1 T16  
Punching Ø 6.7

**KIT RMB 14 PREMIUM** for 10T 10T PP 10T CONTROL  
Idéal aciers durs, Boron - Ideal for UHSS, Boron 071186  
x1 T17, x1 T18, x1 T19  
Punching Ø 6

**KIT RMB 15 PREMIUM** for 10T 10T PP 10T CONTROL  
Idéal aciers durs, Boron - Ideal for UHSS, Boron 071193  
x1 T20, x1 T21, x1 T22  
Punching Ø 8

**GM**

**RMB 11** for 10T  
071087  
**RMB PP04** for 10T PP 10T CONTROL  
071063  
Included XT31-60 -60 mm extension for HR310

x1	x1	x1	x1	x1	x1	x1	x1	x1	x1	x1	x3	x1	x1	x2	x2	x4
F1	F2	F6	E9	E11	T1	T2	—	—	T7	T17	T18	T19	D18	D17		
Flow-form rivets			Extraction		Punching										key - clé	seals - joints
Ø 6			Ø 6.8		Ø 6											

**FERRARI**

**RMB 06** for 8T 10T 8T PP 10T PP 10T CONTROL  
059009

x1	x1	x1	x1	x1	x1	x1	x2	x1	x1	x1	x2	x4			
B4	B5	B6	S3	S7	S8	D17	E1	E2	E13						
Self-piercing rivets						Extraction		Punching				key - clé	seals - joints		
Ø 3.9		Ø 4.75		Ø 3.9		Ø 4.75		—		Ø 3.3, 4.8		Ø 3.9, 5.3		Ø 4.75	

**VW GROUP**

**RMB 03** for 8T 10T 8T PP 10T PP 10T CONTROL  
054257

x1	x1	x1	x1	x1	x1	x1	x1	x1	x1	x1	x1	x1	x1	x1	x1	x1	x1	x2	x4														
A1	B1	S3	S7	S8	D8	D9	D17	D1	D2	D3	D4	D13	E2	S1	S4	S5	D5	D6	D7	D10	D11	D12	D15	D16									
Self-piercing rivets				Solid rivets		Extraction										Punching				key - clé	seals - joints												
Ø 3.2, 3.5		Ø 5, 5.3		Ø 3.9		Ø 4.75		Ø 4		Ø 6		Ø 3.2		Ø 5.3		Ø 3.9, 5.3		Ø 3.2		Ø 5.3		Ø 8		Ø 4.8		Ø 4+8		Ø 4		Ø 8		Ø 6	

**NIO**

**RMB PP08** for 10T 10T PP 10T CONTROL  
072404  
Included XT31-60 -60 mm extension for HR310

x1	x1	x1	x1	x1	x1	x1	x1	x1	x1	x1	x1	x3	x1	x2	x1	x2	x4	
B1	B2	F1	F2	F6	E2	E3	E9	E11	T5	ST1	T7	T17	T18	T19	D17	D18		
Self-piercing rivets		Flow-form rivets			Extraction			Punching							key - clé	seals - joints		
Ø 5.3		Ø 5.3		Ø 6			Ø 5.3			Ø 6			Ø 6					

**MERCEDES-BENZ**

**RMB 07** for 10T  
064454  
Included XT31-60 -60 mm extension for HR3 (use with E3, E4, E5, E9, E10, E11) 057135

x1	x1	x1	x1	x1	x1	x1	x1	x1	x1	x1	x1	x1	x1	x1	x1	x1	x1	x2									
F1	F2	F3	F4	F5	—	—	—	E9	E10	E11	T1	T2	T3	T4													
Flow-form rivets					Extraction										Punching		key - clé										
Ø 6 - A1/2/3 S0/1/2/3/4/5/6					S28/38/48/58/68					S08/18		Ø 5.3, 8		Ø 6		Ø 8		Ø 6.8		Ø 8		Ø 6		Ø 6		Ø 8	

**RMB PP01** for 8T PP 10T PP 10T CONTROL  
058378  
Included XT31-60 -60 mm extension for HR3

x1	x1	x1	x1	x1	x1	x1	x1	x1	x1	x1	x1	x1	x1	x1	x1	x1	x2										
F1	F2	F3	F4	F5	—	—	E9	E10	E11	ST1	ST2	T5	T7	T8	T10												
Flow-form rivets					Extraction					Punching					key - clé												
Ø 6 - A1/2/3 S0/1/2/3/4/5/6					S28/38/48/58/68					S08/18		Ø 6.8		Ø 8		Ø 6		Ø 6		Ø 8		Ø 6		Ø 6		Ø 8	

**FORD**

**RMB PP02** for 10T 8T PP 10T PP 10T CONTROL  
058835  
Included XT31-60 -60 mm extension for HR3 (use with E7 & E12) 057135

x1	x1	x1	x1	x1	x1	x1	x1	x1	x1	x1	x1	x2	x4
B1	G1	G2	G3	G4	G5	G6	E7	E12					
Self-piercing rivets								Extraction		key - clé		seals - joints	
Ø 5, 5.3								Ø 5, 5.3					

**JAGUAR / LAND ROVER**

**RMB 02** for 8T 10T 8T PP 10T PP 10T CONTROL  
054271

x1	x1	x1	x1	x2	x1	x1	x2	x4					
B1	B2	B3	S8	D17	E1	E6							
Self-piercing rivets				Extraction		clé - key		seals - joints					
Ø 5, 5.3		Ø 5.3		Ø 4.8		Ø 4.75		—		Ø 3.3, 4.8		Ø 3.3, 4.8	

**BMW**

**RMB 01** for 8T 10T 8T PP 10T PP 10T CONTROL  
054240

x1	x1	x1	x1	x1	x1	x1	x2	x4			
A1	A2	B1	B2	E1	E2						
Self-piercing rivets					Extraction		key - clé		seals - joints		
Ø 3.2, 3.5		Ø 3.3		Ø 5, 5.3		Ø 5.3		Ø 3.3, 4.8		Ø 3.9, 5.3	

**RMB 12** for 10T  
071094  
**RMB PP07** for 10T PP 10T CONTROL  
071070  
Included XT31-60 -60 mm extension for HR310

x1	x1	x1	x1	x1	x1	x1	x1	x1	x1	x1	x1	x1	x1	x1	x1	x1	x1	x1	x1	x1	x3	x1	x1	x2	x2	x4
B1	B3	I1	I2	I3	F1	F2	F6	E3	E13	T1	T2	—	—	ST1	T5	T7	T17	T18	T19	D18	D17					
Self-piercing rivets					Flow-form rivets			Extraction		Punching										key - clé	seals - joints					
Ø 5, 5.3		Ø 5.3		Ø 4.8		Ø 4.75		—		Ø 3.3, 4.8		Ø 3.3, 4.8		Ø 9		Ø 6										

**PORSCHE**

**RMB 10** for 10T  
069299  
**RMB PP06** for 10T PP 10T CONTROL  
069305  
Included XT31-60 -60 mm extension for HR310

x1	x1	x1	x1	x1	x1	x1	x1	x1	x1	x1	x1	x1	x1	x1	x1	x1	x1	x1	x1	x1	x3	x1	x2	x2	x4
B3	F2	E9	E11	—	—	T5	ST1	T7	T17	T18	T19	D17													
Flow-form rivets			Extraction		Punching										key - clé	seals - joints									
Ø 6			Ø 6.8		Ø 6																				

**TESLA**

**RMB 09** for 8T 10T 8T PP 10T PP 10T CONTROL  
059931

x1	x1	x1	x1	x1	x1	x1	x1	x1	x1	x1	x1	x2	x4			
B1	H1	H2	H3	H4	H5	H6	H7	H8								
Self-piercing rivets													key - clé		seals - joints	
Ø 5, 5.3						Ø 5.3										

**RMB 13** for 10T  
071100  
**RMB PP03** for 8T PP 10T PP 10T CONTROL  
059092  
Included XT31-60 -60 mm extension for HR3 (use with E2, E3, E9, E10) 057135

x1	x1	x1	x1	x1	x1	x2	x1	x1	x1	x1	x1	x1	x1	x1	x1	x1	x1	x1	x1	x1	x1	x1	x2	x4
B1	S7	S8	F3	F4	F5	D17	E2	E3	E9	E10	—	—	—	—	T3	T4								
Self-piercing rivets				Flow-form rivets			Extraction					Punching				key - clé	seals - joints							
Ø 5, 5.3		Ø 4.75		S28/38/48/58/68			S08/18		—		Ø 3.9, 5.3		Ø 5.3, 8		Ø 6.8		Ø 8		Ø 8		Ø 8		Ø 8	



**DIES - Matrices - Matrizen**

Application of self-piercing rivets  
- Pose de rivets auto-perçants  
- Stanzniet-Verpressen

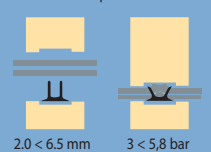

Application of solid rivets  
- Pose de rivets pleins  
- Vollniet-Verpressen

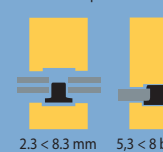

Pose de rivets Flow-Form  
- Application of Flow-form rivets  
- Setzen v. Fließformnieten

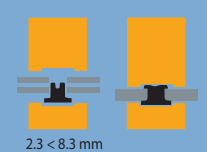

Extraction of rivets  
- Extraction de rivets  
- Niet-Auspressen

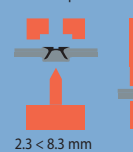

Metal sheet punching and shaping  
- Percage et formage des tôles pour rivets  
- Vollniet-Lochstanzen/Prägen

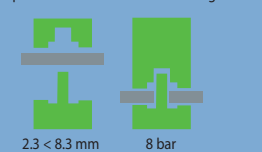

x1	x1	x1	x1	x1	x1	x1	x1	x1	x1	x1	x1	x1	x1	x1	x1	x1	x1	x1	x1	x1	
A1	A2	B1	B2	B3	B4	B5	B6	D1	D2	D3	D4	D5	D6	D7	D8	D9	D10	D11	D12	D13	
055698	055704	055711	055728	055735	059016	059023	059030	055971	055988	055995	055742	056008	056015	056022	056039	056046	055674	056060	056053	055759	
A1+A2		B1+B2																			
054295		054301																			

x1	x1	x1	x1	x1	x5	x1	x1	x1	x1	x1	x1	x1	x1	x1	x1	x1	x1		
D15	D16	D17	D18	E1	E2	E3	E6	E7	E9	E10	E11	E12	E13	F1	F2	F3	F4		
056077	056084	055681	071155	055865	054288	055766	057005	057142	057159	058606	058613	058620	058828	059085	055773	055780	055797	055803	
				E1+E2												F1+F2			
				054318												054714			

x1	x1	x1	x1	x1	x1	x1	x1	x1	x1	x1	x1	x1	x1	x1	x1	x1	x1	x1
F5	F6	G1	G2	G3	G4	G5	G6	H1	H2	H3	H4	H5	H6	H7	H8	I1	I2	I3
055810	071148	057173	057180	057197	057203	057210	057227	068230	068247	068254	068261	068278	068285	068292	068308	071117	071124	071131

x1	x1	x1	x1	x1	x1	x1	x1	x1	x1	x5	x1	x1	x1	x1	x1	x1	x1	x1	
S1	S3	S4	S5	S7	S8	ST1	ST2	ST3	T1	T2	T3	T4	T5	T7	T8	T10	T12	T13	
057036	057043	057050	057067	057074	057081	058071	058088	066397	057098	059078	057104	055827	055834	058019	058033	058040	058064	066373	066380
									T1+T2										
									054707										

**PATENTED GYS PATENT BREVET GYS**

x1	x1	x5	x1	x1	x1	x5	x1	x1			
T14	T15	T16	T17	T18	T19	T20	T21	T22			
066410	066427	068964	066434	069312	069329	071254	069336	070936	070943	071261	070950

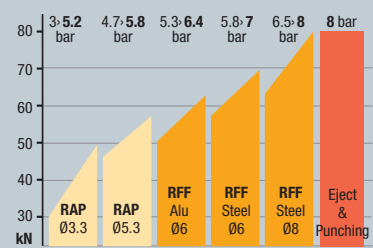

**SELF PIERCING RIVETS (SPR)**  
- Rivets auto-perçants (RAP) - Stanznieten

Steel - Acier - Stahl

Complete box  
048706

x200	x200	x100	x100	x100	x100	x100	x100
048232	048249	048256	048263	048270	048225	048638	048645

**SPECIAL CENTER PUNCH**  
- Pointeau centreur  
- Spezialekörner

048379



**HYDROPNEUMATIC TOOL FOR BLIND RIVETS**  
- Riveteuse hydro-pneumatique - Hydro-pneum. Blindnietgerät

**HR9**

For BLIND rivets - Pour rivets POP - Für Blindniet  
Acier / Steel Ø 3.2/4.0/4.8  
Alu Ø 3.2/4.0/4.8

max 9 000 N

057234

Made in Taiwan



**HYDROPNEUMATIC TOOL FOR BLIND RIVETS**  
- Riveteuse hydro-pneumatique - Hydro-pneum. Blindnietgerät

**HR14**

For BLIND rivets - Pour rivets POP - Für Blindniet  
Steel / Acier Ø 4.0/4.8/6.4  
Alu Ø 4.0/4.8/6.4

max 14 000 N

057241

Made in Taiwan



**CORDLESS RIVETER**  
- Riveteuse sur batterie - Akku-Blindnietgerät

**TWO ER20** 064461

For BLIND rivets - Pour rivets POP - Für Blindniet  
Ø 4.0/4.8/5.0/6.0/6.4

max 20 000 N (6 bar)  
10-20 V universal fast charger (30 min)  
2.0 kg



2 x  
20V/2Ah Li-ion battery



**MANUAL TOOL FOR BLIND RIVETS**  
- Riveteuse manuelle - Manueller Blindnietgerät

For BLIND rivets - Pour rivets POP - Für Blindniet

Steel / Acier Ø 3.2/4.0/4.8/6./6.4  
Alu Ø 3.2/4.0/4.8/6./6.4

061323



Made in Taiwan

**HYDROPNEUMATIC TOOL FOR RIVET NUTS** - Sertisseuse hydro-pneumatique riv 998 - Hydro-pneum. Blindnietmuttergerät

**RIV 998**

Sealing nuts - Ecrous à sertir - Blindnietmutter

For sealing nuts from M3 to M12  
Pour la pose d'écrous à sertir M3 à M12

max 19 000 N (6 bar)  
included accessories for sealing nuts:  
- livré avec accessoires pour écrous à sertir:  
✓ M3  
✓ M4  
✓ M5  
✓ M6  
✓ M8  
✓ M10  
✓ M12

055414



MADE IN ITALY

**HYDROPNEUMATIC TOOL FOR BLIND RIVETS**  
- Riveteuse hydro-pneumatique - Hydro-pneum. Blindnietgerät

**HR21**

For BLIND rivets - Pour rivets POP - Für Blindniet  
Ø 4.0 → 7.8

max 21 000 N (6 bar)

055407



included (x3)  
058446

For standard rivets  
Ø 4.0  
51508

For Magnarive rivets  
Ø 4.5  
51507



MADE IN ITALY

Option HR21 extension  
100 mm  
063105





# MIG-MAG

## GMAW-FCAW

### TRADITIONAL

CARPRO	76
--------	----

### INVERTER

GOLD MULTI	77
------------	----

MIG CARPRO	78
------------	----

CARPULSE	80
----------	----

ACCESSORIES & CONSUMABLES	84
---------------------------	----

WELDING HELMETS	86
-----------------	----

FUME EXTRACTION	91
-----------------	----



# MIG/MAG TRADITIONAL SYNERGIC

**15 → 200 A**  
Ideal 0,6 mm



**SYNERGIC - EASY TO USE**  
Auto adaptative wire speed / Réglage automatique de la vitesse  
Automatische Einstellung der Drahtgeschwindigkeit

MIG CARPRO 230V

**15 → 160 A**

Capacitor

6 m

230V • 1~  
014688

Capacitor

> PERFECT WELD

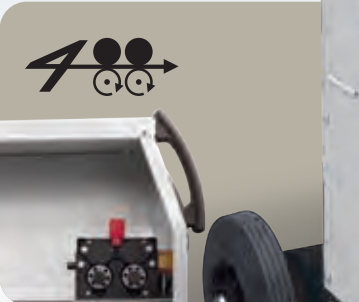
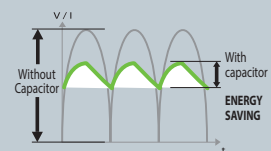

ACCESSORIES BOX



# MIG/MAG INVERTER SYNERGIC

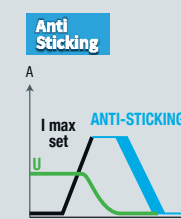
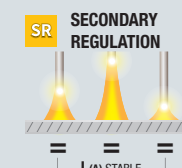
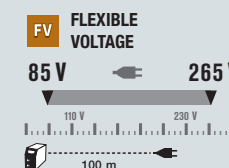
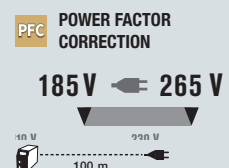

POWER FACTOR CORRECTION  
**PFC**  
EN 61000-3-12  
FLEXIBLE VOLTAGE  
**FV**



GOLD MULTI AUTO

**200 A**

∅ 200/300

4-wire

2 m

P400 PFC FV SR Anti Sticking  
GAS NO GAS MMA TIG

3 m 2,5 m, 16 mm<sup>2</sup> 2 m, 16 mm<sup>2</sup>  
075870

OPTIONS

**Spool Gun Torch for MIG Carpro 230V**  
- Torche motorisée Spool Gun  
- Spool Gun Brenner



041486

∅ 100  
Ideal for  
- Steel / Acier / Stahl  
- Stainless steel / Inox  
- Alu

4 m  
included  
045699



15L/min  
(FR) 041998  
(UK) 040274  
(NL) 040267  
(IT) 038691

OPTIMAPRO  
30L/min  
(FR) 043619  
(UK) 043626  
(DE) 043633  
(NL) 043640

30L/min  
(FR) 041622  
(UK) 041646  
(DE) 041219  
(NL) 041615  
(IT) 038707

**MB 15 (150 A)**  
041226

x3 x5 x3  
x5 (M6-∅0,6)  
x5 (M6-∅0,8)  
x5 (Alu - M6-∅0,8)



041332

041806

Sheets set  
- Echantillons de tôles

Standard steel / Acier standard  
0,8 (x65) + 1 (x55)  
+ 1,5 (x35) + 2 (x25)  
+ Alu  
1 (x45)  
+ 1,5 (x30)  
+ 2 (x20)

055841

Steel / Acier, 3 m  
063754

MADE IN FRANCE	MADE IN GYS CHINA	60974/1	50/60 Hz	A	min → max	Reg	∅ mm	100 (spoolgun) 200 300	Electronic Control	EN60974-1 (40°C)		∅ mm	cm/kg	Protected & compatible power generator (+/-15%)		
										IA (60%)	X% (I2 max)					
		<b>MIG CARPRO 230 V</b>	230V 1~	16	15 + 160	6	option			90	140A@15%	0,6+1	0,6/0,8	0,8	47x77x79 / 46	5.2 kVA
		<b>GOLD MULTI AUTO</b>	110V 1~ 230V 1~	32 16	20 + 150 20 + 200	-				100 130	150 A @22% 200 A @22%	0,6+1	0,8/1,0	0,8	41x73x77 / 37	7.5 kW





MIG CARPRO

# MIG/MAG INVERTER SYNERGIC

Lastest generation colour screen 3.5"

**NEW**

16 languages

- French
- English
- German
- Italian
- Spanish
- Portuguese
- Czech
- Polish
- Dutch
- Swedish
- Russian
- Chinese
- Japanese
- Vietnamese
- Finnish
- Turkish

EASY



EXPERT

Pre-gas / Creep speed / Hotstart / Crater filler / Burnback / Post-gas

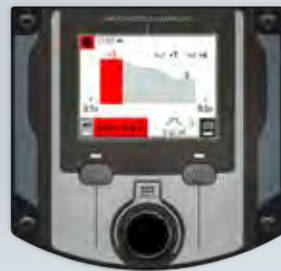

**EASY TO SETUP**



**MODES**

- MANUEL
- SYNERGIC EASY / EXPERT
- 2T
- 4T
- SPOT
- DELAI

**FONCTIONS**

- TRACEABILITY
- PORTABILITY
- +500 JOBS can be saved

**SYNERGIES**

- STEEL
- AlSi
- AlMg
- Cu Si 3 / CuAl 8
- CrNi

**UPDATES**



USB key 16 Gb 062344

MIG CARPRO E1

10 → 200 A 230V 1~ PFC

with accessories :

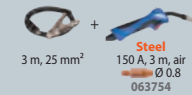

076877

MIG CARPRO E2

10 → 200 A 230V 1~ PFC

with accessories :

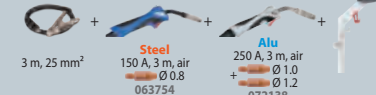

076884

MIG CARPRO E3

10 → 200 A 230V 1~ PFC

with accessories :

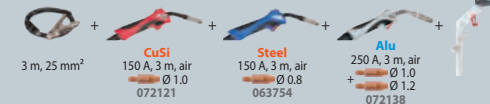

076891

**NEW**



10 m³ (50L)

1 x

6 m

MIG CARPRO E1 200 A • × 1

	MIG CARPRO E1	MIG CARPRO E2	MIG CARPRO E3
1	Ø 200 / 300	Ø 200	Ø 200
2	-	Ø 200 / 300	Ø 200
3	-	-	Ø 200

PFC POWER FACTOR CORRECTION

195 V ← 265 V

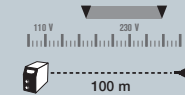

2 x 4 m³ (20L)

2 x

6 m

MIG CARPRO E2 200 A • × 2

2 x 4 m³ (20L)

3 x

6 m

MIG CARPRO E3 200 A • × 3

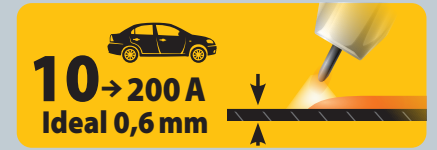

MADE IN FRANCE	CE NORM. 60974/1	50/60 Hz	A	6 m	min → max	Ø mm		Electronic Control	EN60974-1 (40°C)		Original equipment Equipement d'origine Originalausstattung Equipamiento de fabrica	cm	kg	Protected & compatible power generator (+/-15%)
						200	300		IA (60%)	X% (I2 max)				
▪	MIG CARPRO E1	230V 1 ~	16	6 m	10 → 200	▪	▪		145	20	Acier Type B 0.6/0.8	74 x 49 x 78	43	9KVA
▪	MIG CARPRO E2	230V 1 ~	16	6 m	10 → 200	▪	▪		145	20	Acier Type B 0.6/0.8 Alu Type B 0.8/1	87.5 x 63 x 90	49	9KVA
▪	MIG CARPRO E3	230V 1 ~	16	6 m	10 → 200	▪	▪		145	20	Acier Type B 0.6/0.8 Acier Type B 0.8/1 Alu Type B 0.8/1	87.5 x 63 x 90	51	9KVA





CARPULSE

# MIG/MAG INVERTER DOUBLE PULSE

Latest generation colour screen 5" 800 x 480 (WVGA)

1 EASY

2 EXPERT Pre-gas / Hot Start / Upslope / Downslope / Crater filler / Post-gas

3 ADVANCED Arc length adjustments

## ACCESSIBILITY

3 interface levels

- EASY
- EXPERT
- ADVANCED

16 languages

- French
- English
- German
- Italian
- Spanish
- Portuguese
- Czech
- Polish
- Dutch
- Swedish
- Russian
- Chinese
- Japanese
- Vietnamese
- Finnish
- Turkish

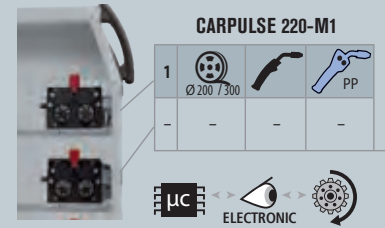

CARPULSE 220-M1

15 220 A 230V 1~ PFC

with accessories:

- 4 m, 35 mm<sup>2</sup> 043817
- 250 A, 3 m, air + 072138

066632

PFC POWER FACTOR CORRECTION

185 V ~ 265 V



BODYSHOP SPECIFIC COLD PULSE CuSi3 Ø 0.8/1



3 INTERFACE LEVELS

500+ JOBS can be saved



TRACEABILITY

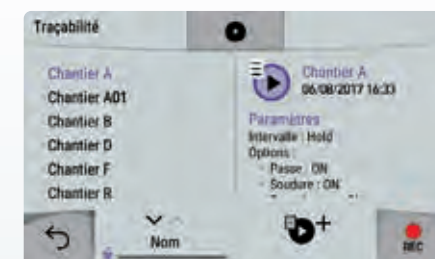

PORTABILITY



MODES

- DYNAMIC STANDARD
- PULSE
- PULSE IN PULSE
- MANUAL
- COLD PULSE

FULLY DIGITAL

4 MICROPROCESSORS

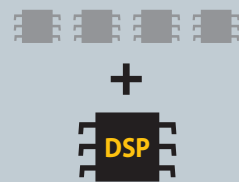

65+ SYNERGIES

Find all the synergies: Retrouvez toutes les synergies: Finde alle Synergien:



STEEL  
Cu Si 3 / Cu Al 8  
ALU

UPDATES

EASY USB UPDATE

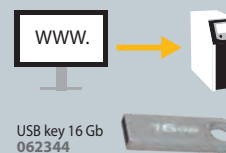

10 m<sup>2</sup> (50L) 1 x

**OPTIONS**

**PUSH PULL TORCH 24 V**

MB 25 4m 046283

Motor inside

**Torch gas flow-meter - Débitmètre de bout de torche**

053939

**NEW**

MB 15 / MB 25 (250 A) 077089

- x5 (M6-Ø 0.6)
- x5 (M6-Ø 0.8)
- x5 (M6-Ø 1.0)
- x5 (Alu-Ø 0.8)
- x5 (Alu-Ø 1.0)
- x5 (Alu-Ø 1.2)

220 A • x 1

MADE IN FRANCE CE NORM. EN60974-1	50 / 60 Hz	8 m	16	0.6+1.2	15+220	-	OPTION	200 300	Air	ELECTRONIC CONTROL	Original equipment d'origine / Equipement Originalausstattung / Equipamiento de fabrica		EN60974-1 (40°C)		Protected & compatible power generator (+/-15%)
											IA (60%)	X% (12 max)	cm / kg	10 kVA	
<b>CARPULSE 220-M1</b>	230 V · 1 ~	8 m	16	0.6+1.2	15+220	-	OPTION	■ ■	Air		ALU : Type B 1.0 / 1.2	150	220 A @ 20%	88x93x63 / 69	10 kVA

MIG/MAG • INVERTER

81

jms PRO





CARPULSE

# MIG/MAG INVERTER DOUBLE PULSE

BODYSHOP SPECIFIC  
**COLD PULSE**  
CuSi3 Ø 0.8/1



2 x 4 m<sup>3</sup> (20L)  
3 x

**PFC** POWER FACTOR CORRECTION  
185 V ← 265 V  
  
100 m

**CARPULSE 220-M3**

1			
2			-
3			-

**LIC ELECTRONIC**

**CARPULSE 220-M3**

**15 220 A** 230V 1~ **PFC**

with accessories:

4 m, 35 mm<sup>2</sup> 043817 + CuSi 150 A, 3 m, air Ø 1.0 072121 + Steel 150 A, 3 m, air Ø 0.8 063754 + Alu 250 A, 3 m, air Ø 1.0 Ø 1.2 072138

036819

**OPTIONS**

**PUSH PULL TORCH 24 V**

MB 25 4 m 046283 Motor inside

MB 15 / MB 25 (250 A) 077089 **NEW**

x5 (M6-Ø 0.6)  
x5 (M6-Ø 0.8)  
x5 (M6-Ø 1.0)

x5 (Alu - M6-Ø 1.0)  
x5 (Alu - M6-Ø 1.2)

Torch gas flow-meter - Débitmètre de bout de torche 053939

CARPULSE 320-T1				CARPULSE 320-T3				CARPULSE 320-T3 208-240V			
1				1				1			
2	-	-	-	2				2			-
3	-	-	-	3			-	3			-

**LIC ELECTRONIC**

**CARPULSE 320-T1**

**15 320 A** 400V 3~ **NEW**

with accessories:

4 m, 35 mm<sup>2</sup> 043817 + Alu 250 A, 3 m, air Ø 1.0 Ø 1.2 072138

072916



10 m<sup>3</sup> (50L)  
1 x

5 m

5 m

3 x

**CARPULSE 320-T3**

**15 320 A** 400V 3~

with accessories:

4 m, 35 mm<sup>2</sup> 043817 + Steel 250 A, 3 m, air Ø 1.0 072152 + Steel 250 A, 3 m, air Ø 0.8 072145 + Alu 250 A, 3 m, air Ø 1.0 Ø 1.2 072138

071209

**CARPULSE 320-T3 208-240V**

**15 320 A** 208>240V 3~ **PFC**

with accessories:

4 m, 35 mm<sup>2</sup> 043817 + Steel 250 A, 3 m, air Ø 1.0 072152 + Steel 250 A, 3 m, air Ø 0.8 072145 + Alu 250 A, 3 m, air Ø 1.0 Ø 1.2 072138

067233

**OPTIONS**

for CARPULSE 320-T3 (400 V) only

**SPOOLGUN TORCH**

**Ideal Alu**

Ø 0,8

4 m 041486 Ø 100

Motor inside

**220 A** • x 3

**320 A** • x 1

**320 A** • x 3

	MADE IN FRANCE	EN60974-1	50 / 60 Hz	A	Ø mm	min → max	A	SPOOLGUN	PUSH/PULL	200	Cooling system	Equipement d'origine Original equipment Originalausstattung Equipamiento de fabrica		EN60974-1 (40°C)	cm / kg	Protected & compatible power generator (+/-15%)	
												IA (60%)	X% (I2 max)				
											Air		ACIER : Type B 0.8 / 1.0 mm ALU : Type B 1.0 / 1.2	150	220 A @ 20%	88x93x63 / 69	10 kVA

	MADE IN FRANCE	EN60974-1	50 / 60 Hz	A	Ø mm	min → max	A	SPOOLGUN	PUSH/PULL	200 300	Cooling system	Original equipment Equipement d'origine Originalausstattung Equipamiento de fabrica		EN60974-1 (40°C)	cm / kg	Protected & compatible power generator (+/-15%)	
												IA (60%)	X% (I2 max)				
											Air		ALU : Type B 1.0 / 1.2	260	320 A @ 35%	90x92,5x63 / 82.5	16 kVA
											Air		ACIER : Type C 0.8 / 1.0 mm ALU : Type C 1.0 / 1.2	260	320 A @ 35%	75x40x94 / 82.5	16 kVA
											Air		ACIER : Type C 0.8 / 1.0 mm ALU : Type C 1.0 / 1.2	260	320 A @ 35%	75x40x94 / 82.5	16 kVA



**MANUAL TORCHES** - Torches manuelles - Brenner - Antorcha - Lastoort - Tocha

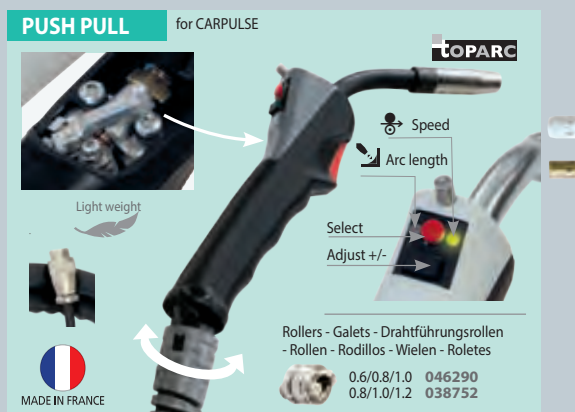
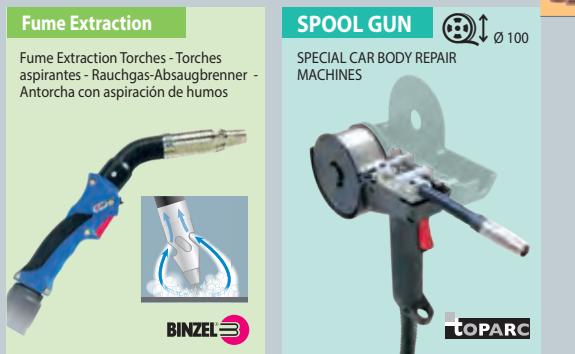

**Boxes - Coffrets - Verschleißteilebox - Cajas - Kistjes - Estojos**

MB 15 (150A)	MB 15 / MB 25	MB 25 (250A)	MB 36 (350A)
041226	077089	041233	041417
x3	x5 (M6-Ø0.6) x5 (M6-Ø0.8) x5 (M6-Ø1.0)	x5	x2
x5	x5 (M6-Ø0.8) x5 (M6-Ø1.0) x5 (Alu-M6-Ø1.0)	x3	x3
x5 (M6-Ø0.6) x5 (M6-Ø0.8) x5 (Alu-M6-Ø0.8)	x5 (M6-Ø0.8) x5 (M6-Ø1.0) x5 (Alu-M6-Ø1.0)	x5 (M6-Ø0.8) x5 (M6-Ø1.0) x5 (Alu-M6-Ø1.0)	x5 (M8-Ø1.0) x5 (M8-Ø1.2) x5 (Alu-M8-Ø1.0) x5 (Alu-M8-Ø1.2)
x3	x3	x2	x2

Guide gaine téflon pour dévidoir 079601 **NEW**

**Torch liners - Gainses - Mantel - Funda - Drahtseelen - Folha**

ACIER - STEEL - STAHL - ACERO - STAAL - AÇO	TEFLON	CARBON
Ø0.6/0.8	3m 041578 4m 044050 4m 041837 3m 041585 4m 040467 3m 041608 4m 041844 5m 062276	Ø0.6x0.8 4m 039834 5m 062306 Ø1.0x1.2 4m 039827 5m 062313 Ø1.2x1.6 4m 039810
Ø1.0	3m 041847 4m 041844 5m 062276	Ø0.6x0.8 4m 039834 5m 062306 Ø1.0x1.2 4m 039827 5m 062313 Ø1.2x1.6 4m 039810
Ø1.2	3m 041847 4m 041844 5m 062276	Ø0.6x0.8 4m 039834 5m 062306 Ø1.0x1.2 4m 039827 5m 062313 Ø1.2x1.6 4m 039810
Ø1.4	3m 041847 4m 041844 5m 062276	Ø0.6x0.8 4m 039834 5m 062306 Ø1.0x1.2 4m 039827 5m 062313 Ø1.2x1.6 4m 039810
Ø1.6	3m 041847 4m 041844 5m 062276	Ø0.6x0.8 4m 039834 5m 062306 Ø1.0x1.2 4m 039827 5m 062313 Ø1.2x1.6 4m 039810
Ø2.4	3m 041847 4m 041844 5m 062276	Ø0.6x0.8 4m 039834 5m 062306 Ø1.0x1.2 4m 039827 5m 062313 Ø1.2x1.6 4m 039810
<b>PUSH PULL TORCH</b>		
Ø1.0/1.2	8m 038172	

**CONSUMABLES - Consommables**

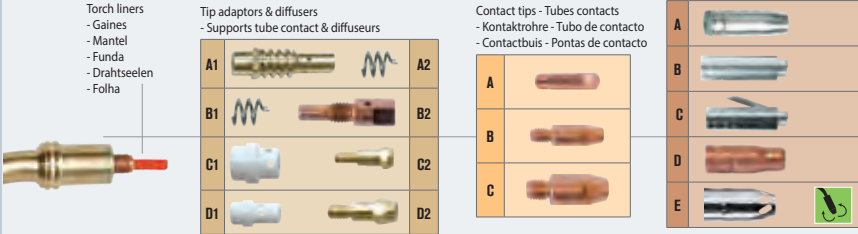

**Complete Torches - Torches complètes - Brenner - Antorcha - Lastoort - Tocha**

	Acier / Inox - Steel/Stainless steel - Stahl/Edelstahl						ALU - Aluminium - Aluminio					PUSH PULL		SPOOL GUN
	AIR			LIQUID			AIR			LIQUID		AIR	AIR	
	150A	150A	250A	250A	350A	300A	150A	250A	250A	350A	300A	150A	250A	150A
X% 40°C, ArCo	150A 60%	150A 60%	150A 60%	200A 60%	290A 60%	270A 100%	150A 60%	230A 60%	200A 60%	290A 60%	270A 100%	220A 20%	150A 60%	
	M6 Ø0.8	A1+A2 Ø1.0	B1+B2 Ø0.8	B1+B2 Ø1.0	D1+D2 Ø1.2	C1+C2 Ø1.2	A1+A2 Ø0.8	B1+B2 Ø1.2	B1+B2 Ø1.0	D1+D2 Ø1.2	C1+C2 Ø1.2	B1+B2 Ø1.2	M6 Ø0.8	A1+A2 Ø0.8
	3m	3m	3m	3m	4m	3m	3m	3m	3m	3m	3m	4m	4m	4m
	063754	072121	072145	072152	063792	040694	063761	072138	063785	063808	040748	046283	041486	
	3m			4m	3m	4m	3m			3m	3m	4m		
	041424			063778	040687	043275	041462			040724	CARBON 040731	043282		
	3m			3m	4m					4m	4m			
	043268			040700	040946					040939	CARBON 040953			
	3m			4m	4m									
	043251			040922	040557									
				3m										
				040540										

**Tip adaptors & diffusers - Supports tube contact & diffuseurs**

	Acier / Inox - Steel/Stainless steel - Stahl/Edelstahl						ALU - Aluminium - Aluminio					PUSH PULL		SPOOL GUN
	AIR			LIQUID			AIR			LIQUID		AIR	AIR	
	150A	150A	250A	250A	350A	300A	150A	250A	250A	350A	300A	150A	250A	150A
	A1 (x5)	A1 (x5)	B1 (x5)	B1 (x5)	D1 (x3)	C1 (x3)	A1 (x5)	B1 (x5)	B1 (x5)	D1 (x3)	C1 (x3)	A1 (x5)	B1 (x5)	A1 (x5)
	042902	042902	042995	042995	043008	043589	042902	042995	042995	043008	043589	042902	042995	042902
	A2 (x10)	A2 (x10)	B2 (x5)	B2 (x5)	D2 (x5)	C2 (x5)	A2 (x10)	B2 (x5)	B2 (x5)	D2 (x5)	C2 (x5)	A2 (x10)	B2 (x5)	A2 (x10)
	042988	042988	042919	042919	042926	043541	042988	042919	042919	042926	043541	042988	042919	042988

**Contact tips - Tubes contacts - Kontaktrohre - Tubo de contacto - Contactbuis - Pontas de contacto**

	150A	150A	250A	250A	350A	300A	150A	250A	250A	350A	300A	150A	250A	150A
Ø0.6	A (x10)	A (x10)	A (x10)	A (x10)	—	A (x10)	—	—	—	—	—	—	—	—
	041905	041905	041905	041905	—	041905	—	—	—	—	—	—	—	—
Ø0.8	A (x10)	A (x10)	B (x10)	B (x10)	C (x10)	B (x10)	B (x10)	A (x10)	B (x10)	—	B (x10)	B (x10)	B (x10)	B (x10)
	041912	041912	041950	041950	041790	041950	041059	041059	041059	—	041059	041059	041059	041059
Ø1.0	A (x10)	A (x10)	B (x10)	B (x10)	C (x10)	B (x10)	B (x10)	B (x10)	B (x10)	C (x10)	B (x10)	B (x10)	B (x10)	B (x10)
	041929	041929	041967	041967	0419803	041967	041066	041066	041066	0419766	041066	041066	041066	041066
Ø1.2	A (x10)	A (x10)	B (x10)	B (x10)	C (x10)	B (x10)	B (x10)	B (x10)	B (x10)	C (x10)	B (x10)	B (x10)	B (x10)	B (x10)
	040144	040144	041974	041974	0419810	041974	041073	041073	041073	0419773	041073	041073	041073	041073
Ø1.4	—	—	—	—	C (x10)	—	—	—	—	—	—	—	—	—
	—	—	—	—	419827	—	—	—	—	—	—	—	—	—
Ø1.6	—	—	—	—	C (x10)	—	—	—	—	—	—	—	—	—
	—	—	—	—	419834	—	—	—	—	—	—	—	—	—
Ø2.4	—	—	—	—	C (x10)	—	—	—	—	—	—	—	—	—
	—	—	—	—	040533	—	—	—	—	—	—	—	—	—

**Gas nozzles - Buses - Düsen - Tubo - Nippel - Bicos**

	150A	150A	250A	250A	350A	300A	150A	250A	250A	350A	300A	150A	250A	150A
	Ø12	Ø12	Ø15	Ø15	Ø16	Ø17	—	—	—	—	—	—	—	—
	A (x3)	A (x3)	A (x3)	A (x3)	A (x3)	A (x3)	—	—	—	—	—	—	—	—
	041875	041875	041882	041882	041783	043534	041875	041882	041882	041783	043534	041875	041882	041875
Conical nozzle	E (x1)	E (x1)	E (x1)	E (x1)	E (x1)	—	—	—	—	—	—	—	—	—
	043084	043084	040571	040571	040588	—	—	—	—	—	—	—	—	—
Spot welding	B (x1)	B (x1)	—	—	—	—	—	—	—	—	—	—	—	—
	041851	041851	—	—	—	—	—	—	—	—	—	—	—	—
Nail welding	C (x1)	C (x1)	—	—	—	—	—	—	—	—	—	—	—	—
	041523	041523	—	—	—	—	—	—	—	—	—	—	—	—
Special No Gas	D (x1)	D (x1)	—	—	—	—	—	—	—	—	—	—	—	—
	041868	041868	—	—	—	—	—	—	—	—	—	—	—	—

**WELDING WIRE REELS - Bobines de fil - Drahtrollen - Rollos de hilo - Draadbobijn - Bobines de filo**

for	kg	Ø	EXCELLIUM					NORMES - Norms - Normen - Norma			
			Ø0.8mm	Ø1.0mm	Ø1.2mm	AWS	EN	DIN			
Acier - Steel - Stahl - Acero - Staal - Aço (SG2)	0.9	100 mm	—	086593	086609	—	—	—	5.18 : ER 70S-6	ISO 14341-A : G46 4M G3511	8559 : SG2
	5	200 mm	—	086111	086128	—	—	—	5.18 : ER 70S-3	ISO 14341-A : G42 2M 2511	8559 : SG1
	15	300 mm	—	086166	086227	—	—	—	5.28 : ER 90S-B3	ISO 2195L-A : Cr CrMo251	—
	18	—	300 mm	—	086272	—	—	—	5.28 : ER 120 S-G	ISO 16834 : Mn4Ni2, 5CrMo	—
	5	200 mm	—	086418	086401	—	—	—	ASME SFA-5.28 : ER 120 S-G	ISO 12534 : Mn4Ni2, 5CrMo	—
	15	300 mm	—	—	086258	—	—	—	—	—	—
	5	200 mm	—	—	077157	—	—	—	—	—	—
	5	200 mm	—	—	086203	—	—	—	—	—	—
	0.9	100 mm	—	—	086104	—	—	—	—	—	—
	4.5	200 mm	—	—	086265	086623	086630	—	—	—	—
Acier - Steel - Stahl - Acero - Staal - Aço (CrMo251)	15	300 mm	—	—	086388	086395	—	—	—	—	—
	16	—	300 mm	—	—	—	—	—	—	—	—
	5	200 mm	—	086760	086777	—	—	—	—	—	—
	1	100 mm	—	—	086692	—	—	—	—	—	—
	2 kg	200 mm	—	—	077393	—	—	—	—	—	—
	5 kg	200 mm	—	—	086647	—	086654	086210	—	—	—
	2 kg	200 mm	—	—	077409	—	—	—	—	—	—
	5 kg	200 mm	—	—	086661	—	086197	—	—	—	—
	15	300 mm	—	—	—	—	086180	—	—	—	—
	1	100 mm	—	—	086616	—	—	—	—	—	—
CusI3 HLE - UHTS (Boron Steel)	5	200 mm	—	—	086579	—	086340	—	—	—	—
	15	300 mm	—	—	—	—	086357	—	—	—	—
	5	200 mm	—	—	086326	—	086364	—	—	—	—
	15	300 mm	—	—	—	—	086371	—	—	—	—
	2	200 mm	—	—	—	—	—	—	—	—	—
	7	300 mm	—	—	—	—	—	—	—	—	—
	0.5	100 mm	—	—	086548	—	—	—	—	—	—
	2	200 mm	—	—	086555	—	086562	—	—	—	—
	7	300 mm	—	—</							



# WELDING HELMETS TECHNOLOGIES

	Intensity (A)														
	1.5	70	100	125	150	175	200	225	250	300	350	400	450	500	600
MAG	8	9	10				11			12				13	
MIG			9	10			11			12		13	14		
MIG light alloys				10	11		12			13		13			
PLASMA			9	10	11		13								

**Initial shade - Teinte initiale**

Classic

ULTRA CLEAR

**Spectrum view - Spectre de couleur**

Classic

TRUECOLOR

**Sensitivity sensors - Capteurs sensibles**

Classic

Sensors x2

HIGH SENSIBILITY

Sensors x4

**Classification - X=/X=/X=/X=**

1/1/1/1 = PERFECT QUALITY

(1) Optical quality (distortion). (2) Light diffusion (contrast). (3) Variation of light transmission (homogeneities of the dark shade). (4) Angular light (diagonal light ray filter).

(1) Qualité optique (distorsion). (2) Diffusion de la lumière (contraste). (3) Variation de la transmission lumineuse (homogénéités de la teinte foncée). (4) Lumière angulaire (filtre de rayons lumineux diagonaux).

(1) / (2) / (3) / (4)

**Headgear - Serre-tête**

Simple

Multi

MULTI PRO

MULTI PREMIUM  
Comfortable back

EN 175 - EN 379

## WELDING HELMETS 9-13

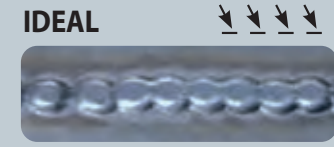

◀ 100 x 60 mm | □→■ 0.08 ms  
GRIND + (10 01) x4 TRUECOLOR

EN 175 - EN 379

## WELDING HELMETS 5-9/9-13



◀ 100 x 49 mm | □→■ 0.1 ms  
GRIND TRUECOLOR

◀ 100 x 67 mm | □→■ 0.1 ms GRIND + (10 01) x4 TRUECOLOR



OPTIONS

Carry bag for helmet welding - Sac pour masque de soudage  
043299

Antiperspirant headband - Bandeau anti-transpiration  
043466 for Simple, Multi, Multi Premium  
062627 for Multi Pro  
070844 for Gysmatic 9/13 Air, Gysmatic 5/13 Air XXL

Magnifying glass - Loupe for Zeus, Ergotech & Alien True Color  
x1 zoom x2 042780  
zoom x3 064140

LENSES - Verres - Schutzgläser	Dimensions	Code	Model	Shade	TRUECOLOR	HF	DELAY	Sensitivity	Optics	Weight	MASK BRAND			
226 x 106 (x5)	103.6 x 54 (x5)	045781 040809	LCD FIREMAN 9-13 TRUECOLOR	3/5-9/9-13	■	—	0.10 ms	0.15 > 0.8 s	1/1/1/2	2	100x49 mm	Multi	490 g	Gys
114x133 (x10)	G: 106 x 66 (x10)	043893 043886	LCD GYSMATIC 9/13 G TRUECOLOR	4-9>13	■	✓	0.08 ms	0.10 > 0.90 s	1/1/1/2	4 HIGH SENSIBILITY	XL: 100x60 mm	Simple	580 g	Gys
114 x 133 (x10)	103.7 x 69.5 (x5)	043893 043695	ZEUS	4-5>9/9>13	■	—	0.10 ms	0.15 > 0.8 s	1/1/1/2	4	XL: 100x67 mm	Multi	520 g	Gys



WELDING HELMETS  
5-9/9-13

ERGOTECH +

- ◀ 100 x 67 mm
- GRIND
- ULTRA CLEAR 3
- CLASS 1/1/1/1
- TRUECOLOR
- Multi Premium



ERGOTECH + 5-9/9-13  
SILVER  
068650



ERGOTECH + 5-9/9-13  
BLACK  
068667

ALIEN +



ALIEN XXL +  
TRUECOLOR  
068698

- ◀ 100 x 90 mm
- GRIND
- ULTRA CLEAR 3
- CLASS 1/1/1/1
- TRUECOLOR
- Multi Premium



GYSMATIC XL  
TRUECOLOR  
037908

- ◀ 100 x 60 mm
- GRIND
- CLASS 1/1/1/1
- TRUECOLOR



ERGOTECH + 5-9/9-13  
DREAM  
068674



Multi Pro



GYSMATIC XXL  
TRUECOLOR  
037236

- ◀ 100 x 83 mm
- GRIND
- CLASS 1/1/1/1
- DIGITAL
- TRUECOLOR
- MEMORY & REGULATIONS ELECTRONIC

PANORAMIC

APOLLO +



APOLLO + 5-9/9-13 G  
TRUECOLOR  
068681

- ◀ 100 x 67 mm
- GRIND
- ULTRA CLEAR 3
- CLASS 1/1/1/1
- TRUECOLOR
- PANORAMIC



PANORAMIC 3XL  
TRUECOLOR  
037281

- ◀ 114 x 85 mm
- GRIND
- ULTRA CLEAR 3
- CLASS 1/1/1/1
- TRUECOLOR
- PANORAMIC

OPTIONS



Carry bag for helmet welding  
Sac pour masque de soudage  
043299



066656

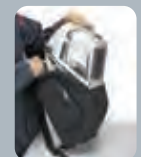

Antiperspirant-headband  
- Bandeau anti-transpiration

043466 for Multifit+, Ergofit + Multi, Simple

062627 for Confort Pro

070844 for Gysmatic 9/13 Air, Gysmatic 5/13 Air XXL



Magnifying glass - Loupe for Zeus, Ergotech & Alien True Color x1 zoom x2 042780 x3 zoom x3 064140

LENSES - Verres - Schutzgläser

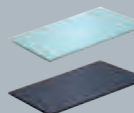

Model	Dimensions	GRIND	ULTRA CLEAR	CLASS	TRUECOLOR	Multi Premium	Weight	Brand
ERGOTECH +	114 x 133 (x10) 043893 / 103.7 x 69.5 (x5) 043695	3-5>9/9>13	0.10 ms	1/1/1/1	4 HIGH SENSITIVITY	XL: 100x67 mm	580 g	Gys
ALIEN XXL + TRUECOLOR	114 x 133 (x10) 043893 / 104 x 96 (x5) 043596	3-5>9/9>13	0.10 ms	1/1/1/1	4 HIGH SENSITIVITY	XXL: 100x90 mm	560 g	Gys
GYSMATIC XL TRUECOLOR	110 x 90 (x5) 040816 / 106 x 66 (x10) 043886	4-5>9/9>13	0.08 ms	1/1/1/1	4 HIGH SENSITIVITY	XL: 100x60 mm	540 g	Gys
GYSMATIC XXL TRUECOLOR	114 x 133 (x10) 043893 / 106 x 89.5 (x10) 046825	4-5>9/9>13	0.10 ms	1/1/1/1	4 HIGH SENSITIVITY	XXL: 100x83 mm	680 g	Gys
APOLLO + 5-9/9-13 G	114 x 133 (x10) 043893 / 103.7 x 69.5 (x5) 043695	3-5>9/9>13 + 2x: 5	0.10 ms	1/1/1/1	4 HIGH SENSITIVITY	XL: 100x67 + 2x103.7x69.5 mm	580 g	Gys
PANORAMIC 3XL TRUECOLOR	390 x 150 (x3) 037311 / special kit (x1) 037304	3-4>8/8>12 + 2x: 3>10	0.15 ms	1/1/1/1	4 HIGH SENSITIVITY	114x85 + 2x(68x80) mm	610 g	Gys



WELDING HELMETS  
VENTILATED

IDEAL



**GYSMATIC XXL & GYSMATIC 5/13 AIR XXL**

**DIGITAL MEMORY & REGULATIONS ELECTRONIC**

memory saving x3



**LCD GYSMATIC 9/13 G AIR TRUECOLOR**  
065727  
069602

100 x 60 mm

0.08 ms



included with LCD GYSMATIC 9/13 G TRUECOLOR



**GYSMATIC 5/13 AIR XXL TRUECOLOR**  
047846  
028852

100 x 83 mm

0.1 ms

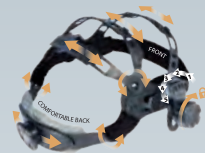

Multi Pro

**Filtration class EN 12941: TH2 P R SL**  
Air 165 / 200  
220 L/min  
Battery included

**OPTION Filter TH3**  
065734



Battery charger  
037472  
028869



Battery included  
037465



038424 x1



038417 x5

LENSES - Verres - Schutzgläser

Model	Dimensions	Weight	Response Time	Delay	Sensitivity	Viewing Area	Optics	Mask Brand
LCD GYSMATIC 9/13 G TRUECOLOR	114 x 133 (x10)	580 g	0.08 ms	0.10 > 0.90 s	4 HIGH SENSITIVITY	XL: 100x60 mm	Simple	Gys
GYSMATIC 5/13 AIR XXL TRUECOLOR	114 x 133 (x10)	680 g	0.10 ms	0.1 > 0.9 s	4 HIGH SENSITIVITY	XXL: 100x83 mm	Multi Pro	Gys

FUME EXTRACTION SYSTEMS - Aspirateurs de fumée - Rauchgasabsauggerät

UNI 2.0 RE

- 400V 3 ~
  - 50 Hz
  - 1100 W
  - 1500 m<sup>3</sup>/h max
  - arm 3 m
  - no plug
  - 100 kg
  - extraction 0.5 m/s
- 061545



**Included**  
Pré filtre, treillis Aluminium  
Class of filtration G3 EN 779  
+ Filtre - Coal Filter EPA E12  
EN 779, Filtration >99.5 %  
046467

**Options**  
Filtre à charbon actif -  
Coal filter  
UNI 2.0 RE  
064522

EVO 2.1 RE

- 230V 1 ~
- 50 Hz
- 1100 W
- 1200 m<sup>3</sup>/h max
- occasional
- arm 3 m
- included
- 85 kg

061552

Patented - Breveté



**Included**  
Pré filtre, treillis Aluminium  
Class of filtration F15 G2 EN 779  
+ Filtre - Coal Filter HEPA H13  
EN 779, Filtration >99.95%  
046498

FUME EXTRACTION TORCHES - Torches aspirantes - Rauchgas-Absaugbrenner - Antorcha con aspiración de humos



	Steel/Stainless steel - Acier/Inox - Stahl/Edelstahl			
	AIR 150 A	250 A	350 A	LIQUID 500 A
original equipment	M6	M6	M8	M8
Ø	Ø 0.8	Ø 1.0	Ø 1.2	Ø 1.2
X % 40°C - ArCo <sub>2</sub>	150A - 60%	200A - 60%	290A - 60%	380A - 100%
GRIP	GRIP	GRIP	GRIP	GRIP
L	3 m	3 m	4 m	4 m
Ref.	043251	040540	040557	040564



For fume Extraction Torches - Pour torches aspirantes

BINZEL  
073715



- 230V / 1 ~, 1100 W
- 230 m<sup>3</sup>/h max
- 190 mbar max
- 25 kg, 590 x 425 x 825 mm
- 76 db
- Filter auto cleaning system - Système de nettoyage automatique du filtre - Automatische Filterabreinigung

Filtre Classe M, EN 60335-2-69

included: 5 m, Ø50

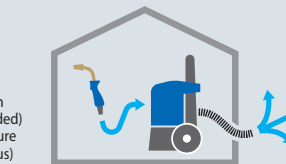

• External evacuation Ø50 (hose not included)  
- Evacuation extérieure Ø50 (tuyau non inclus)





# INDUCTION HEATING

1 200 · 22 000 W

POWERDUCTION 94

ACCESSORIES & CONSUMABLES 100





# INDUCTION HEATING

CAR BODY

### INCLUDED POWERDUCTION

- Plastic wedges 051294
- Burn off Inductor 053373
- Body Inductor 053359
- Bolt Inductor 053366
- Remote control 055490

### OPTIONS

- Universal 800 051331
- Cable support 052284
- Dent pulling Inductor 054776
- Spiral inductor 054783

### PFC POWER FACTOR CORRECTION

185 V ← 265 V

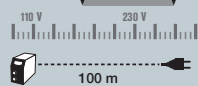

055490

### POWERDUCTION AUTO

2400 W 230 V • 1~

PFC AIR 053946

### CONSUMABLES

- for Protection (x5) + Stick - Colle 053854
- for Protection (x1) + Stick - Colle 059108
- for Protection (x10) + Stick - Colle 053847



- included For use < 3600W
- included C20/B1 056862



3 m

### COMBIDUCTION AUTO 50LG

5200 W 230 V • 1~

PFC LIQUID 072022



### INCLUDED COMBIDUCTION

- Glass Décapage Entfernen 053373
- Decal Décollage Entkleben 053359

### OPTIONS

- Spiral inductor - Inducteur spirale - Spiralinduktor 054783
  - Ø 18 mm 054806
  - Ø 24 mm 054790
  - Ø 30 mm 055469
  - 800 mm 054813
  - 800 mm 054868
- 1.2 kW 2.5 m
- PDR : Paintless Dent Repair - Débosselage sans peinture - Lackschadenfreies Ausbeulen 054776
- Licensed by BETAG innovation
- 3 m

- Freezer spray - Spray refroidisseur -50 °C 400 ml (x 12) 048898
- Adhesive for logo (x10) 051492

EN-60335/1	MADE IN FRANCE	A	W	kHz	PFC	Tech.	Freq.	Liquid Cooling	Cable L (m)		Heating			cm	kg	Protected & compatible power generator (+/-15%)
									Inductor	Inductor	Heating	Heating	Heating			
POWERDUCTION AUTO	230 V, 1~ , 50/60 Hz	16 mini	2400	35+100	■				2	2.5	M10 → 1 s	2 mm → 5 s	Ø8 → 10 s	36 x 27 x 22	7.5	3 kW
COMBIDUCTION AUTO 50LG	230 V, 1~ , 50/60 Hz	25 mini	5200	20+80	■	■ 71			8	3	M14 → 1 s	2 mm → 3 s 4 mm → 5 s	Ø10 → 10 s	59 x 88 x 59	72	6 kW





# INDUCTION HEATING

# 1.2 → 5.2 kW



### INCLUDED

Coil - Spirale - Spiralförmiger draht

- Ø 18 mm 054806
- Ø 24 mm 054790
- Ø 30 mm 055469

Flexible wrappable wire - Fil tressé enroulable - Flexibel geflochtener draht

- 800 mm 054813
- Straight rigid wire - Fil droit rigide - Steif gerade draht
- 800 mm 054868

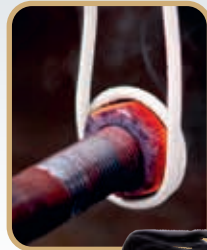

1 m

POWERDUCTION 10R

1 200 W

230 V • 1 ~

AIR

063389

### PFC POWER FACTOR CORRECTION

185 V ← 265 V

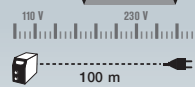

2 m

POWERDUCTION 37LG

3 700 W

230 V • 1 ~

\* LIQUID

058958



3 m

3 m

POWERDUCTION 39LG

3 700 W

230 V • 1 ~

PFC \* LIQUID

058965

POWERDUCTION 50LG

5 200 W

230 V • 1 ~

PFC \* LIQUID

058491

### OPTION 10R

Stripping - Décollage - Entkleben 066601



### OPTION 37LG

Cable support 052284

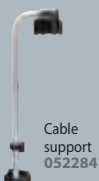

Trolley - Chariot UNIVERSAL 800 051331

### OPTION 50LG



Protection cover - Housses de protection - Schutzhaube 062733

MADE IN FRANCE	Cable L (m)	+AM+		Freq.	INTEGRATED TECHNOLOGY		* LIQUID COOLING	Cable L (m)			Heating		cm	kg	Protected & compatible power generator (+/-15%)
		A	W		kHz	P400		PFC	Inductor	Heating	Heating				
POWERDUCTION 10R	230V, 1~, 50/60 Hz	10 mini	1200	45+80	—	—	—	2	1	M10 → 1 s	2 mm → 5 s	Ø8 → 10 s	23 x 14 x 10	3	1.5 kW
POWERDUCTION 37LG	230V, 1~, 50/60 Hz	16 mini	3700	15+30	—	—	1.51	2	2	M10 → 1 s	2 mm → 5 s	Ø10 → 15 s	45 x 29 x 25	15	4 kW
POWERDUCTION 39LG	230V, 1~, 50/60 Hz	16 mini	3700	20+60	■	■	71	6	3	M12 → 1 s	2 mm → 5 s	Ø10 → 15 s	53 x 70 x 37	39.5	4 kW
POWERDUCTION 50LG	230V, 1~, 50/60 Hz	25 mini	5200	20+60	■	■	71	8	3	M14 → 1 s	2 mm → 3 s 4 mm → 5 s	Ø10 → 10 s	59 x 88 x 59	70	6 kW





# INDUCTION HEATING 11 → 22 kW



included adapter  
32L + L90  
064515 + 059788

4 m

included  
removable  
handle  
068599



included  
removable  
handle  
068599

included adapter  
32L + L90  
064515 + 059788

6 m



included adapter  
32L + L20/B4  
064515 + 067882

6 m  
or  
10 m

included  
removable  
handle  
068599

**POWERDUCTION 110LG**

**11 000 W** 400V • 3~

**LIQUID**

027909

**POWERDUCTION 110LG 208-240V**

**11 000 W** 208-240V • 3~

**LIQUID**

075436



**POWERDUCTION 160LG**

**16 000 W** 400V • 3~

**LIQUID**

058972

**POWERDUCTION 160LG 208-240 V**

**16 000 W** 208-240V • 3~

**LIQUID**

076501



**POWERDUCTION 220LG**

**22 000 W** 400V • 3~

**LIQUID**

066878

### OPTION

**Powerduction 160/220 LG over hanging arm-pulley**  
- Équilibreur Powerduction 160/220 LG

079441

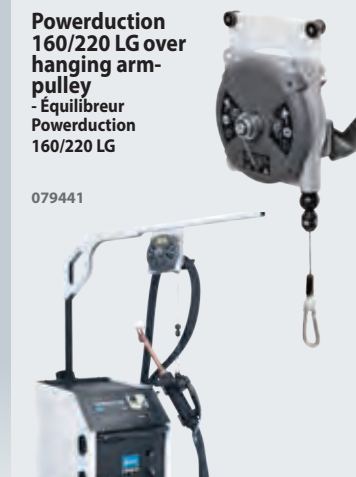

### t° POWER HEAT CONTROLLER

**t° CONTROL**  
80>350°C (210>660°F)



5,5m

**POWER HEAT CONTROLLER**  
061644

Included  
T° sensors  
thermocouple type K  
x2

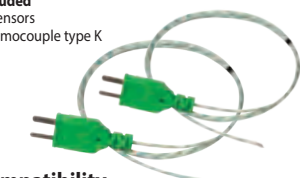

**Compatibility**  
POWERDUCTION 110LG  
POWERDUCTION 110LG 208-240V  
POWERDUCTION 160LG  
POWERDUCTION 160LG 208-240V  
POWERDUCTION 220LG

### OPTION



**Pyrometer IR**  
for inductor L90

1.1 m  
064119

### OPTIONS



Removable handle  
- Poignée de lance  
- Abnehmbarer Griff  
for POWERDUCTION  
220 - 160 - 110 LG  
068599



**Cooling liquid**  
Included with 160LG  
& 220 LG  
5L  
062511  
10L  
052246



Protection cover  
- Housse de protection  
- Schutzhaube  
for POWERDUCTION  
220 - 160 LG  
050853

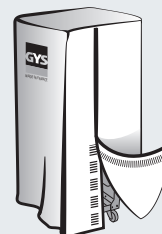

Protection cover  
- Housse de protection  
- Schutzhaube  
for POWERDUCTION  
110LG  
062733

MADE IN FRANCE	Cable L (m)	+AM+	Freq.	* Liquid Cooling	Cable L (m)		Heating		cm	kg	Protected & compatible power generator (+/-15%)		
					Inductor	Inductor	Heating	Heating					
<b>POWERDUCTION 110LG</b>	400V, 3~, 50/60 Hz	16 mini	11 000	20+60	71	5	4	M18 → 1 s	2 mm → 2 s 4 mm → 4 s	Ø10 → 7 s	59 x 88 x 59	80	15 kW
<b>POWERDUCTION 110LG 208-240V</b>	208-240V, 3~, 50/60 Hz	35 mini	11 000	20+60	71	5	4	M18 → 1 s	2 mm → 2 s 4 mm → 4 s	Ø10 → 7 s	59 x 88 x 59	86	15 kW
<b>POWERDUCTION 160LG</b>	400V, 3~, 50/60 Hz	32 mini	16 000	20+60	301	4	6	M20 → 1 s	2 mm → 2 s 4 mm → 4 s	Ø10 → 5 s	70 x 118 x 60	136	22 kW
<b>POWERDUCTION 160LG 208-240V</b>	208-240V, 3~, 50/60 Hz	45 mini	16 000	20+60	301	4	6	M20 → 1 s	2 mm → 2 s 4 mm → 4 s	Ø10 → 5 s	70 x 118 x 60	146	22 kW
<b>POWERDUCTION 220LG</b>	400V, 3~, 50/60 Hz	32 mini	22 000	20+60	301	4	6	M45 → 3 s	4 mm → 3 s 8 mm → 9 s	Ø10 → 4 s	70 x 118 x 60	141	22 kW









# PLASMA CUTTING







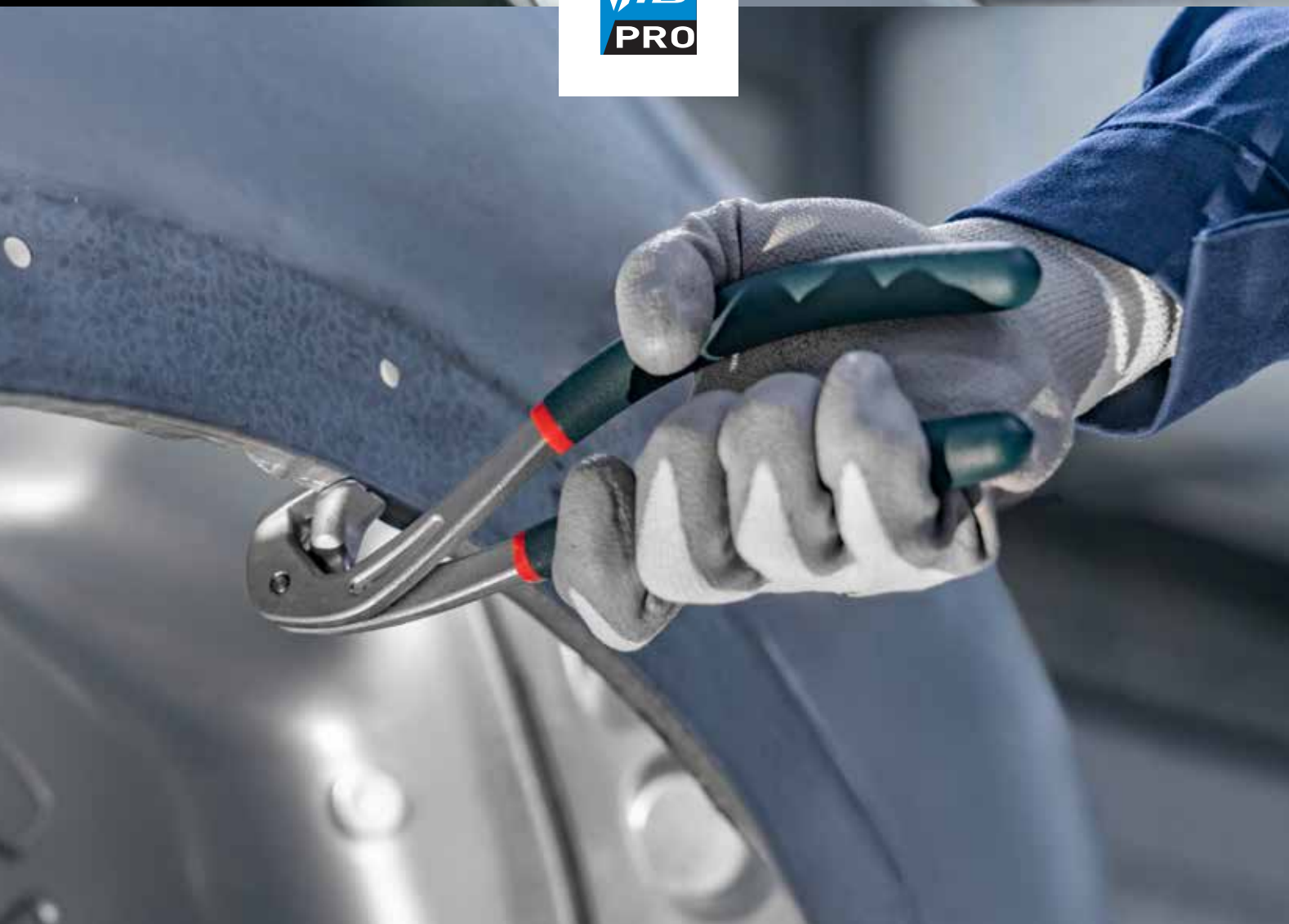

## + ACCESSORIES

WINDSCREEN REPAIR	108
BUMPER REPAIR	110
HAND TOOLS	112
PNEUMATIC TOOLS	114
SANDING & DUST EXTRACTION	116
WORKING LIGHTS	118
WORKING SUPPORTS	120
SAFETY PROTECTION	122



**PROFESSIONAL BOX SET FOR WINDSCREEN REMOVAL** - Coffret de découpe pare-brise  
- Frontscheiben-Trennsystem für Akkuschrauberbetrieb

MADE IN HIGH QUALITY GERMANY

057654

included  
Axe enrouleur  
068100

included  
65 m  
resistance 170 kg  
Ø 0.79 mm  
058125

optional  
65 m  
resistance 190 kg  
Ø 0.92 mm  
069275



**OSCILLATING PNEUMATIC SAW FOR WINDSCREEN REMOVAL** - Couteau pneumatique de découpe pare-brise  
- Druckluft-Trennmesser für Windschutzscheiben

057623



Included  
57 mm  
057845

90 mm  
057852

8 mm  
057876

35 mm  
057838

U  
36 mm  
057869

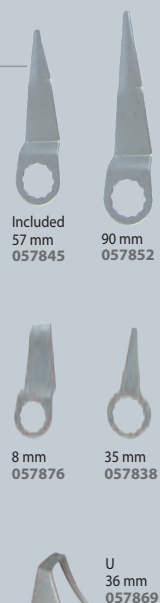

**REMOVAL TOOL FOR WINDSCREEN WIPER ARMS** - Extracteur d'essuie-glace - Wischerarm-Abzieher

UNIVERSEL  
057630



EXPERT

Accès difficile  
- Difficult access  
057647



**WINDSHIELD CUTTING KIT** - Système de découpe pare-brise à cliquet  
- Set zum Lösen von Windschutzscheiben

054738

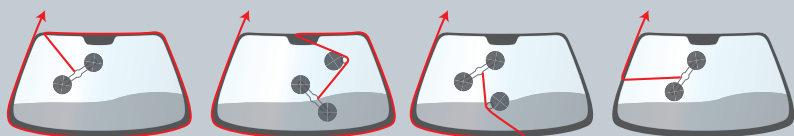

**DASHBOARD PROTECTOR** - Protections tableau de bord  
- Armaturenbrett Schutz

053120

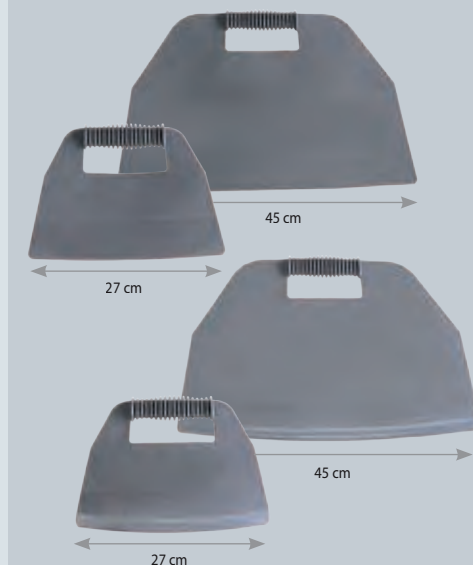

**WINDSHIELD CUTTING TOOL** - Outil découpe pare-brise  
- Windschutzscheiben Demontage-Set

051935

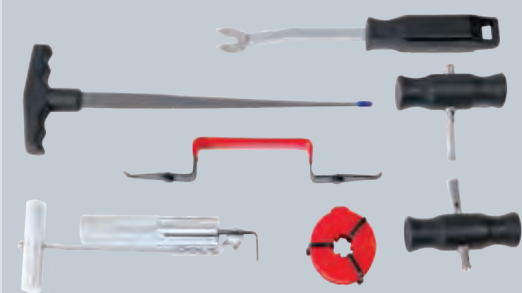

**WINDSCREEN JOINT-CUTTING KIT** - Kit découpe joint de pare-brise - Scheibentrenn-Werkzeug-Set

051898



Corde à piano torsadé (22 m)  
- Windscreen seal cutting wire  
(twisted)  
- Piano-Schneiddraht, gedreht,  
22 m Rolle  
051911

Corde à piano carré (50m)  
- Windscreen seal cutting wire  
(square)  
- Vierkant-Draht,  
50 m Rolle  
051881

**SUCTION LIFTING PADS** - Ventouses - Saugnapfwerkzeug für Spiegelgläser

056695



051966



x6  
057609

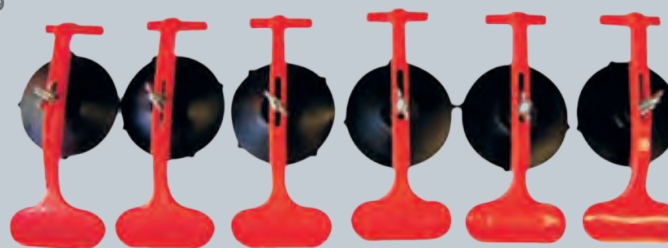

**COMPRESSED AIR POLISHER** - Renov'Polycarbonate - Druckluftpolierer

Complete pack

1 orbital sander  
+ 1 polisher  
- 1 ponceuse orbitale  
+ 1 lustreuse

052086



2 SPEED

+

+

+

+

+

+

052055

052062

052079

sander Ø75  
057494

polisher Ø75  
058224

Ø76

P 500 (x 10)  
P 800 (x 10)  
P 1500 (x 10)  
P 3000 (x 10)



P 500 x 50 052017  
P 800 x 50 052024  
P 1500 x 50 052031  
P 3000 x 50 052048





**HOT STAPLER FOR BUMPER REPAIR** - Agrafeuse pour réparation pare-chocs - Stoßstangen Reparatur Kit

052925



INCLUDED:  
x20 x20 x20 x20 x20

MADE IN TAIWAN

**PORTABLE**  
Battery operated - Sur batterie  
058118

included  
Li-ion battery 3.7V  
048669  
included adapters:  
EUR, UK, USA & AUS

Charger included  
048652

MADE IN TAIWAN



INCLUDED:  
Ø 0.6, x100 Ø 0.8, x100  
Ø 0.6, x100

Adjustable

**Staples - Agrafes**

Inside corner - Angle interne étroit Ø 0.7 mm	Crack alignment - Alignement de fissure Ø 0.7 mm	Large crack - Fissure importante Ø 0.7 mm	Internal angle - Angle interne Ø 0.7 mm	External angle - Angle externe Ø 0.7 mm
x 100 047990	x 100 047983	x 100 047976	x 100 047969	x 100 047952

052413  
= x 50 + x 50 + x 50 + x 50 + x 50

**PIERCING KIT FOR BUMPER SENSORS** - Coffret de perçage pare-chocs pour détecteurs - Lochwerkzeug für Stoßfänger



PRO+  
059139

Ø 17-18,18,2  
19-20-22,5-24  
26-26,7-32 mm



**FREEZER**

Freezer spray  
- Spray refroidisseur

-50 °C

400 ml

(x 12)  
048898



**TOOL FOR REMOVING BUMPER** - Outil de déclipsage pare-chocs

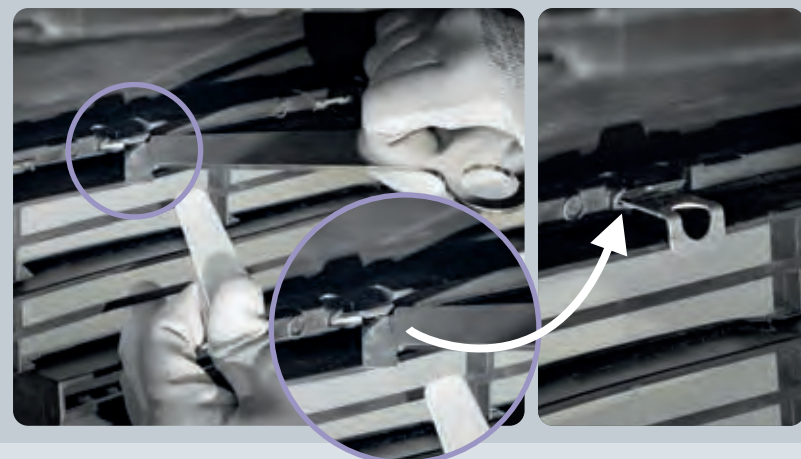

076518



NEW

x15  
076525

**PLASTIC WELDING STATION** - Station de soudage des plastiques - Kunststoff-Schweißset



320 W - 230 V, 1-50 Hz  
Temperature: 160 < 480°C  
▲ 3.4 kg  
Length of hose: 1 m  
Air flow: 24 l/min

Station seule  
- Station only  
064072



Ø 5 mm  
06669

Ø 8 mm  
066700

plastic rods - baguettes plastique 440 mm	PP / EPDM	▲ 4 mm	x 10	066304
		■ 6 mm	x 10	067622
		■ 8 mm	x 10	066298
ABS	▲ 4 mm	x 10	071322	
	■ 8 mm	x 10	071339	

Station	PP/EPDM 4mm (x10) 6mm (x10) 8mm (x10)	Pressure wheels	Mini milling machine	Scraper
064072	✓			
070974		✓		



**WELDING KIT FOR PLASTICS** - Kit de soudage des plastiques - Kunststoff-Schweißset



t°  
20 - 700°C

1 600 W - 230V - 50/60 Hz  
max. 230 l/min  
▲ 1.3 kg / ⌀ 100 x 300mm,  
poignée Ø 56mm.

057678

3m



20mm

x10  
052956

x1  
25 x 12.5 cm  
052949

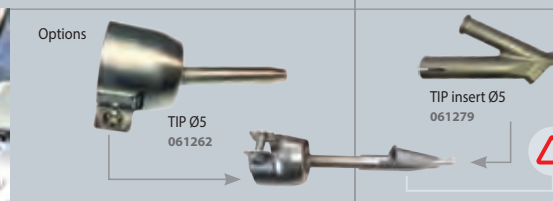



**HAND TOOLS - Ausbeulwerkzeug**

• **FULL PACK = 061637**

MADE IN GERMANY

50 mm

15

290 mm

275 mm

50 mm

390 mm

Ø 50 mm

053311

053298

061309

053335

053342

053328

053281

**MADE IN HIGH QUALITY GERMANY**

+ • **MEDIUM PACK 051133**

55

450 mm

051430

051416

051454

051447

051409

051423

(9 dents/pouce - 9 teeth/inch) 062351

(15 dents/pouce - 15 teeth/inch) 062368

0.70 kg 051485

0.95 kg 051478

1.33 kg 051461

**BURR REMOVER - Outil d'ébavurage - Gratentferner**

**NEW**

079854

077270

Rubberised gripping - Manche en caoutchouc

**NEW**

MADE IN GERMANY

Corrosion resistant

x 10

**PLANISHING HAMMER BLACKTEC®**

077270

Rubberised gripping - Manche en caoutchouc

**NEW**

MADE IN GERMANY

Corrosion resistant

**CONTOUR GAUGE - Jauges de profil - Kontourenlehre**

052840

250 mm

057265

500 mm

**GAPPING GAUGES - Jauges de positionnement - Spaltmaßlehre**

x2 054752

**FENDER ROLLER TOOL SET - Outil de remise en forme passage de roue**

060791

**FORMING TOOLS - Outils de forme - Formgebungswerkzeuge**

051195

180 x 70 x 65 mm

280 x 95 mm

75 x 65 mm

280 x 95 mm

**BODY LINE TOOL - Traceur de ligne carrosserie - Markierhilfe für Kanten**

078758

**NEW**

170 mm max

Dry-wipe marker - Marqueur effaçable à sec

**FIXED HINGE BENDING TOOL - Redresseur de charnière de porte**

40 mm max

051102

Door hinge straightener - Redresseur de charnière de porte - Türgelenkausrichter

**LIP PLIER - Pince à lèvres - Falzzange gebogen**

079649

**NEW**

45 mm

**PLANISHING KIT FOR CAR BODY (SET OF 3 HAMMERS + 4 DOLLYS) - Kit marteaux et tas - Karosseriehammer & Handfaust Kit**

057579

40 x 40 mm 70 x 90 mm 1.4 kg 061408

117 x 57 mm 1.2 kg 061415

117 x 57 mm 1.2 kg 061422

**SET OF 30 TOOLS FOR SCRAPING/SANDING AND PAINT REMOVAL - Outils de dégarnissage et raclage - Polster & Schaber Kit**

057616

**HAND CHISEL FOR CAR BODY - Burins - Meißel für Karosserie**

26 x 7 mm 057586

26 mm

230 mm

60 x 11 mm 057593

60 mm

245 mm

**SET OF 3 CHISELS - Lot de 3 burins de séparation éléments collés - 3 Meißel**

076754

**NEW**

250 mm

300 mm

300 mm

**SET OF 4 NYLON CHISELS - Jeu de 4 burins en nylon - 4 Kunststoffmeißel**

054745

273 mm

19 mm (x1)

22 mm (x1)

25 mm (x1)

38 mm (x1)

**SET OF 3 SCRAPING KNIFES - Couteaux racloirs**

061439

15 mm

20 mm

30 mm

**AXIAL-GRIP PLIERS - Pinces axiales**

050242

Type I

Type J

Type JJ

Type W

Type LL

Type G

280 mm 061378

610 mm 061354

80 mm

410 mm

460 mm 061361

Flat nozzle - 610 mm 061347

240 mm

410 mm

**LOCK-GRIP PLIERS - Pinces étau mono serrage**

Flat nozzle - 460 mm 050112

240 mm

x 6

KIT: 050266

Flat nozzle 280 mm

x 3

x 3

x 5

x 5

= 16



**MINI DISC SANDER - Mini-meuleuse - Druckluftschleifer**

051829

Speed adjustment

Ø 75 mm

Speed rpm	Power W	dB	Air consumption l/min	Air pressure bar	cm	kg
18000	200	83	171	6.2	12	0.7

Included (x1) 052468

058248

MINI-FLEXIDISC LAMELLES ZIRCON Ø 50 mm

K 40 (x10) 058255  
K 60 (x10) 058262  
K 80 (x10) 058279

x2 Ø  
Ø 50 & 75 mm

Speed rpm	Power W	dB	Air consumption l/min	Air pressure bar	cm	kg
15000	84	91	6.2	10	0.6	

**AIR BELT SANDER - Ponceuse à bande à tête orientable - Druckluft Bandschleifer**

060906

360°

520 mm

20 mm

Grain 60 (x 5) 060913  
Grain 80 (x 5) 060920  
Grain 100 (x 5) 060937  
Grain 36 céramique (x 5) 062535

Speed rpm	Air consumption l/min	Air pressure bar	cm	kg
16 000	171	6.3	34	1.2

**AIR BELT SANDER - Ponceuse à bande à tête orientable - Druckluft Bandschleifer**

052819

360°

330 mm

10 mm

Grain 80 (x 10) 052833  
Grain 36 céramique (x 20) 062528

Speed rpm	Air consumption l/min	Air pressure bar	cm	kg
16000	171	6.3	26	0.9

**MINI ANGLE MILLING MACHINE - Mini-fraiseuse à renvoi d'angle - Mini-Winkelschleifer**

051836

90°

Speed rpm	Power W	dB	Air consumption l/min	Air pressure bar	cm	kg
18000	500	81	85	6.2	18	0.7

**AUTOMATIC MANDREL DRILL - Perceuse mandrin automatique - Druckluftbohrmaschine m. Schnellspannfutter**

051799

Ø 13

Speed rpm	Power W	dB	Air consumption l/min	Air pressure bar	cm	kg
800	300	92	170	6.2	18	0.9

**LONG HANDLED ANGLE GRINDER - Meuleuse d'angle - Druckluft-Winkelschleifer**

057753

Ø 100 mm

± 1.6 mm, x5 057883  
± 0.8 mm, x5 058217

Speed rpm	Power W	dB	Air consumption l/min	Air pressure bar	cm	kg
14000	84	113	6.2	37	1.7	

**MINI ANGLE GRINDER - Mini-meuleuse à renvoi d'angle - Mini-Druckluftwinkelschleifer geräuschgedämpft**

051867

90°

Ø 50 mm

(x1) 052772

Speed rpm	Power W	dB	Air consumption l/min	Air pressure bar	cm	kg
15000	200	86	85	6.2	18	0.75

**SAW FOR STRAIGHT CUT AND FILE - Scie coupe tôle droite et lime - Druckluftsäge und Feile**

051805

(x5) 052789

included 058750

Speed rpm	Power W	dB	Air consumption l/min	Air pressure bar	cm	kg
5000	—	85	255	6.2	10	0.8

**PNEUMATIC SURFACE REMOVER KIT - Coffret décapeuse pneumatique - Druckluftentrostler-Box inkl. Zubehör**

051775

Rubber wheel eraser - Roue gomme 115 x 14 mm 051874  
Stripping wheel - Roue à décaper 115 x 14 mm 051843  
Wire brush adaptor - Adaptateur pour brosse 051768

Fine brush Straight wipes - Brosse souple Brins droits 0.5 mm 103 x 23 mm 052598  
Coarse brush Curved fiber - Brosse dure Brins incurvés 0.7 mm 103 x 23 mm 051812  
Fine brush Curved fiber - Brosse souple Brins incurvés 0.5 mm 103 x 23 mm 051850

Speed rpm	Power W	dB	Air consumption l/min	Air pressure bar	cm	kg
4000	500	86	102	6.2	280	1.2

**MINI MILLING MACHINE - Mini Fraiseuse - Mini-Schleifer**

063228

Option Tungsten drill Ø 6 mm 054172

**LASER CORD METAL SHEET CUTTER (NIBBLER) - Dépointeuse pour cordon laser ACIER - Trennwerkzeug für Lasernähte**

054165

Ø 6 mm

STEEL Included 054172

**SPOT REMOVER - Dépointeuse - Druckluft-Schweißpunktbohrer**

SPOT DRILL 050464

360°

Ø 8

Included: Tungsten Carbide Ø 8 for BORON/UHSS (x1)

Spot remover drill - Forets de dépointage - Schweißpunktfräse Tungsten Carbide for BORON/UHSS

Speed rpm	Power W	dB	Air consumption l/min	Air pressure bar	cm	kg
800	400	85	140	6.5	35	2.3

**PNEUMATIC FLANGE / PUNCHING TOOL - Pince à soyer et à trouser, pneumatique - Pneumatische Loch- und Absattzange**

079892 Ø 8 mm  
052543 Ø 5 mm

0,8 > 1,2 mm NEW

2 in 1

0,8 > 1,2 mm

**BODY ZIPPER - Sertisseuse pneumatique - Pneumatic Crimper - Druckluftkantenformer**

056930

MADE IN HIGH QUALITY POLAND

1) MINI  
2) initial W  
3) final M x < 2.4mm  
4) final D x > 2.4mm

total thickness x=2a+b

Air pressure bar	cm	kg
5	28	2.1

**PACK SPOT DRILL + 140 mm 061460**

140 mm 061453

3-edge Ø 8 mm 053069

3-edge	Ø 8 mm	Ø 9 mm	Ø 10 mm
053069	069763	053076	
059849	069770		





**ANTISTATIC GUN**

- Pistolet antistatique - Pistola antistatica - Pistola antiestática

**NEW**

077010

Correct metal particles positioning, with ionisation  
- Position correcte des particules de métal après ionisation  
- Posizionamento corretto delle particelle con ionizzazione  
- Posicionamiento correcto de las partículas metálicas después de la ionización



included:



charger



support

**FILM COATING THICKNESS GAUGE**

- Détecteur épaisseur de peinture

059856

Measurement range : 0 - 1.80mm  
Resolution : 0.01mm / 1mm  
Measurement error : +/- 0.03 mm  
Power Supply : 2x 1.5V AAA batteries (included)  
Overall dimensions : 62 x 30.5 x 105 mm

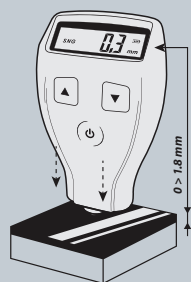

**AIR DUST EXTRACTOR** - Pneumatic dust vacuum cleaner for sander

Vacuum cleaner (without sander) - Aspirateur (sans ponceuse)  
073357  
350 x 800 x 400  
21 kg

Pneumatic Sander - Ponceuse pneumatique  
MIRKA PROS 650CV  
Ø 150 mm  
071346



- ✓ **ROBUST**
- ✓ **QUICK & SAFE**
- ✓ **LOW AIR CONSUMPTION**  
(5 bar)
- ✓ **NO ELECTRIC MOTOR**
- ✓ **ENERGY SAVING**

**INNOVATIVE SUCTION SYSTEM**

Depression 1150 mm H<sub>2</sub>O  
Air flow 600 l/min  
Air consumption 340 l/min



GYS PATENT BREVET GYS



ATEX norm Group II - Category 3

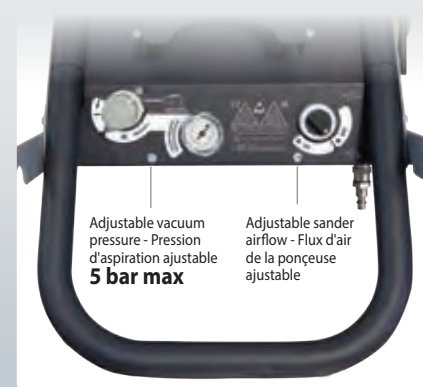

Adjustable vacuum pressure - Pression d'aspiration ajustable  
**5 bar max**

Adjustable sander airflow - Flux d'air de la ponceuse ajustable



Sander not included - Ponceuse non fournie

5 m  
Ø 29 mm

Option :  
10m  
Ø 29 mm  
076013

Sanding discs box\* - Rangement pour disques de ponçage\*  
\*discs box not included - disques de ponçage non inclus



High maneuverability and stability - Grande maniabilité et stabilité

**EASY ACCESS**

Maintenance free - Aucune maintenance



**Consumables**

Filter bag - Sac à poussières  
Capacity 5 kg  
Included x1  
x5  
058880



Included Earth clamp security

**ELECTRIC SANDER & POLISHER**

- Ponceuse /polisseuse électrique - Elektro-Polier-Schleifer

057999

Orbital 5.0 mm  
303 x 101 mm  
1.21 kg  
Speed : 4000, 7000, 9000 10000 rpm  
AC-in 220V - 230V / 50 - 60Hz

(( No vibration ))

Speed control



Ø 35

Ø 152 mm

Light weight & Compact

**PNEUMATIC ALUMINIUM DUST ATEX VACUUM CLEANER**

- Aspirateur pneumatique pour poussières alu (atex)

058866

Dust container capacity : 25 l  
Working compressed air pressure : 7 bar  
Compressed air consumption at 6 bar : 800 l/min  
Suction connection diameter size : 50 mm  
Max suction capacity : 150 m<sup>3</sup>/h  
Max vacuum level : 2000 mm H<sub>2</sub>O  
Recommended compressor power : 7.5 HP

74 x 45 x 45 mm  
18 kg



Manual or automatic

058293

Power supply : 230V / 50Hz  
Power : 1400W (max 2000W)  
Max. vacuum : 170 mbar  
Air flow : 2700 l/min  
Drum capacity : 30 L  
Drum material : stainless steel  
380 x 380 x 700 mm  
7 kg



4m  
Input Ø 32 mm  
Mains cable length 4.5m

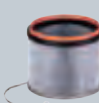

included  
Filtre - Filter  
075405



included  
Sac à poussières - Filter bag  
Capacity 5 kg  
x5  
058880



5 m  
Output Ø 29 mm  
Input Ø 35 mm



**HAND LAMPS - Lampes baladeuses - Handleuchte**

**Lampe BALADEUSE TRIPODE 250 L**  
100-250 lumens (x3)

3 x 1 W COB LED  
3 x 3.6 V - 300 mAh  
AAA rechargeable, Ni-MH  
USB charging (6h)  
**operating time**  
High position : 1 h  
Low position : 3 h  
Flashing : 5 h

↳ 260 x 100 x 100 mm

059955



**Lampe BALADEUSE 400 L**  
400 lumens

COB LED  
Li-ion  
Charging time : 8h  
**operating time**  
High position : 2.5 h  
Low position : 5 h  
Top light (1 W) : 6 h

↳ 230 x 65 x 40 mm

059153



**Lampe BALADEUSE PRO 600 L**  
250-600 lumens

COB LED, 80 CRI  
3.7 V - 2200 mAh Li-ion  
micro USB charging (3.5 h)  
**operating time**  
High position : 1.5 h,  
Mid position : 4.5 h,  
Top light (100 lumens) : 10 h

↳ 190 x 56 x 29 mm  
IP 54  
210 g

060883



**INSPECTION LAMPS**

- Lampes d'inspection - Inspektionslampen

**Lampe INSPECTION FRONTALE 280 L**  
100-280 lumens

3 W COB LED, 80 CRI+, 6500 K  
3.7 V - 1500 mAh Li-po  
micro USB charging  
mains charger not incl.  
**operating time**  
High position : 2 h  
Low position : 6 h  
IP 65  
110 g  
↳ 78.5 x 47.5 x 42 mm

060845

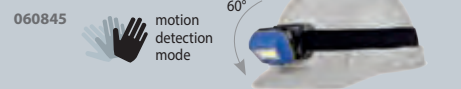

**Lampe AMBIANCE 360° PORTABLE 1000 L**  
60-1000 lumens

>80 CRI SMD LED  
6500 K  
3.7 V - 5200 mAh Li-ion  
USB charging (4.5h)  
USB power supply  
**operating time** 2 > 27 h

↳ 260 x 75 x 75 mm  
IP 54  
450 g

059764



**Lampe INSPECTION MINI 200 L**  
120-200 lumens

COB LED, 80 CRI, 6500 K  
3.7 V - 700 mAh Li-ion  
micro USB charging (2.5 h)  
mains charger not included  
**operating time**  
High position : 1.5 h  
Low position : 4 h  
Top light : 3.5 h  
IP 20  
76 g, ↳ 174 x 27.5 x 28 mm

060852

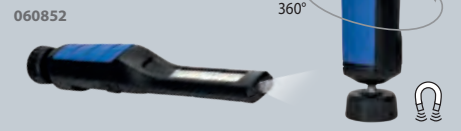

**Lampe INSPECTION MINI 350 L**  
0-350 lumens

COB LED  
3.7 V - 1100 mAh Li-ion  
USB charging (3 h)  
**operating time**  
3 > 6.5 h

IP 20

075894

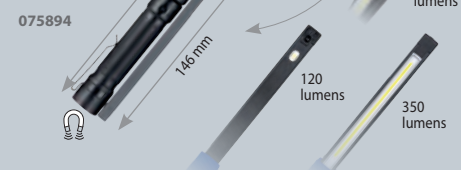

**Lampe INSPECTION PRO 600 L**  
0-600 lumens

COB LED  
6500 K  
3.7 V - 2600 mAh Li-ion  
USB charging (4 h)  
**operating time**  
1.5 > 15 h

↳ 380 x 40 x 45 mm  
300 g

057760

058309



**Lampe INSPECTION PRO 800 L**  
120-800 lumens

COB LED  
3.7 V - 2600 mAh Li-ion  
USB charging (4 h)  
**operating time**  
2.5 > 9 h

IP 54

075900

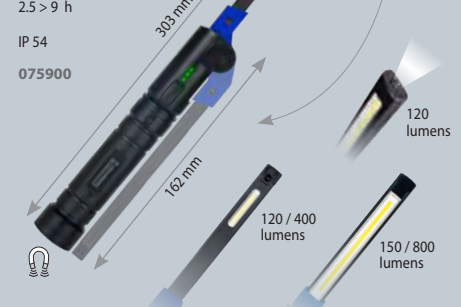

**UNDER BONNET LAMPS - Lampes sous capot - Leuchte für Motorhaube**

**Lampe SOUS CAPOT 600 L**  
500-1000 lumens

120 COB LED

3.7 V - 4000 mAh Li-ion  
charging time : 10/12 h

**operating time**  
High position : 4 h  
Low position : 8 h

1.7 kg

059962



**Lampe SOUS CAPOT 800 L**  
250-800 lumens

120 COB LED

3.7 V - 4000 mAh Li-ion  
charging time : 10/12 h

**operating time**  
High position : 3 h  
Low position : 6 h

058002



**LED WORKLIGHTS WITH TRIPOD - Projecteurs led sur trépied - LED-Arbeitsleuchte mit Standfuß**

**Lampe sur TRÉPIED 1800 L**  
1800 lumens

3x 55 COB LED  
total 165 LED

1.8 m power cord

059146

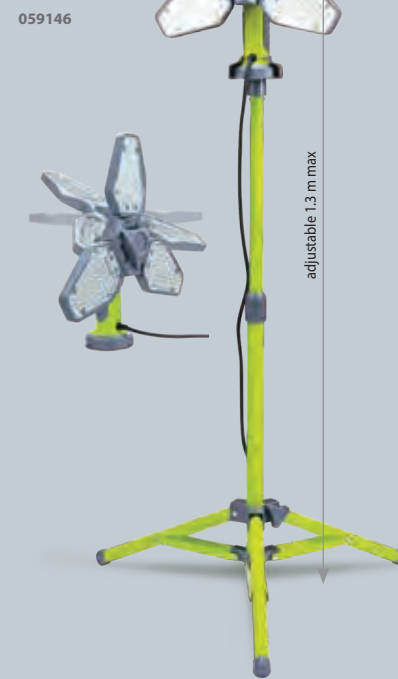

**Lampe sur TRÉPIED 3000 L**  
3000 lumens

35 W COB LED

2 m power cord

IP 44

059979



**Lampe sur TRÉPIED 4000 L**  
4000 lumens

3x 20 COB LED,  
total 60 LED

3 m power cord

059986



**DETAILING & COLOUR MATCH - Contrôle des couleurs - Fabnpassung & Aufbereitung**

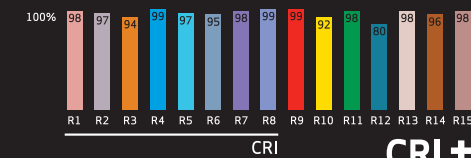

**4500 K**

**400 lumens**

**SUNCOLOR 1**  
COB LED, CRI > 95, 1100 lux  
3.7 V - 2600 mAh Li-ion  
USB charging  
**operating time** : 3 h  
↳ 190 x 56 x 29 mm  
290 g  
IP 65

058477



**3 COLORS**

**2700 - 4500 - 6500 K**

**350-420-450 lumens**

**SUNCOLOR 3**  
COB LED, 96 CRI+  
3.7 V - 2600 mAh Li-ion  
micro USB charging (4 h)  
**operating time** : 2.5/4 h  
IP 65  
↳ 190 x 56 x 29 mm, 290 g

060838



**5 COLORS**

**2700 - 3500 - 4500 - 5500 - 6500 K**

**500-1000-2000 lumens**

**SUNCOLOR 5**  
COB LED, 96 CRI+  
11.1 V - 4400 mAh Li-ion  
charger 110/240 V, 5 m cable, 15 V, 1.5 A  
charging time : 3.5 h  
**operating time**  
High position : 2 h, Mid : 4 h, Low : 8 h  
IP 65  
↳ 225 x 200 x 70 mm, 1.2 kg

060876

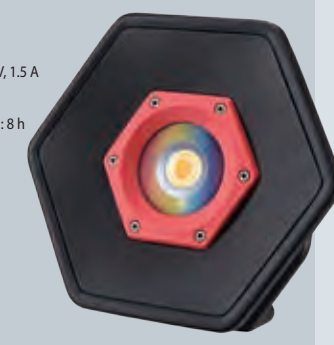

**5 COLORS**

**2500-3500-4500-5500-6500 K**

**250-500 lumens**

**SUNMATCH 3**  
COB LED, 96 CRI+, 700-1400 lux  
3.7 V - 2600 mAh Li-ion, USB charging  
**operating time** :  
High position : 2 h, Low position : 4 h  
IP 65  
↳ 204 x 89 x 81 mm, 270 g

061651

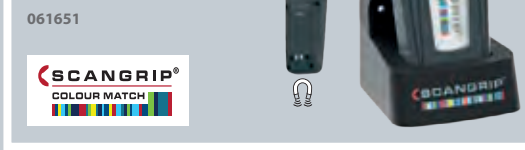

**UV CURING - SÉCHAGE UV -**

**UV LED λ 395-400 nm**

**Irradiance 6-15 mW/cm²**

**NOVA-UV S**

3.7 V - 5400 mAh Li-ion  
COB LED, 96 CRI+  
USB charger, 1 m cable, 5 V, 2 A  
charging time : 3.5 h  
curing area : Ø 20 cm  
**operating time** 1.5 h  
IP 67  
↳ 163 x 63 x 163 mm

061620





**FRAMES SUPPORT - Tréteaux - Klappböcke**

040601  
100.5 x 112 cm - 5.5 kg  
35 x 95 x 106 cm  
Ø28 mm  
Bent feet for grating  
- 4 pieds coudés  
Idéal sur caillbotis  
- Abgewinkelte Standfüße :  
Sicherer Stand auf Gittern u.ä.

040250  
100 x 105 cm - 7kg  
32 x 10 x 106 cm  
Ø32 mm

040311  
104.5 x 117 cm - 8.1kg  
32 x 10 x 106 cm  
Ø32 mm  
Suction pad for glazing  
- 4 ventouses  
Dépose vitrages  
- Gummiteiler zur Fixierung  
von Glasscheiben

040304  
104.5 x 108.8 cm - 8.1kg  
32 x 10 x 106 cm  
Ø32 mm  
Light and easy to handle  
Ideal for horizontal works  
- Léger et très maniable  
Spécial travaux à l'horizontal  
- Speziell geeignet für Arbeiten  
in horizontaler Position

Adjustable catenary - Chaînette réglable  
Protecting foam - Mousse de protection  
Non-slip base - Antidérapants

20 x 20 mm 16.5 kg  
MADE IN HIGH QUALITY POLAND

070677  
15 > 125 cm  
88 > 128 cm  
3 mm  
87 cm

**PREMIUM MASKING MACHINE**  
- Chariot de luxe marouflage  
- Abdeckpapier-Ständer

**MASKING MACHINE**  
- Chariot de marouflage - Abdeckpapier-Ständer

MADE IN HIGH QUALITY POLAND

OPTION

X 5 (not included)  
Paper roll - Rouleaux de papier - Papierständer  
30 > 120 cm  
Ø 75 mm  
Ø 250 mm

057333  
150 x 133 x 62 cm  
32 kg  
152 x 17 x 29 cm

Ø 40 mm x 6  
058897

X 3 (not included)  
Paper roll - Rouleaux de papier - Papierständer  
30, 60, 90 cm  
Ø 75 mm  
Ø 250 mm

056954  
150 x 62 x 110 cm - 12 kg  
122 x 29 x 17 cm

**STORAGE TROLLEY - Chariot de stockage - Lagerrollwagen**

**FLAP LOCK - Tiges de blocage**

040243  
71 x 90 x 197 cm  
41 kg  
x2 : 90 x 6 x 147 cm + 97 x 74 x 24 cm

056732  
30 > 115 cm

**ROTARY ELEMENT SUPPORT - Support pare-chocs - Lackierständer für Stoßstange, einstellbar**

052376  
91 x 105 cm - 7.6 kg  
60 x 11 x 75 cm

059825  
106 x 104 x 215 cm - 32.5 kg  
112 x 31.5 x 21.5 cm + 12 x 9.5 x 194.5 cm

50 x 150 cm - 13 kg  
152 x 15.5 x 11.5 cm

Adapted to wing mirror covers - Adapté aux coques de rétroviseurs - Geeignet für Außenspiegel

**UNIVERSAL SUPPORT - Chariot pour éléments de carrosserie - Universelle Ständer**

066281  
20 kg

MADE IN HIGH QUALITY POLAND

max 80 kg  
Ø 4.5 cm  
Ø 12.5 cm  
80 cm  
70-100 cm  
115 cm

**MOBILE WORKSTATION - Table de travail mobile**

079465  
1670 x 750 x 930 cm - 38 kg

NEW

290 mm

100 kg max  
1170 mm

750 mm  
390 mm  
1030 mm

**WORKSTATION 3 SHELVES - Servante 3 plateaux**

068056

65 kg max  
835 mm  
65 kg max  
65 kg max  
390 mm  
800 mm

**WORKSTATION PREMIUM 5 DRAWERS - Servante premium 5 tiroirs**

076143

NEW 06/2023

1000 mm  
500 mm  
940 mm

**ROTARY ELEMENT SUPPORT - Support élément rotatif - Lackierständer für Stoßstange, einstellbar**

MADE IN HIGH QUALITY POLAND

052611  
200 x 101 cm - 17.5 kg  
35 x 15 x 110 cm  
Made in China

PRO 056725  
200 x 105 x 81 cm - 22 kg  
24 x 17 x 118 cm

Locking of the axis - Verrouillage de l'axe - Verriegelung der Achse

1.5 mm  
360°  
2 mm

**EXTENDABLE SUPPORT - Chariot extensible pour éléments de carrosserie - Ausziehbarer Wagen**

061507  
26 kg  
114.5 x 42 x 13.5 cm

MADE IN HIGH QUALITY POLAND

max 150 kg  
100 cm  
135 - 210 cm

**ROUND STOOL WITH TOOL STORAGE - Tabouret - Werkstatt-Rollhocker**

057555  
38 x 38 x 44 cm - 6 kg  
40 x 40 x 18 cm

max : 50 cm  
min : 38 cm

**MECHANICS CREEPER WITH TILTING HEADREST - Chariot de visite - Werkstatt-Rollliege**

057548  
102 x 43 x 11 cm  
7.2 kg  
11 x 44 x 13 cm

**2 IN 1 MECHANICS CREEPER - Chariot de visite 2 en 1 - Werkstatt-Rollliege**

079861  
102 x 40 x 14 cm  
40 x 13 x 63 cm - 7,6 kg

NEW

2

**ROUND STOOL WITH STORAGE - Tabouret d'atelier 3 tiroirs**

079878  
47 x 35 x 43 cm  
38.5 x 37 x 38.5 cm - 13 kg

NEW

**FOLDING STEP STOOL - Marche pied (Aluminium) - Arbeitspodest klappbar**

057562  
8.2 kg  
102 x 41 x 59 cm

ALU 150 kg

960 mm  
385 mm  
475 mm

**ALU 150 kg**

058552  
15,5 Kg  
116 x 43 x 17 cm - 16.5 kg

1090 > 1750 mm  
520 > 900 mm  
300 mm



**HEAT COVER** - Couverture anti-chaueur - Hitzeschutzdecke - Manta anti-calor - Protecção anti-aquecimento

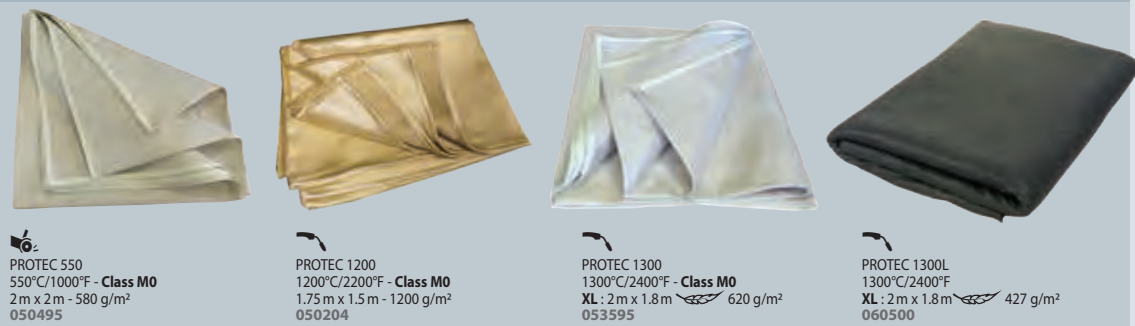

PROTEC 550  
550°C/1000°F - Class M0  
2m x 2m - 580 g/m²  
050495

PROTEC 1200  
1200°C/2200°F - Class M0  
1.75m x 1.5m - 1200 g/m²  
050204

PROTEC 1300  
1300°C/2400°F - Class M0  
XL: 2m x 1.8m - 620 g/m²  
053595

PROTEC 1300L  
1300°C/2400°F  
XL: 2m x 1.8m - 427 g/m²  
060500

**SET OF 2 MAGNETS**

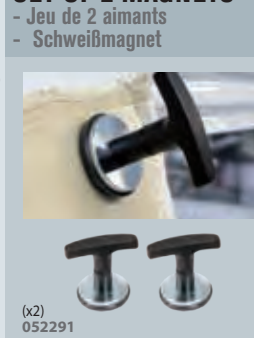

- Jeu de 2 aimants  
- Schweißmagnet  
(x2)  
052291

**MAGNETIC COVER** - Couverture magnétique - Magnetschutzdecke



1.06m x 0.6m  
061446

**RIDEAU DE SOUDAGE** - Welding curtain and frame - Schweißerschutzwand

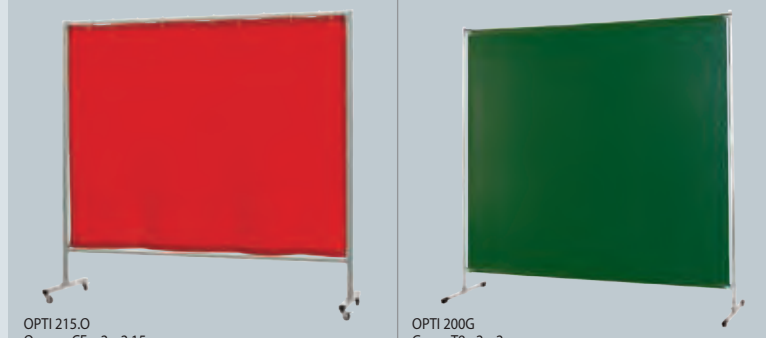

OPTI 215.0  
Orange CE - 2 x 2.15 m  
EN 25980 - 2015/01  
060470

OPTI 200G  
Green T9 - 2 x 2 m  
EN 25980 - 2015/01  
060463

**RESPIRATORY MASKS** - Masques respiratoires - Atemschutzmaske - Máscaras respiratorias



FFP3 - EN 140 / EN 143 / EN 166  
(x1) Size M/L  
037021

FFP3 - EN 140 / EN 143  
(x1) Size M/L  
037014

Case / Étui  
037045

FFP3 - EN 143 : 2000 P3  
Anti poussières / Anti odeurs  
037038

**PROTECTION GOGGLES**



EN 166

Shade/IR0  
042810

Shade/IR0  
042827

Shade/IR5  
042841

Shade/IR0  
047778

Shade/IR0  
047792

Shade/IR0  
042865

Shade/IR0  
047839

**GLOVES** - Gants - Handschuhe - Guantes



Anti-cut  
Anti coupure  
T9  
045897

✓ touch screen friendly  
- écran tactile  
High resistance anti-cut  
Anti coupure haute résistance  
EN 420  
EN 388:4121  
T9: 045910  
T10: 045927

High dexterity anti-cut  
- Anti coupure haute dextérité  
EN 420  
EN 388:1121  
T9: 045903  
T10: 045934

T10  
064188

EN420  
2003

EN388  
2003

EN388  
4342

EN388  
4244

EN 407  
424X4X  
EN12477  
Class: A1

Heavy Duty T10  
(MMA - MIG - Plasma)  
045101

Gants PRO TIG  
T10  
045194

EN 407  
322X2X  
EN12477  
Class: A1

EN388  
2011XX

EN 407  
41313X  
EN12477-B  
EN 420

EN388  
4244

Reinforced welding gloves  
- Gants de soudage renforcés  
T10  
045873

Gants PRO TIG EXTRA  
T10  
045323

EN 407  
41313X  
EN12477-B  
EN 420

**MULTI-USE LEATHER APRON**



- Tablier cuir multi-usage  
- Delantal de cuero multi-uso  
- Mehrzweck-Lederschürze

PRO  
045217

**EQUIPMENT FOR OPERATIONS ON ELECTRIC AND HYBRID VEHICLES** - Équipements pour opérations sur véhicules électriques & hybrides - Ausrüstung für den Betrieb von Elektro- und Hybridfahrzeugen

**FACE SHIELD WITH HEADBAND**



- ÉCRAN FACIAL AVEC SERRE-TÊTE  
068018

**INSULATING GLOVES (T10)**



- GANTS ISOLANTS (T10)  
068025

**25 pieces insulated tools 1000V** - Coffret de 25 outils isolés 1000V



- Box mit 25 isolierten Werkzeugen 1000V  
066489

7/8/10/12/14/15/17/19/22 mm sockets - Douilles 7/8/10/12/14/15/17/19/22 mm	x 9
175 mm universal pliers in chrome vanadium - Pince universelle de 175 mm en chrome vanadium	x 1
Cutting pliers 150 mm in chrome vanadium - Pince coupante 150 mm en chrome vanadium	x 1
3/8" ratchet - Cluqiet en 3/8"	x 1
Extension 100 mm - Rallonge 100 mm	x 1
T-handle - Poignée en T	x 1
Open ended wrenches 7/8/10/12/14/17 mm - Clés plates à fourches 7/8/10/12/14/17 mm	x 6
Cable knife - Couteau pour câble	x 1
Philips PhH1x100/PhH2x100 mm screwdriver - Tournevis Philips PhH1x100/PhH2x100 mm	x 2
Flat screwdriver 5.5x125 / 4x100 mm - Tournevis plats 5.5x125/4x100 mm	x 2



**Kit for marking the area of intervention**

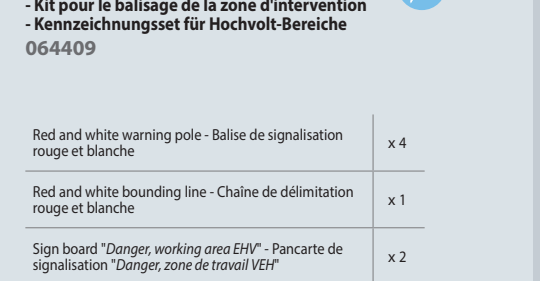

- Kit pour le balisage de la zone d'intervention  
- Kennzeichnungsset für Hochvolt-Bereiche  
064409

Red and white warning pole - Balise de signalisation rouge et blanche	x 4
Red and white bounding line - Chaîne de délimitation rouge et blanche	x 1
Sign board "Danger, working area EHV" - Pancarte de signalisation "Danger, zone de travail VEH"	x 2



**TROUSER** - Pantalon - Hose



98% cotton, 2% antistatic

EN ISO 11611  
Class 2-A1 & A2

EN ISO 11612  
A1+A2-B1-C1-E3-F1

IEC 61482-2  
Class 1-4kA

EN 1149-5

EN 14404  
+A1  
Type 2

S (40/42)  
046368

M (44/46)  
046375

L (48/50)  
046382

XL (52/54)  
046399

XXL (56/58)  
046412

**JACKET** - Veste - Jacke



98% cotton, 2% antistatic

EN ISO 11611  
Class 1-4kA

EN ISO 11612  
A1+A2-B1-C1-E3-F1

EN 1149-5

EN 14404  
+A1  
Type 2

EN ISO 11611  
Class 2-A1 & A2

EN 1149-5

S (40/42)  
046313

M (44/46)  
046320

L (48/50)  
046337

XL (52/54)  
046344

XXL (56/58)  
046351





## A premium international brand for dedicated professionals

Une marque internationale pour les Professionnels de la réparation carrosserie

Eine internationale Marke für Karosserie-Reparatur-Profis

Un marchio internazionale per i professionisti della riparazione della carrozzeria

Una marca internacional para los profesionales de la reparación de carrocería

Et førende internationalt mærke for målbevidste fagfolk



Distributed by :



Non-contractual document. JBDC reserves the right to modify the specifications of its machines without notice. - Document non contractuel. JBDC se réserve le droit de modifier sans préavis les spécifications de ses appareils - Änderungen und Irrtümer vorbehalten. JBDC behält sich das Recht vor, technische Daten von Geräten ohne vorherige Mitteilung zu ändern. - Documento non contrattuale. JBDC si riserva il diritto di modificare senza preavviso le caratteristiche dei suoi dispositivi. - Documento no contractual. JBDC se reserva el derecho a modificar las especificaciones de sus equipos, sin previo aviso. - Niet-contractueel document. JBDC behoudt zich het recht voor technische gegevens van de producten zonder voorafgaande melding te veranderen.

095908